

B - Kata F Cad
Trofeo Toscana Primavera

Tatami
4

Pool
1/1

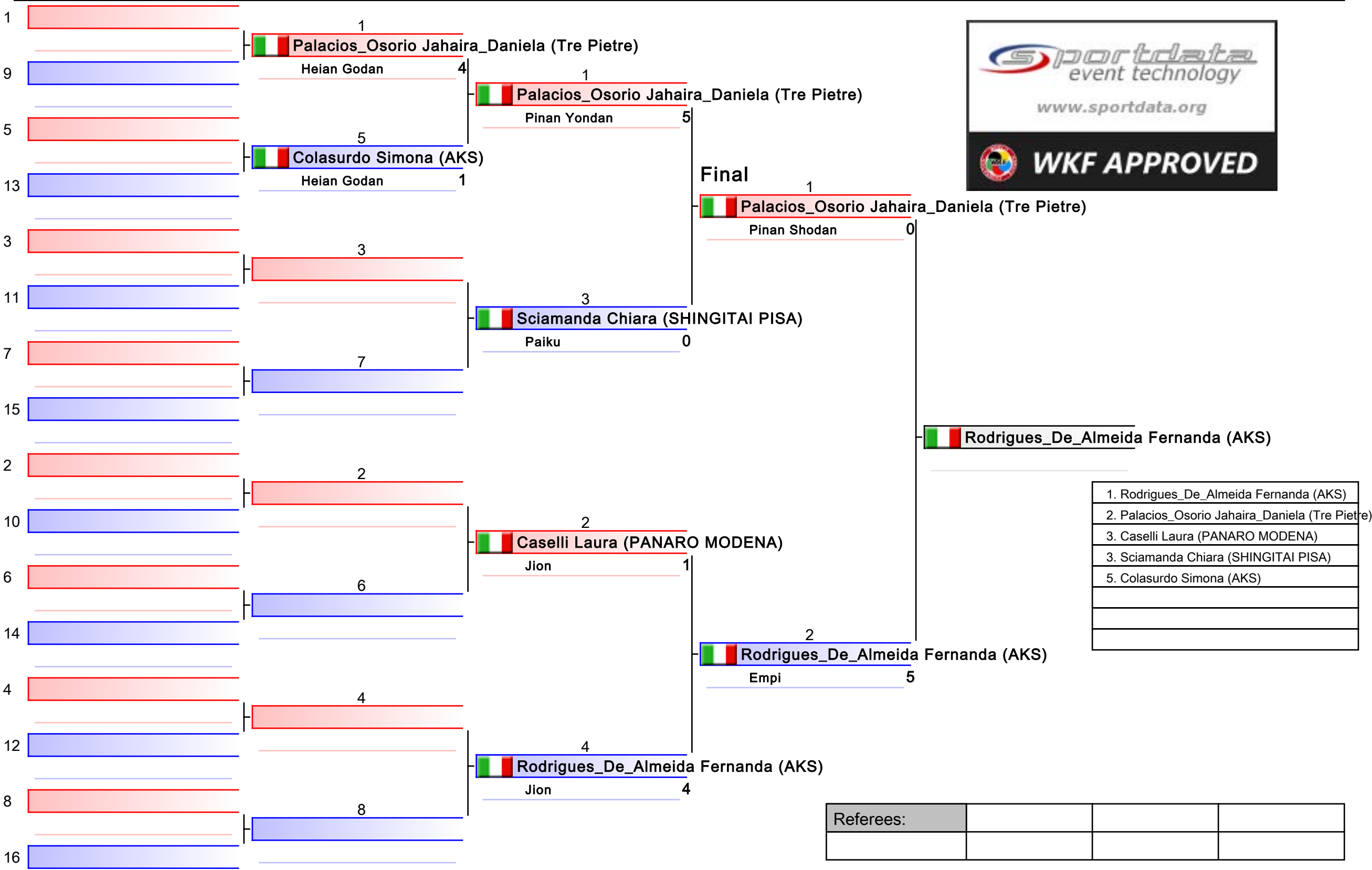

1. Rodrigues_De_Almeida Fernanda (AKS)
2. Palacios_Osorio Jahaira_Daniela (Tre Pietre)
3. Caselli Laura (PANARO MODENA)
3. Sciamanda Chiara (SHINGITAI PISA)
5. Colasurdo Simona (AKS)

Referees:			

B - Kata F Es.A
Trofeo Toscana Primavera

Tatami
1

Pool
1/1

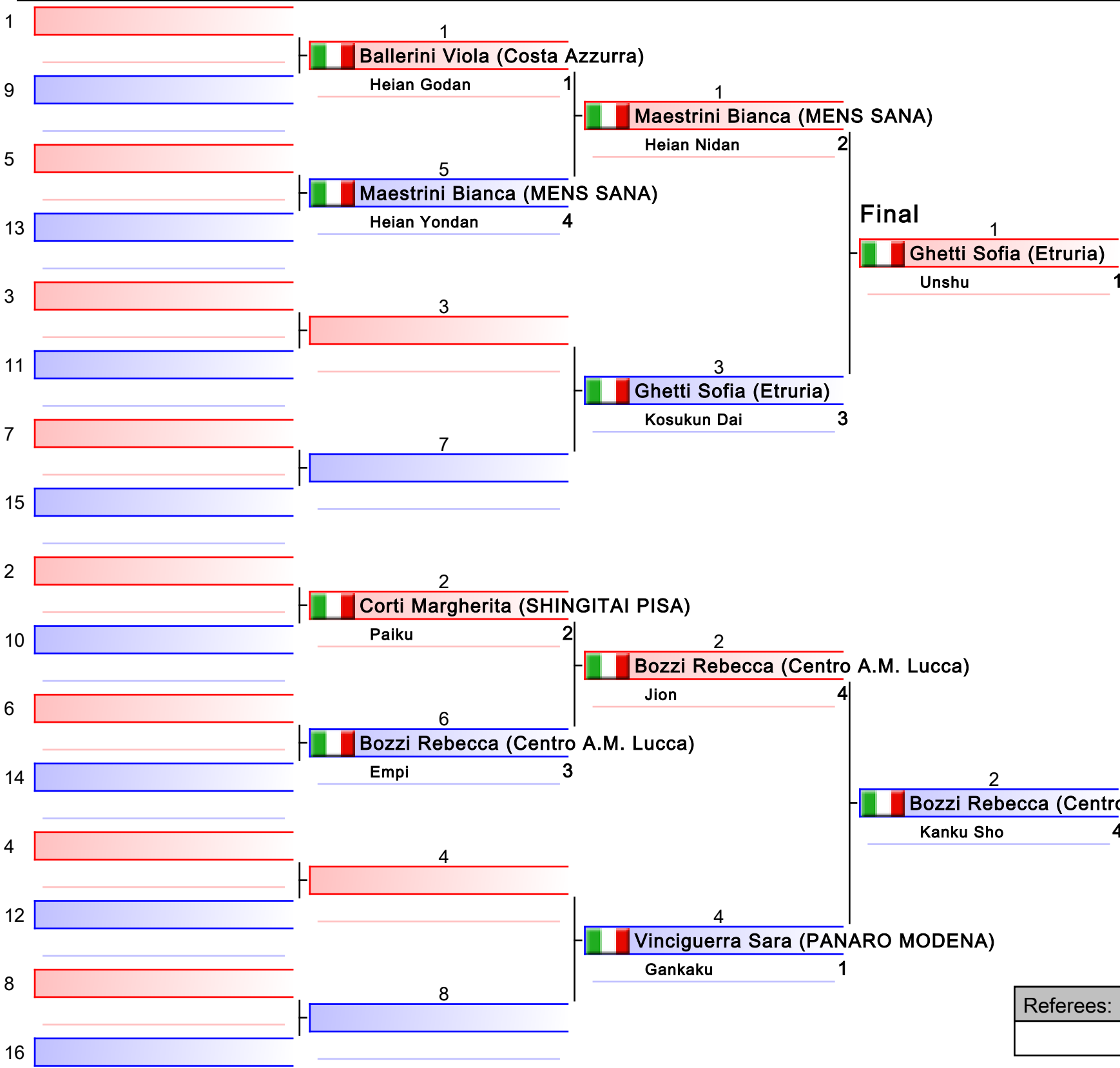

1. Bozzi Rebecca (Centro A.M. Lucca)
2. Gheti Sofia (Etruria)
3. Maestrini Bianca (MENS SANA)
3. Vinciguerra Sara (PANARO MODENA)
5. Corti Margherita (SHINGITAI PISA)

Referees:			

B - Kata F Es.B
Trofeo Toscana Primavera

Tatami
3

Pool
1/1

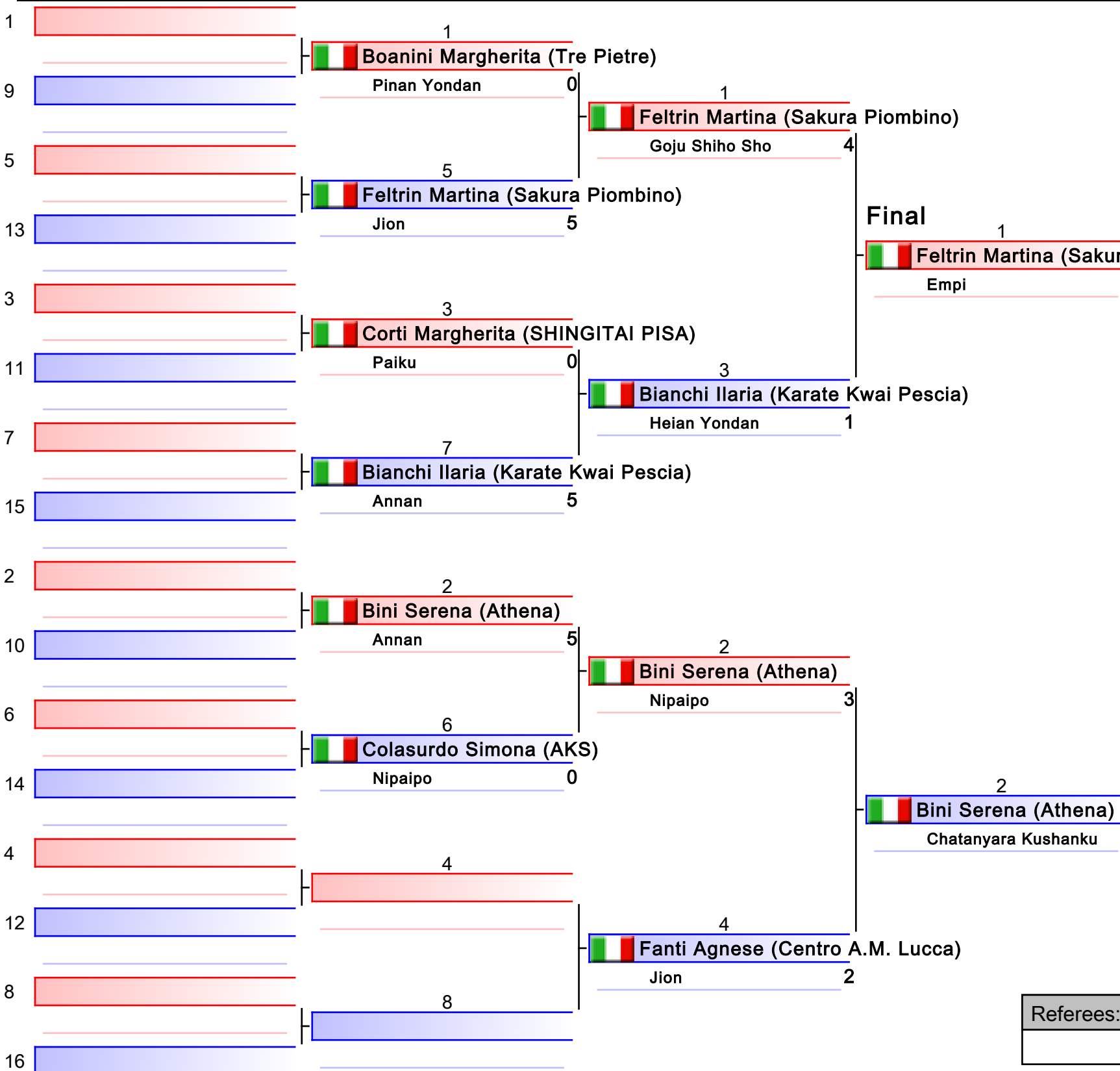

1. Bini Serena (Athena)
2. Feltrin Martina (Sakura Piombino)
3. Bianchi Ilaria (Karate Kwai Pesca)
3. Fanti Agnese (Centro A.M. Lucca)
5. Boanini Margherita (Tre Pietre)
5. Colasurdo Simona (AKS)

Referees:			

B - Kata F Juniores
Trofeo Toscana Primavera

Tatami **1**
Pool **1/1**

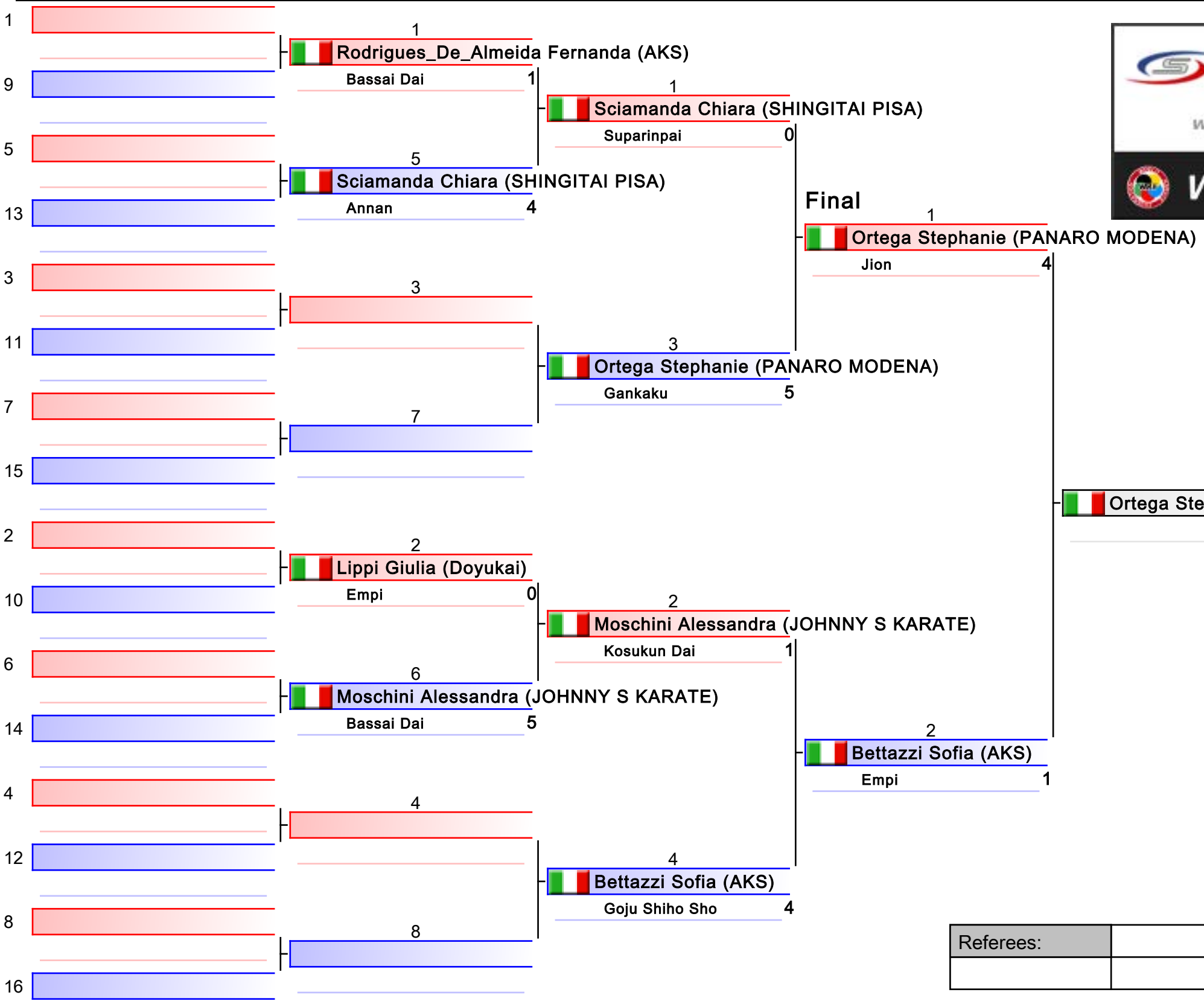

1. Ortega Stephanie (PANARO MODENA)
2. Bettazzi Sofia (AKS)
3. Sciamanda Chiara (SHINGITAI PISA)
3. Moschini Alessandra (JOHNNY S KARATE)

Referees:			

B - Kata F Sen - Round Robin (each against each)

Trofeo Toscana Primavera

Tatami
2

Pool
1/1

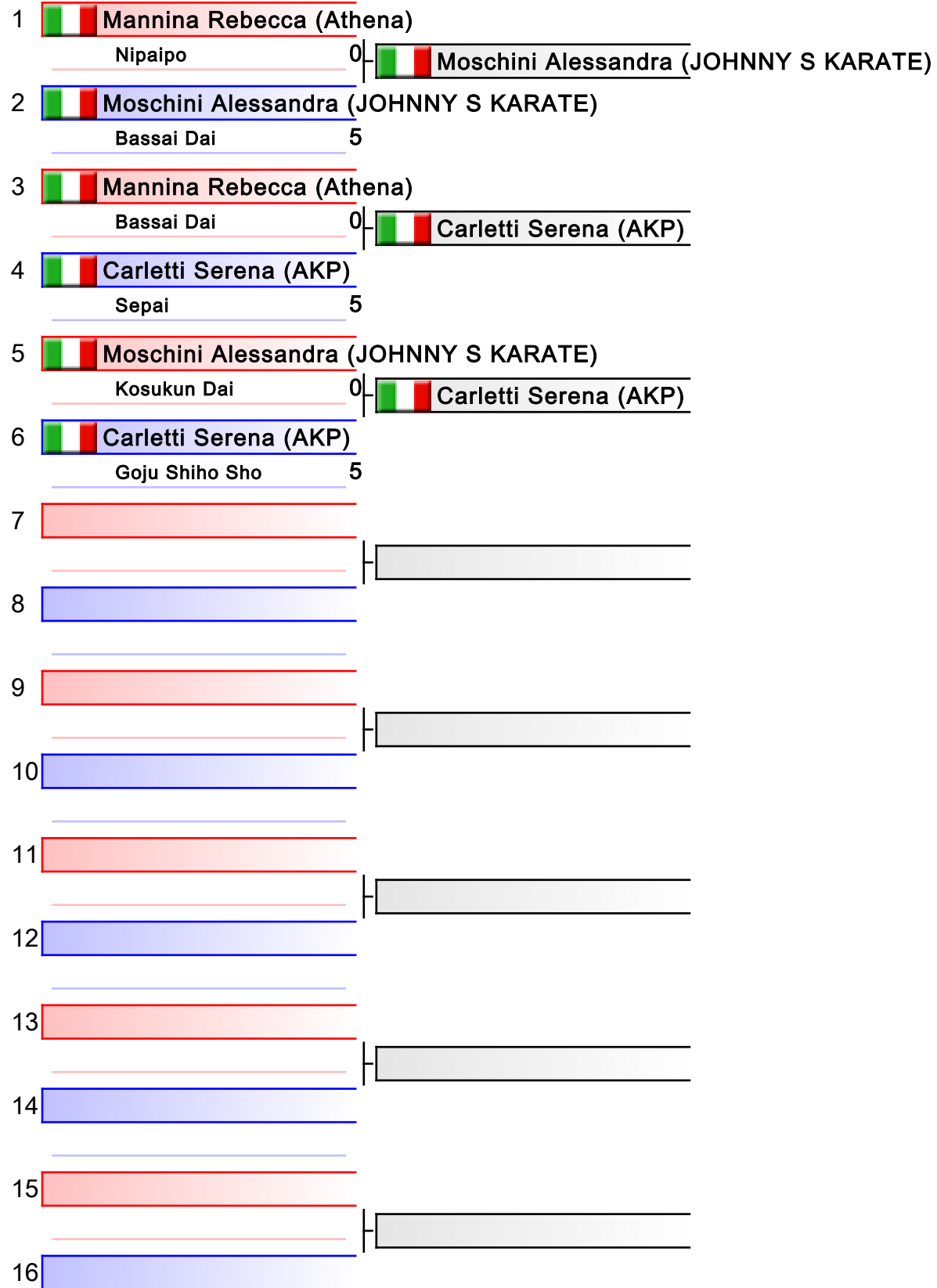

1. Carletti Serena (AKP)
2. Moschini Alessandra (JOHNNY S KARATE)
3. Mannina Rebecca (Athena)

Referees:			

B - Kata M Cad
Trofeo Toscana Primavera

Tatami
3

Pool
1/1

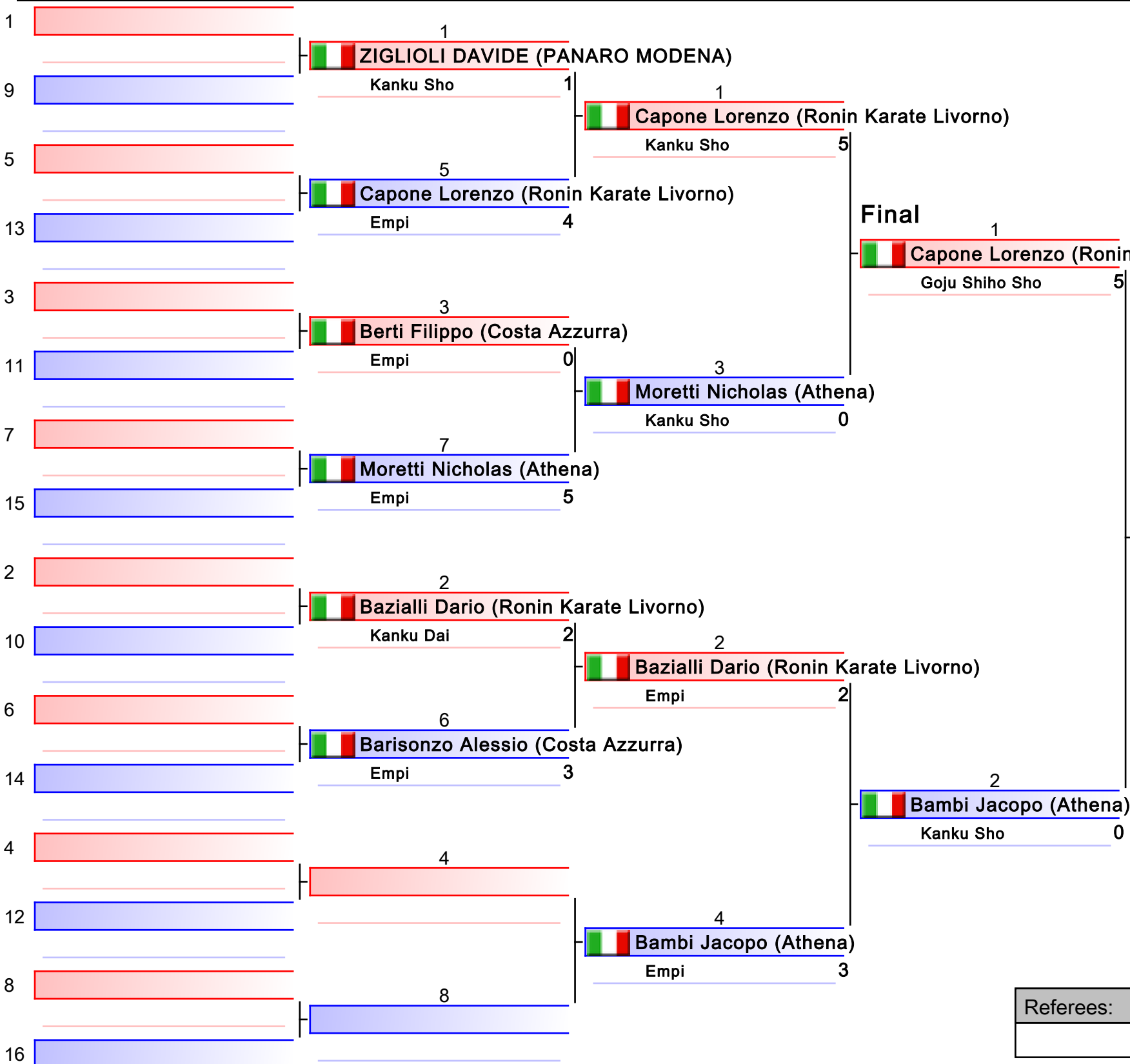

1. Capone Lorenzo (Ronin Karate Livorno)
2. Bambi Jacopo (Athena)
3. Bazialli Dario (Ronin Karate Livorno)
3. ZIGLIOLI DAVIDE (PANARO MODENA)
5. Moretti Nicholas (Athena)









Referees:			

B - Kata M Es.A - Round Robin (each against each)

Trofeo Toscana Primavera

Tatami
2

Pool
1/1

1	 Morelli Giacomo (Ronin Karate Livorno)	Empi	5	 Morelli Giacomo (Ronin Karate Livorno)
2	 D_Agostino Francesco (09AR3403)	Jion	0	
3	 Morelli Giacomo (Ronin Karate Livorno)	Jion	5	 Morelli Giacomo (Ronin Karate Livorno)
4	 Cioncolini Thomas (Accad Karate Sh Valdarno)	Heian Yondan	0	
5	 D_Agostino Francesco (09AR3403)	Empi	5	 D_Agostino Francesco (09AR3403)
6	 Cioncolini Thomas (Accad Karate Sh Valdarno)	Heian Sandan	0	
7				
8				
9				
10				
11				
12				
13				
14				
15				
16				



1. Morelli Giacomo (Ronin Karate Livorno)
2. D_Agostino Francesco (09AR3403)
3. Cioncolini Thomas (Accad Karate Sh Valdarno)

Referees:			

B - Kata M Es.B
Trofeo Toscana Primavera

Tatami
2

Pool
1/1

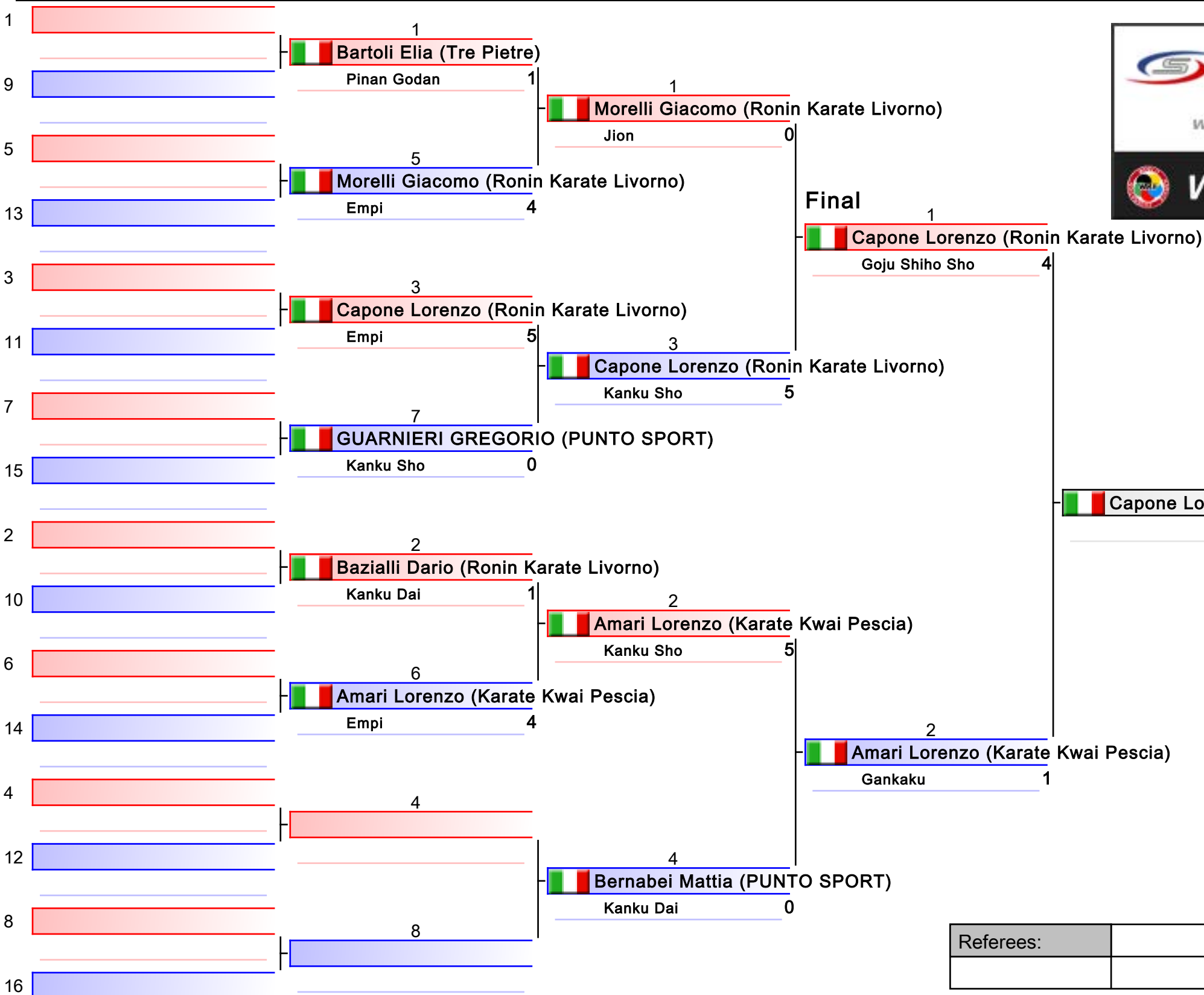

- | |
|-------------------------------------------|
| 1. Capone Lorenzo (Ronin Karate Livorno) |
| 2. Amari Lorenzo (Karate Kwai Pescia) |
| 3. Morelli Giacomo (Ronin Karate Livorno) |
| 3. Bazialli Dario (Ronin Karate Livorno) |
| 5. GUARNIERI GREGORIO (PUNTO SPORT) |
| 5. Bernabei Mattia (PUNTO SPORT) |
| |
| |

Referees:			

B - Kata M Juniores
Trofeo Toscana Primavera

Tatami
1

Pool
1/1

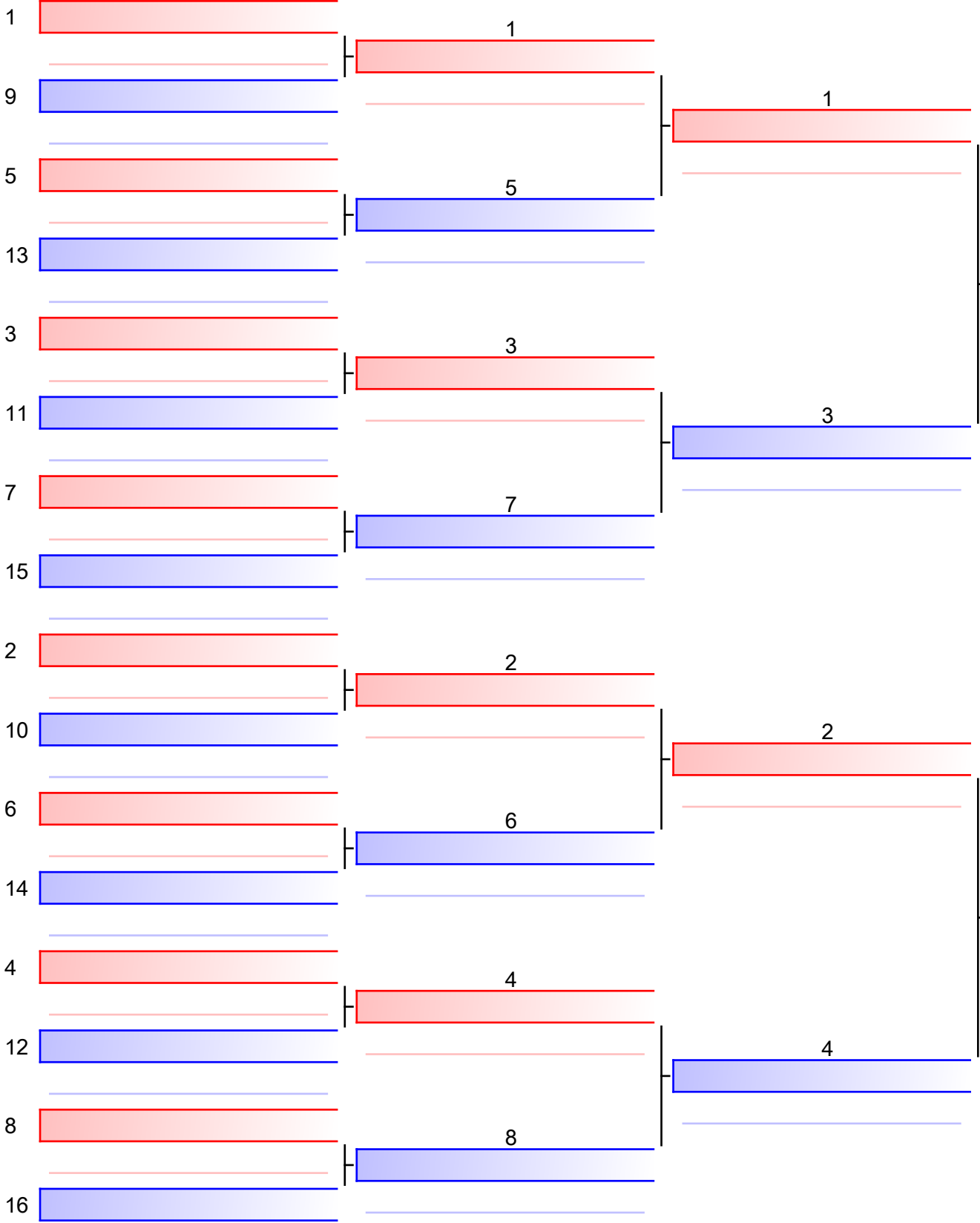

Final

Bonini Riccardo (Dai Karate Club)

Sochin 5

Bonini Riccardo (Dai Karate Club)

Collesei Marco (PUNTO SPORT)

Sochin 0

1. Bonini Riccardo (Dai Karate Club)
2. Collesei Marco (PUNTO SPORT)









Referees:			

B - Kata M Sen - Round Robin (each against each)

Trofeo Toscana Primavera

Tatami
1

Pool
1/1

1	 Bonini Riccardo (Dai Karate Club) Sochin 3	 Bonini Riccardo (Dai Karate Club)
2	 Mastroianni Filippo (Etruria) Kosukun Dai 2	
3	 Bonini Riccardo (Dai Karate Club) Empi 1	 MASSAI MICHELE (Athena)
4	 MASSAI MICHELE (Athena) Gojushiho 4	
5	 Mastroianni Filippo (Etruria) Nipaipo 2	 MASSAI MICHELE (Athena)
6	 MASSAI MICHELE (Athena) Sochin 3	
7		
8		
9		
10		
11		
12		
13		
14		
15		
16		



1. MASSAI MICHELE (Athena)
2. Bonini Riccardo (Dai Karate Club)
3. Mastroianni Filippo (Etruria)

Referees:			

B - Kumite F CAD 48 Kg - Round Robin (each against each)

Trofeo Toscana Primavera

Tatami
1

Pool
1/1

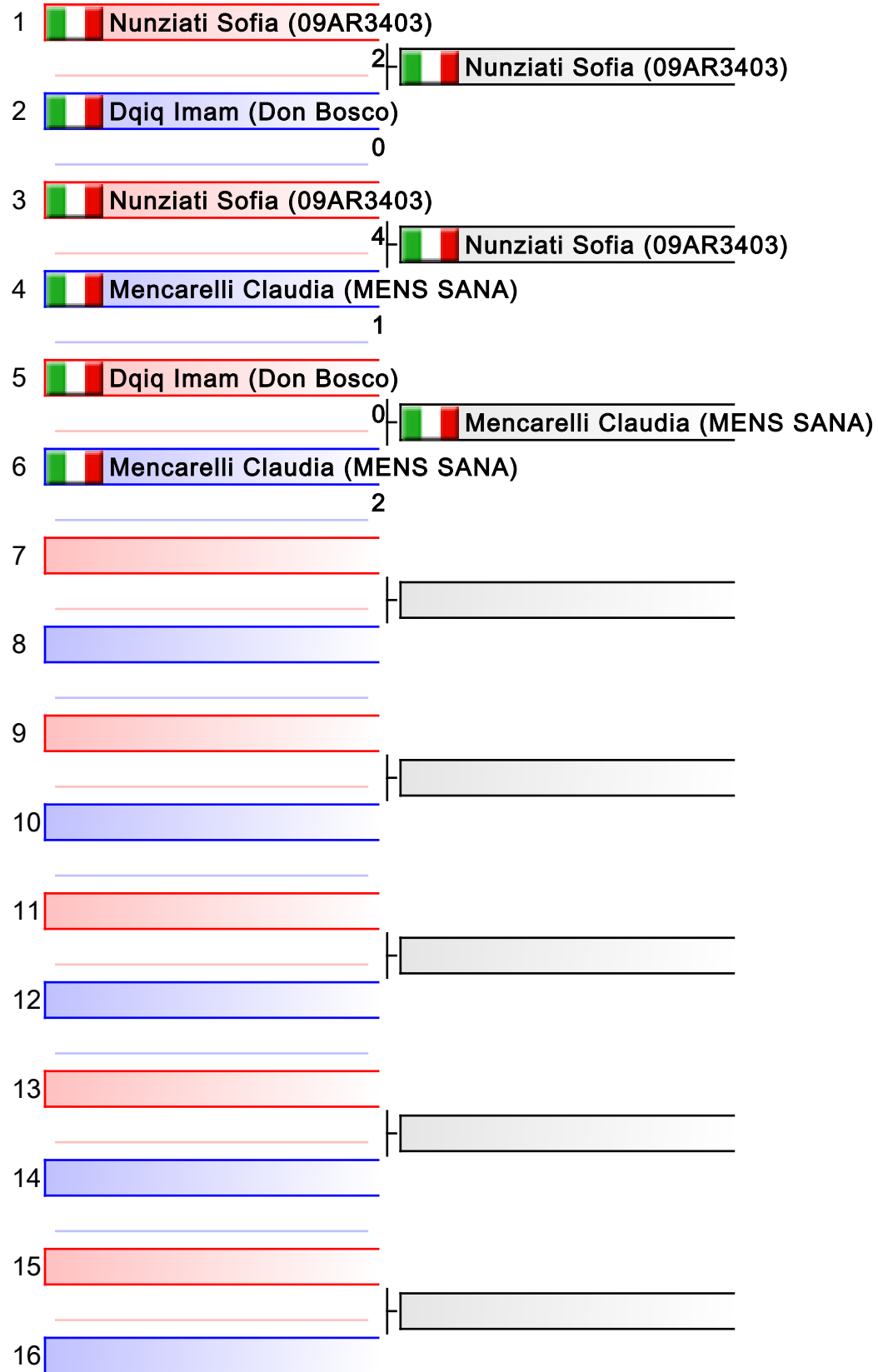

1. Nunziati Sofia (09AR3403)
2. Mencarelli Claudia (MENS SANA)
3. Dqiq Imam (Don Bosco)

Referees:			

B - Kumite F Cad 53 Kg - Round Robin (each against each)

Trofeo Toscana Primavera

Tatami

Pool
1/1

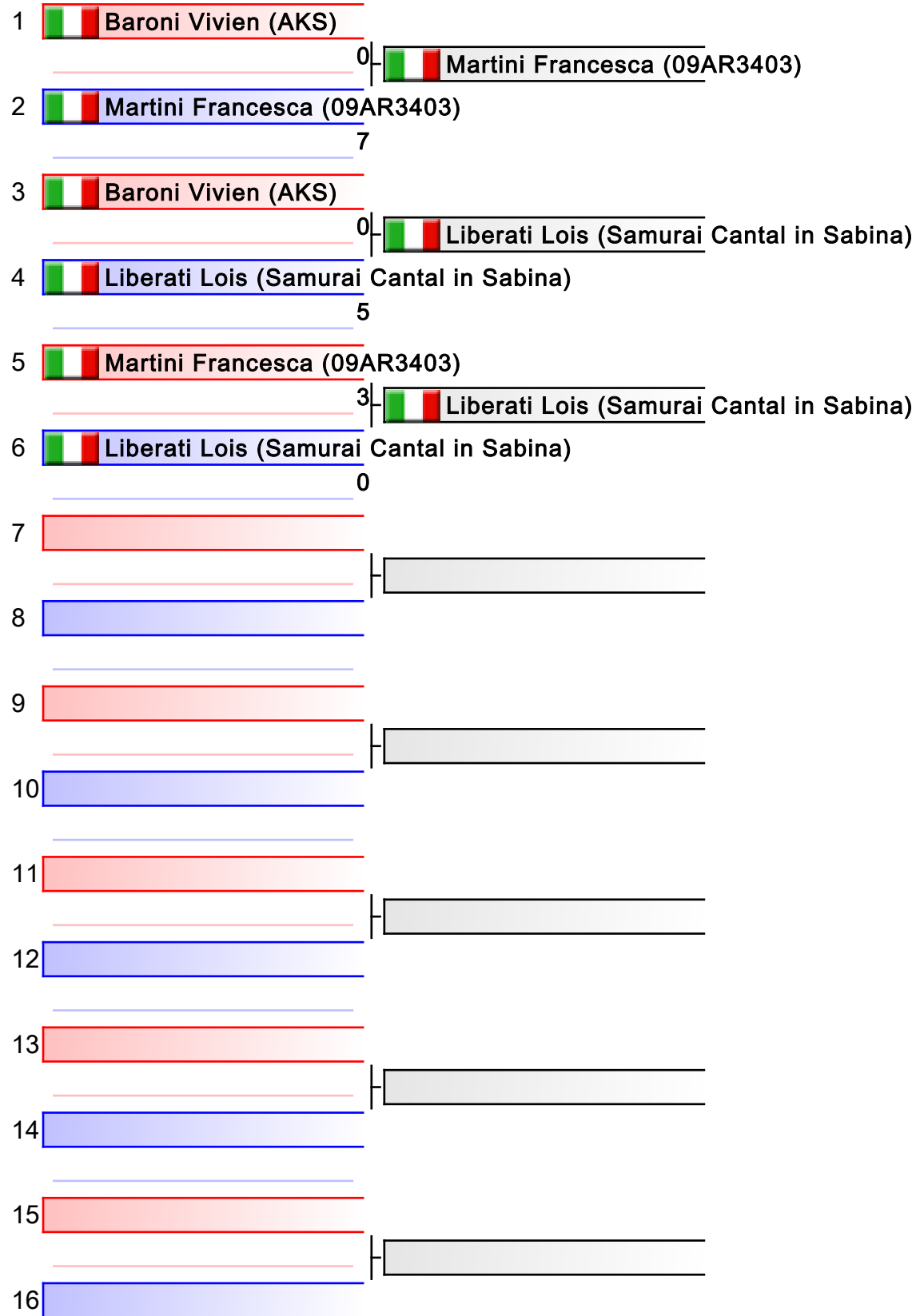

1. Liberati Lois (Samurai Cantal in Sabina)
2. Martini Francesca (09AR3403)
3. Baroni Vivien (AKS)

Referees:			

B - Kumite F Es.A 32-37 Kg
Trofeo Toscana Primavera

Tatami **3** Pool **1/1**

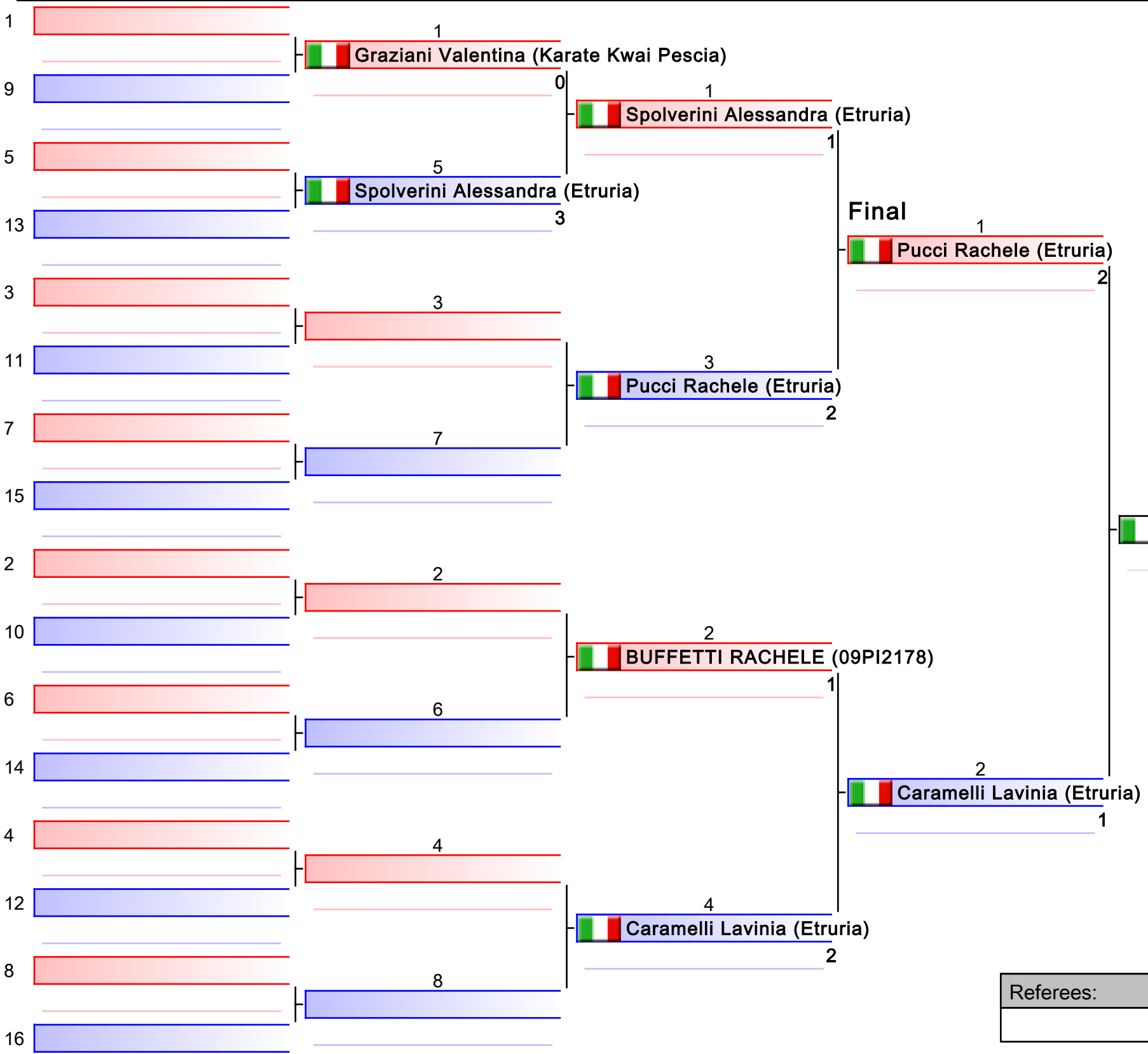

1. Pucci Rachele (Etruria)
2. Caramelli Lavinia (Etruria)
3. Spolverini Alessandra (Etruria)
3. BUFFETTI RACHELE (09PI2178)

Referees:			

B - Kumite F Es.A 47 Kg

Trofeo Toscana Primavera

Tatami
4

Pool
1/1

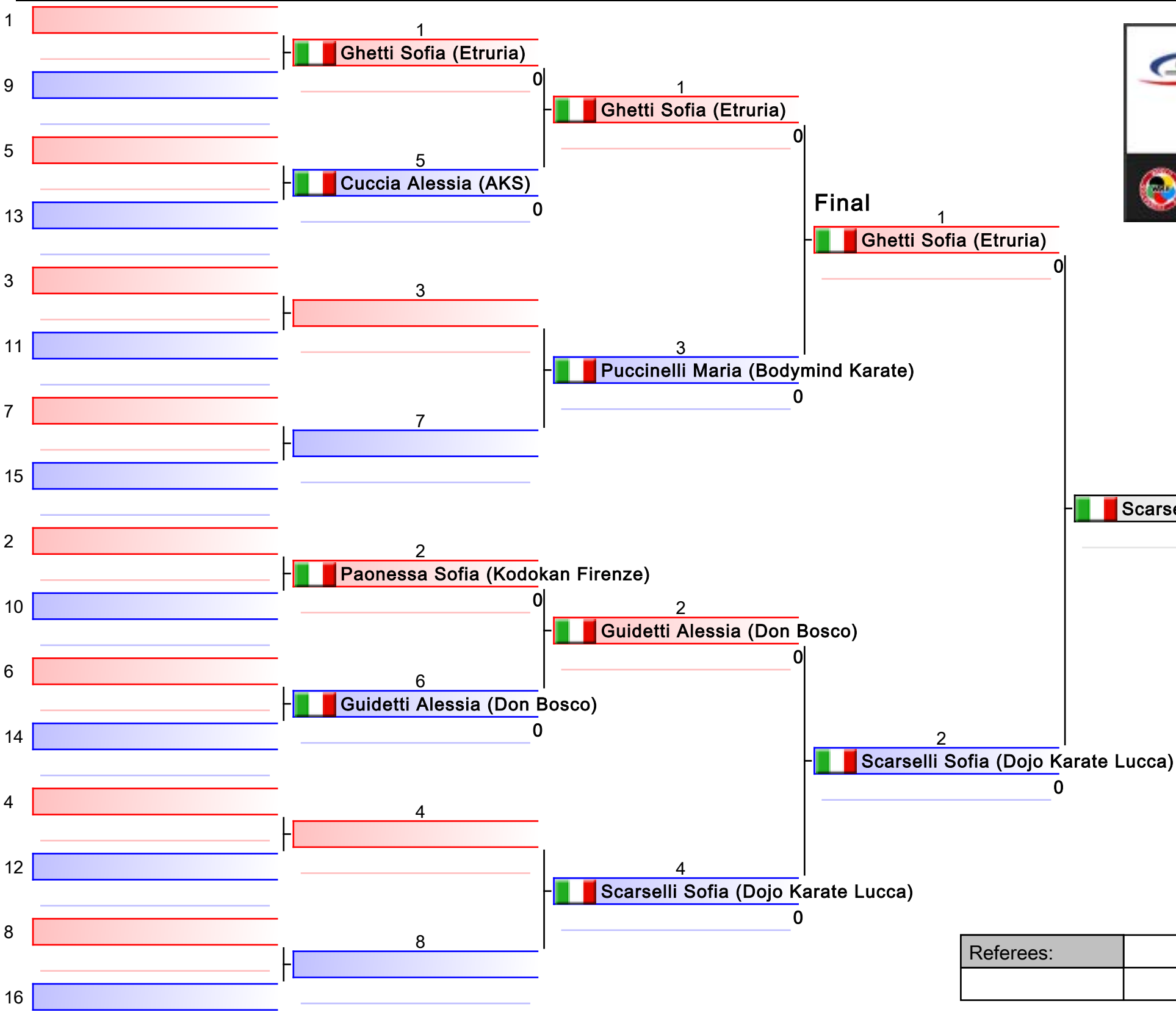

1. Scarselli Sofia (Dojo Karate Lucca)
2. Gheti Sofia (Etruria)
3. Guidetti Alessia (Don Bosco)
3. Cuccia Alessia (AKS)
5. Puccinelli Maria (Bodymind Karate)

Referees:			

B - Kumite F Es.A 53 Kg
Trofeo Toscana Primavera

Tatami
3

Pool
1/1

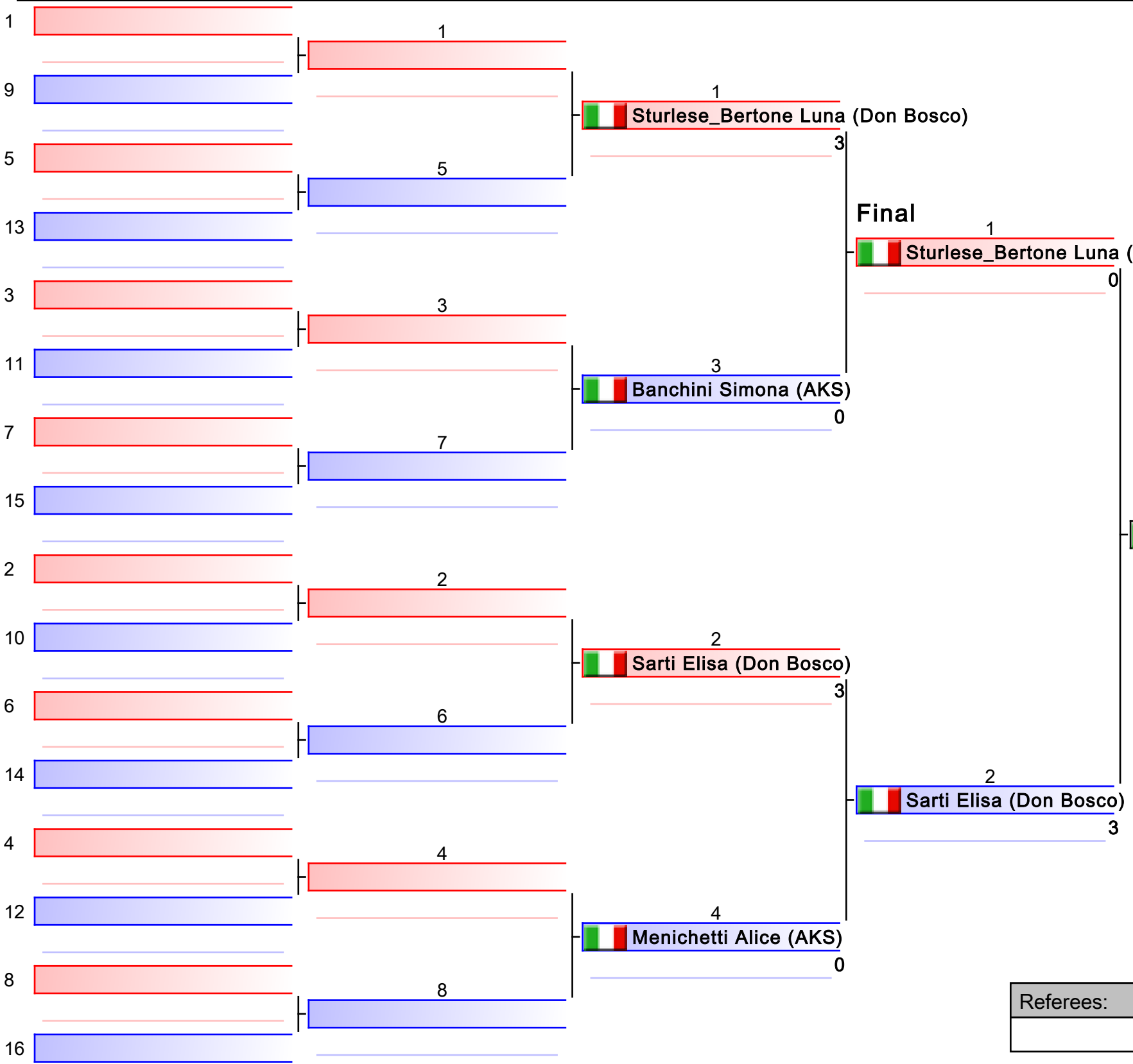

Final

Sarti Elisa (Don Bosco)

1. Sarti Elisa (Don Bosco)
2. Sturlese Bertone Luna (Don Bosco)
3. Banchini Simona (AKS)
3. Menichetti Alice (AKS)

Referees:			

B - Kumite F Es.A 68 Kg - Round Robin (each against each)

Trofeo Toscana Primavera

Tatami
4

Pool
1/1

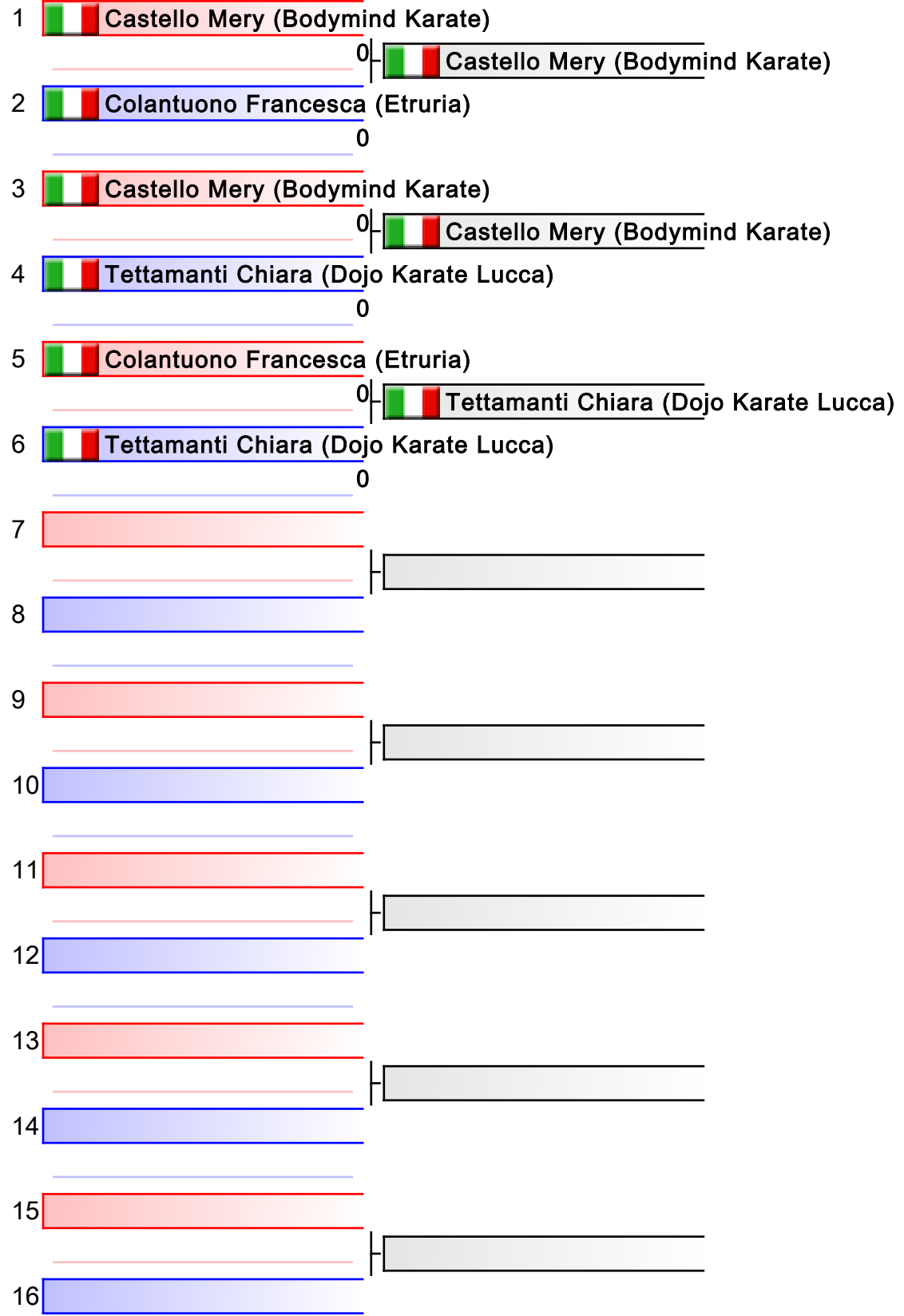

1. Castello Mery (Bodymind Karate)
2. Tettamanti Chiara (Dojo Karate Lucca)
3. Colantuono Francesca (Etruria)

Referees:			

B - Kumite F Es.B 63 Kg

Trofeo Toscana Primavera

Tatami
3

Pool
1/1

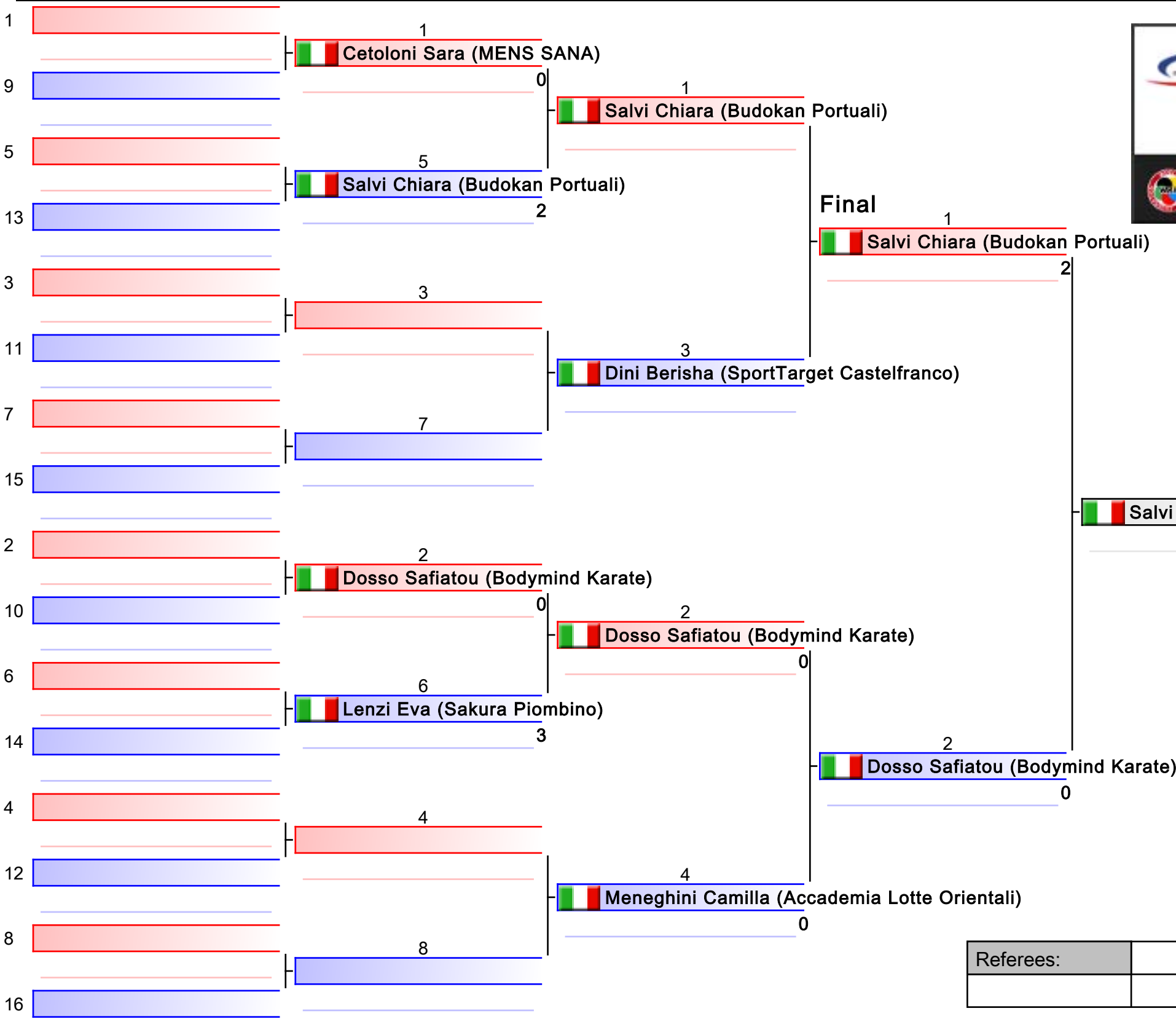

1. Salvi Chiara (Budokan Portuali)
2. Dosso Safiatou (Bodymind Karate)
3. Cetoloni Sara (MENS SANA)
3. Lenzi Eva (Sakura Piombino)
5. Dini Berisha (SportTarget Castelfranco)
5. Meneghini Camilla (Accademia Lotte Orientali)

Referees:			

B - Kumite F Es.a 42 Kg
Trofeo Toscana Primavera

Tatami
4

Pool
1/1

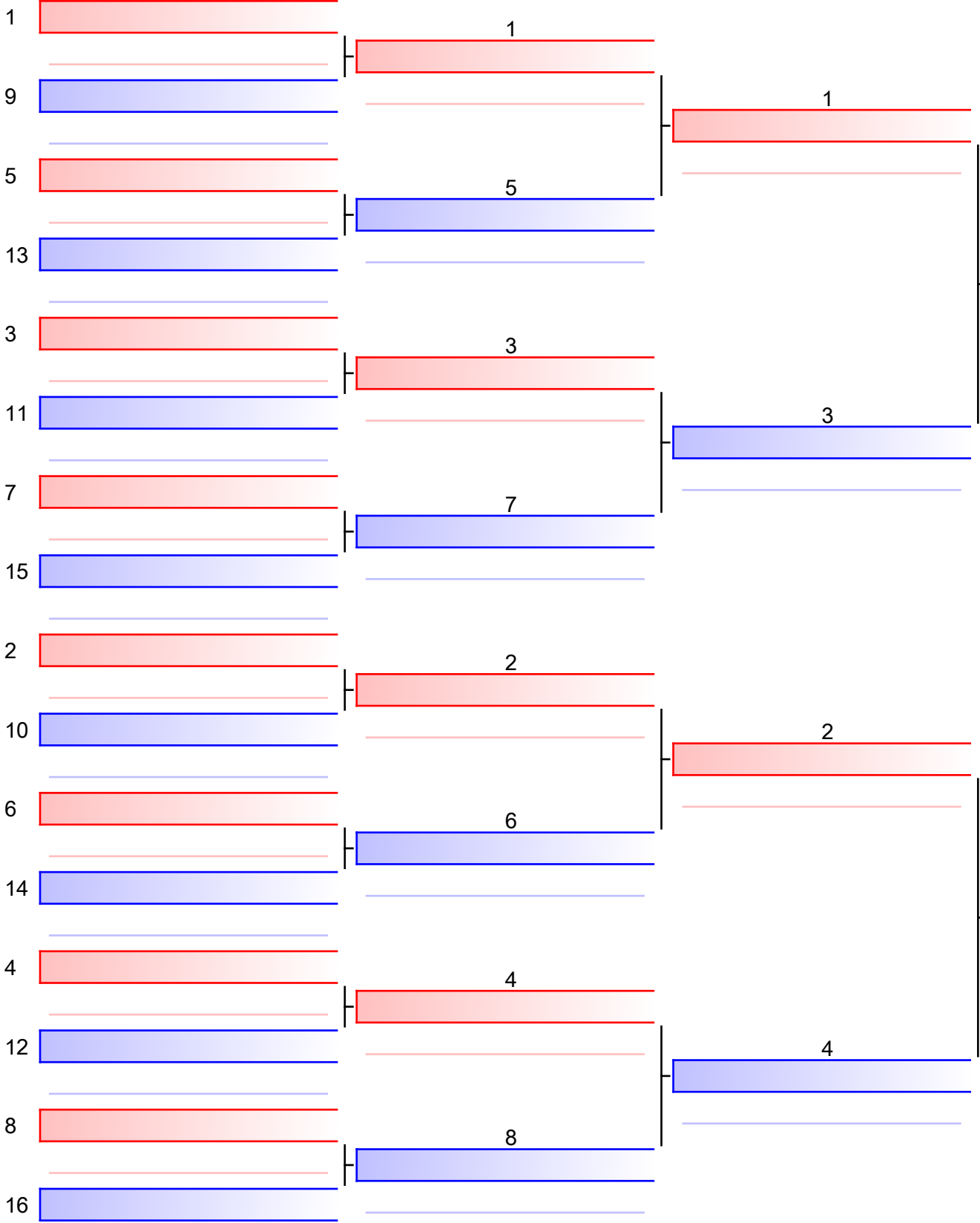

Final

Baldi Elena (Budokan Montelupo)

0

Baldi Elena (Budokan Montelupo)

Spagnesi Bianca (MENS SANA)

0

1. Baldi Elena (Budokan Montelupo)
2. Spagnesi Bianca (MENS SANA)

Referees:			

B - Kumite F Jun 55 kg
Trofeo Toscana Primavera

Tatami Pool
1/1

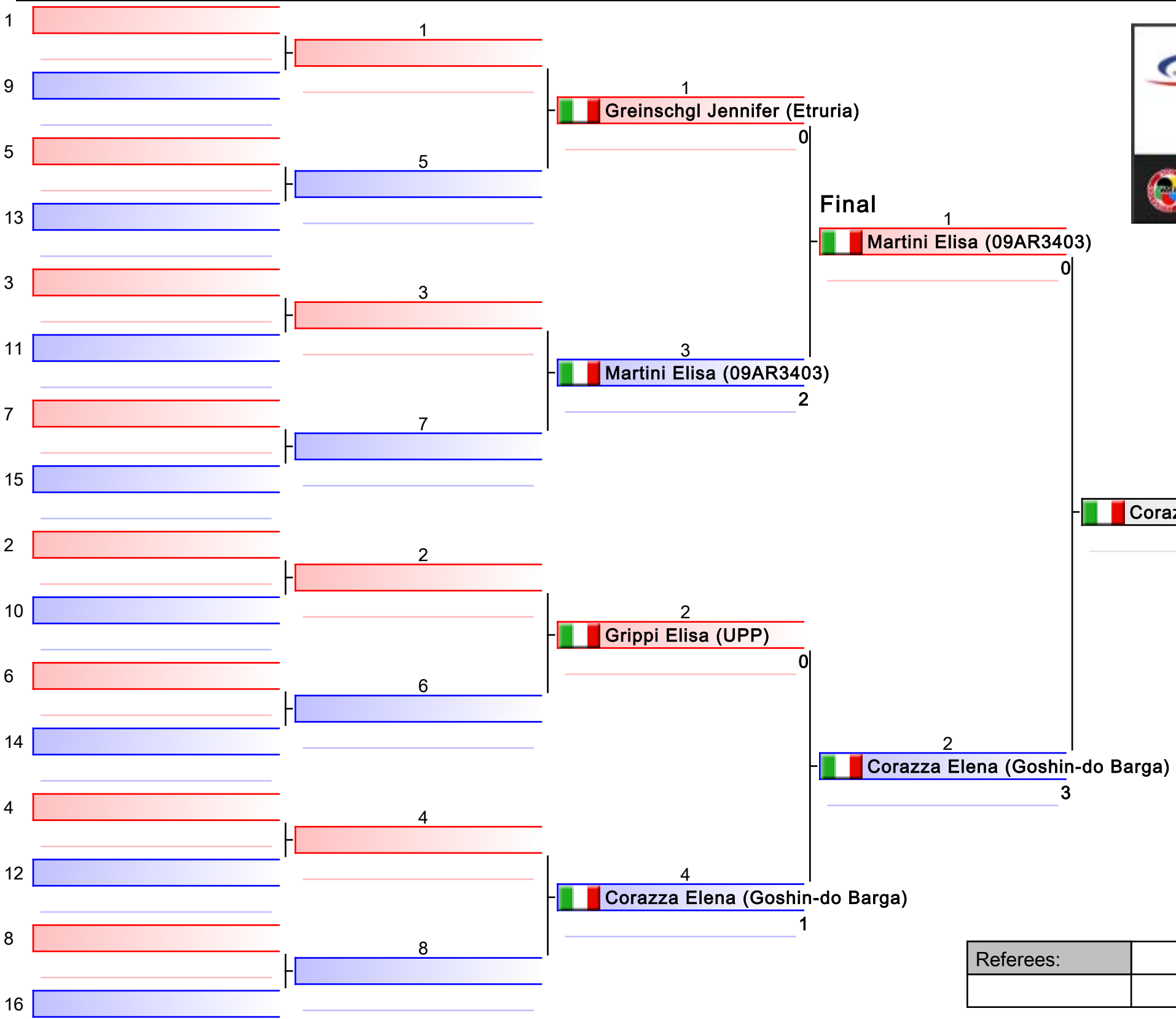

1. Corazza Elena (Goshin-do Barga)
2. Martini Elisa (09AR3403)
3. Greinschgl Jennifer (Etruria)
3. Grippi Elisa (UPP)

Referees:			

B - Kumite F Sen 55 Kg - Round Robin (each against each)

Trofeo Toscana Primavera

Tatami
4

Pool
1/1

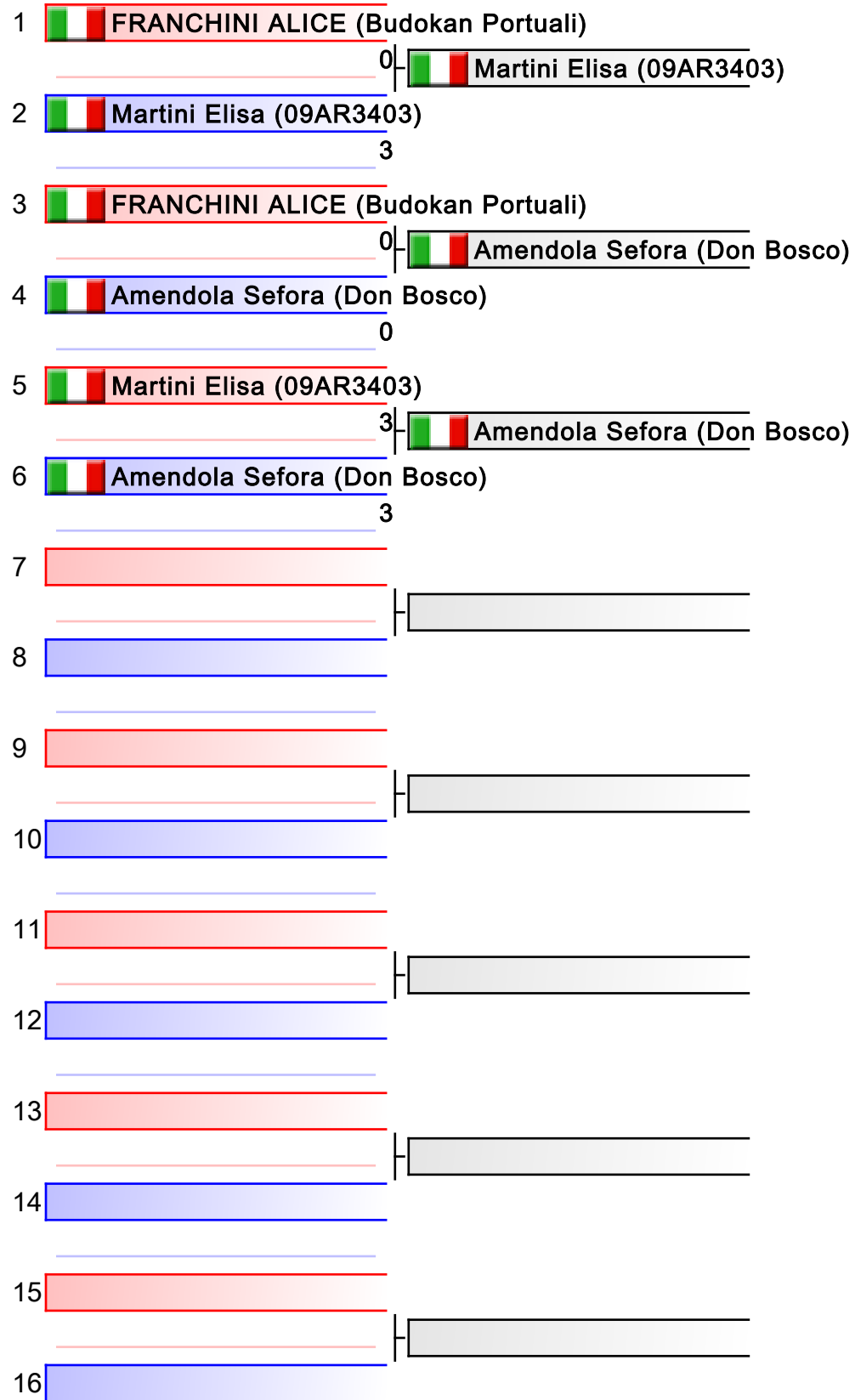

1. Amendola Sefora (Don Bosco)
2. Martini Elisa (09AR3403)
3. FRANCHINI ALICE (Budokan Portuali)

Referees:			

B - Kumite M Cad 61 Kg
Trofeo Toscana Primavera

Tatami
4

Pool
1/1

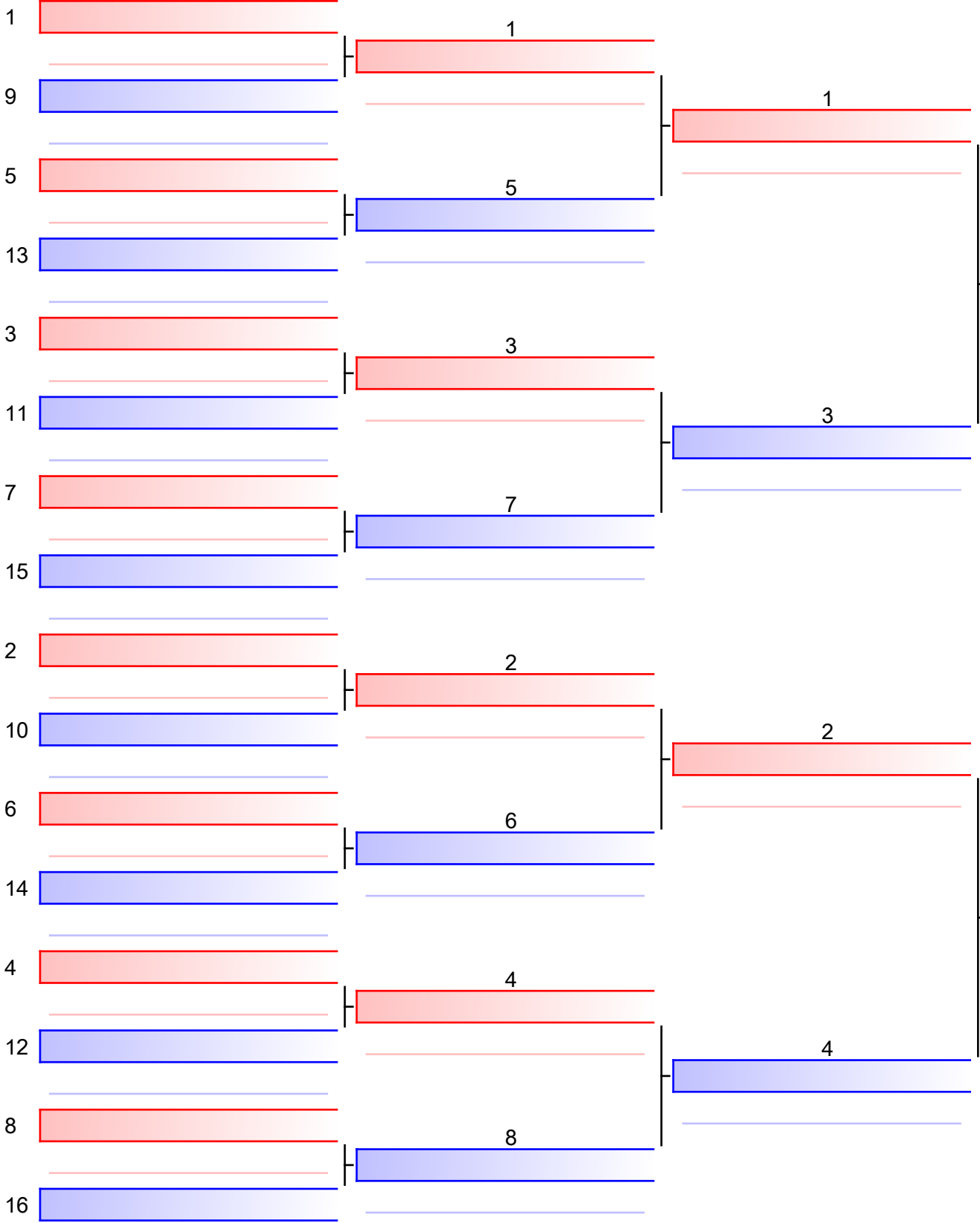

Final

Cucco Federico (SKF)

1

Cucco Federico (SKF)

Ceccherelli Andrea (09PI2178)

0

1. Cucco Federico (SKF)
2. Ceccherelli Andrea (09PI2178)

Referees:			

B - Kumite M Cad 68 Kg
Trofeo Toscana Primavera

Tatami
4

Pool
1/1

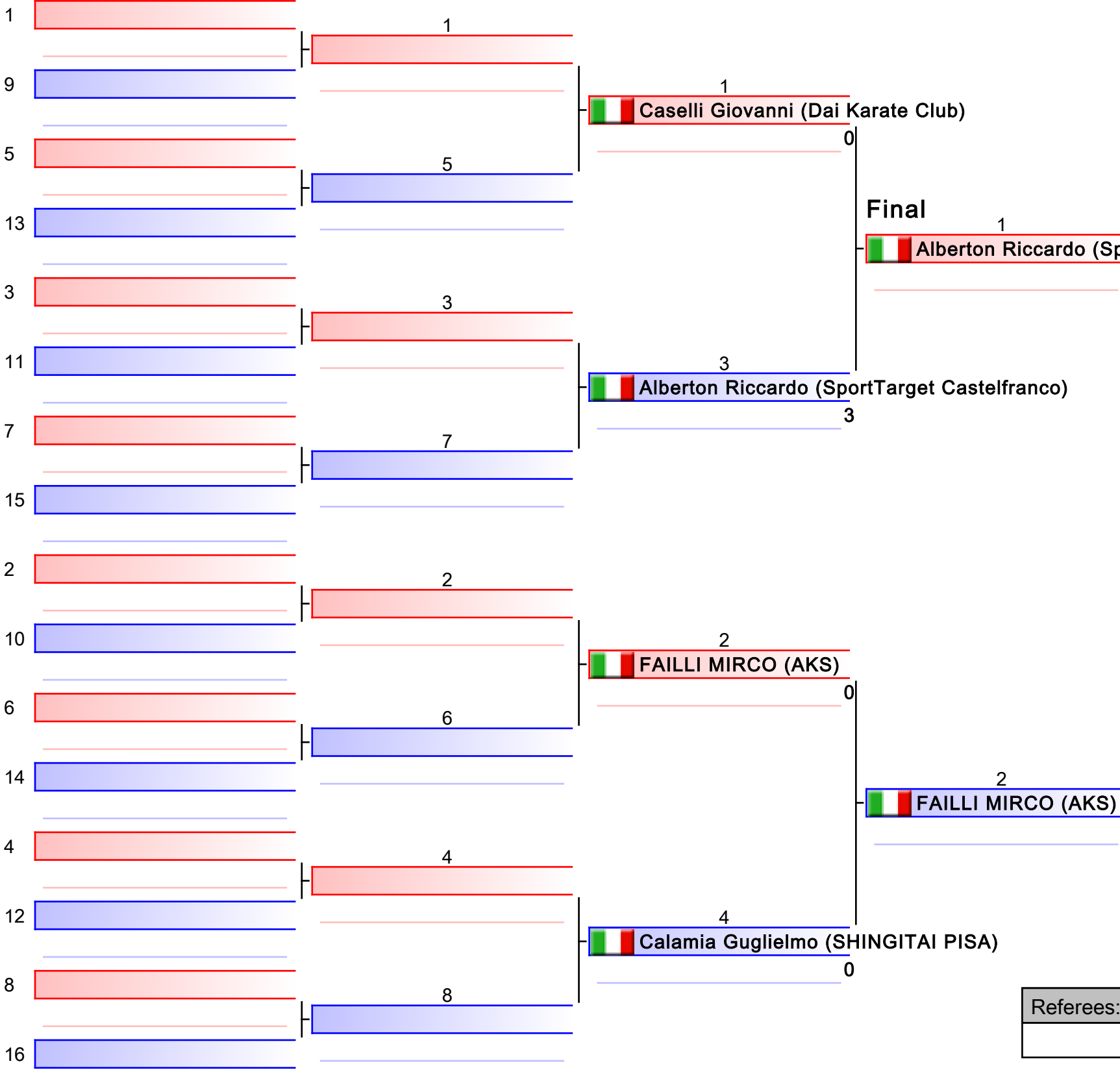

Final

1. Alberton Riccardo (SportTarget Castelfranco)
2. FAILLI MIRCO (AKS)
3. Caselli Giovanni (Dai Karate Club)
3. Calamia Guglielmo (SHINGITAI PISA)

Referees:			

B - Kumite M Cad 76+ kg - Round Robin (each against each)

Trofeo Toscana Primavera

Tatami
3

Pool
1/1

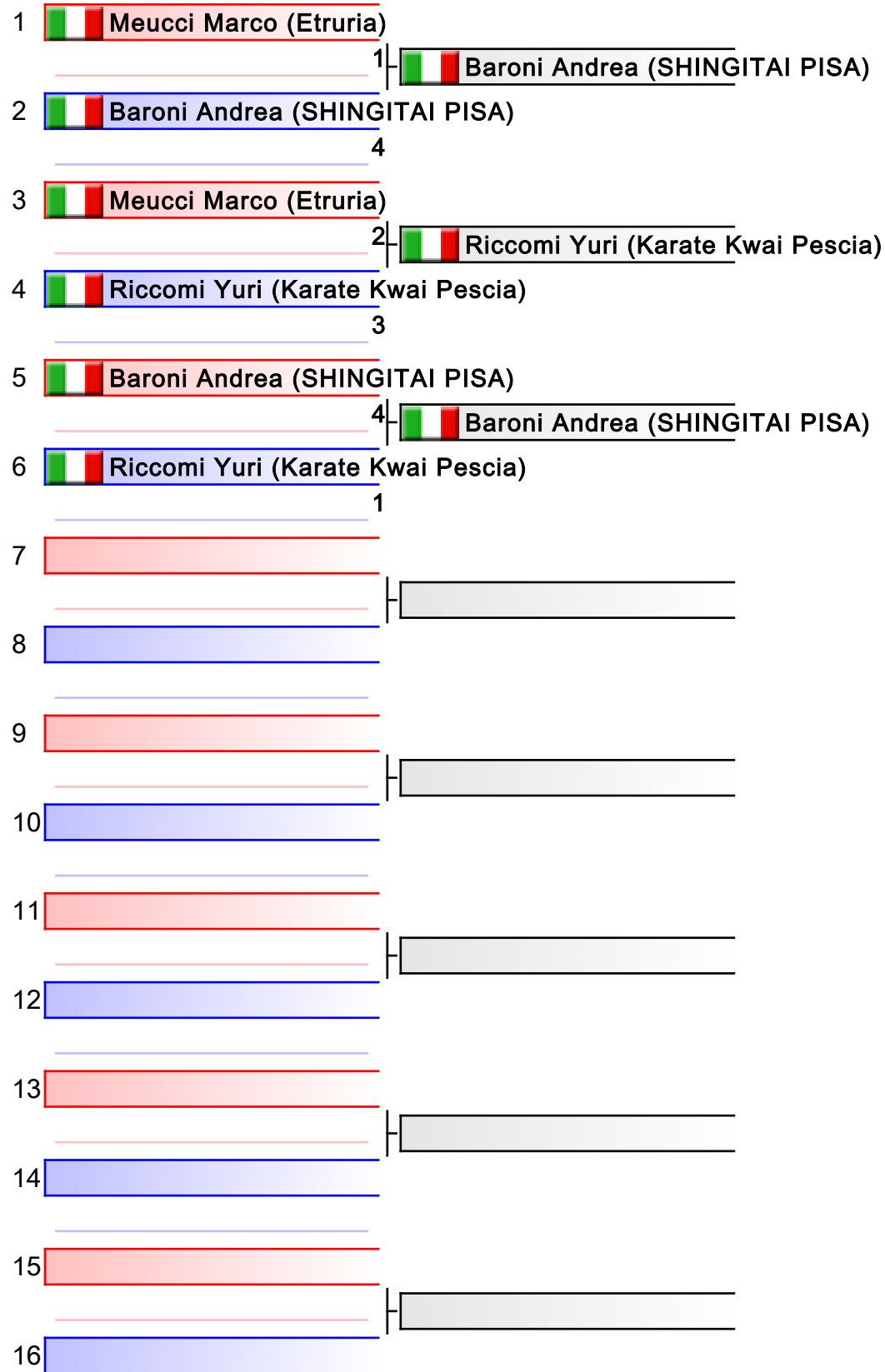

1. Baroni Andrea (SHINGITAI PISA)
2. Riccomi Yuri (Karate Kwai Pesca)
3. Meucci Marco (Etruria)

Referees:			

B - Kumite M Es.A 35-40 Kg

Trofeo Toscana Primavera

Tatami
1

Pool
1/1

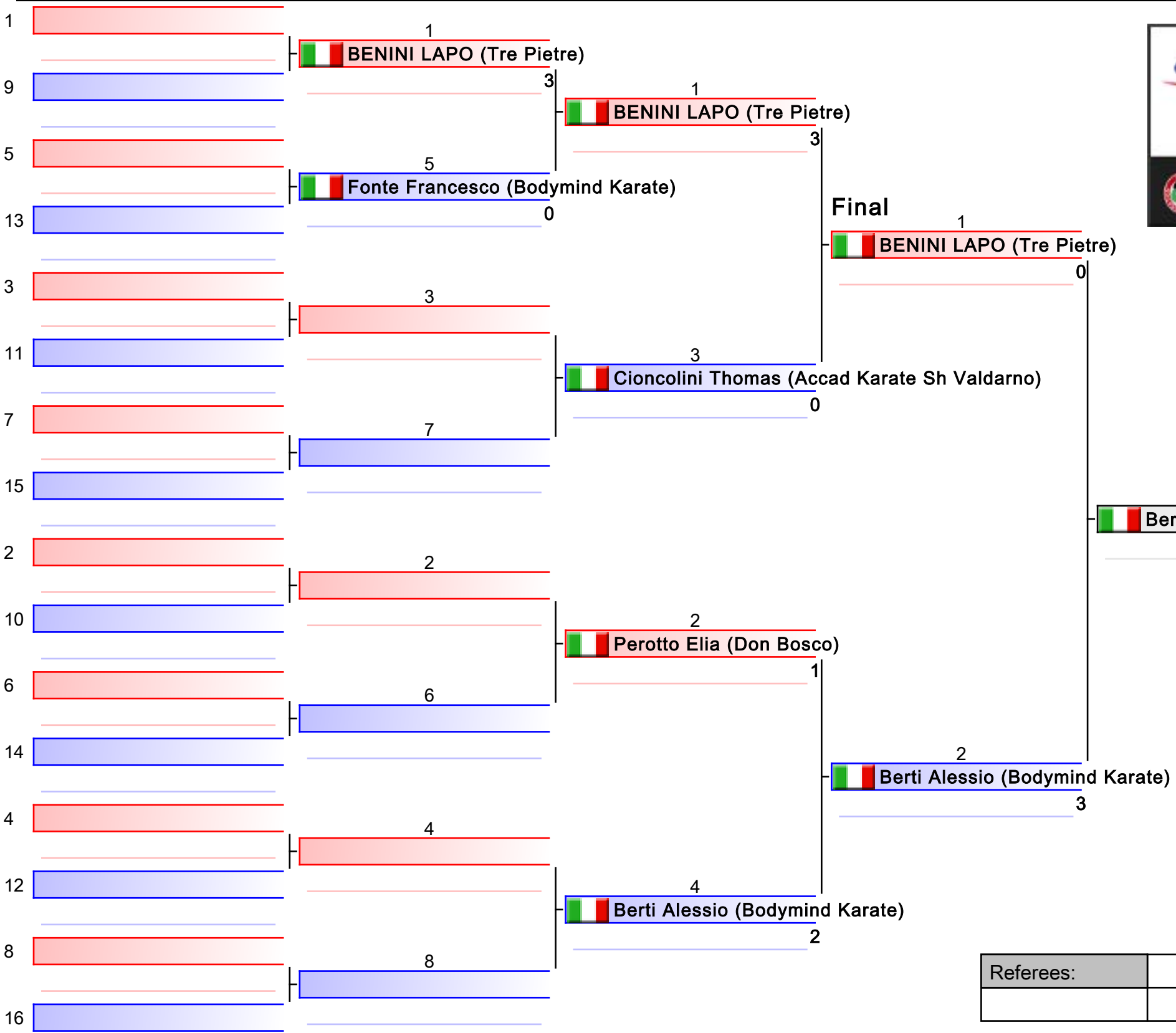

1. Berti Alessio (Bodymind Karate)
2. BENINI LAPO (Tre Pietre)
3. Perotto Elia (Don Bosco)
3. Cioncolini Thomas (Accad Karate Sh Valdarno)
5. Fonte Francesco (Bodymind Karate)

Referees:			

B - Kumite M Es.A 45 kg
Trofeo Toscana Primavera

Tatami
1

Pool
1/1

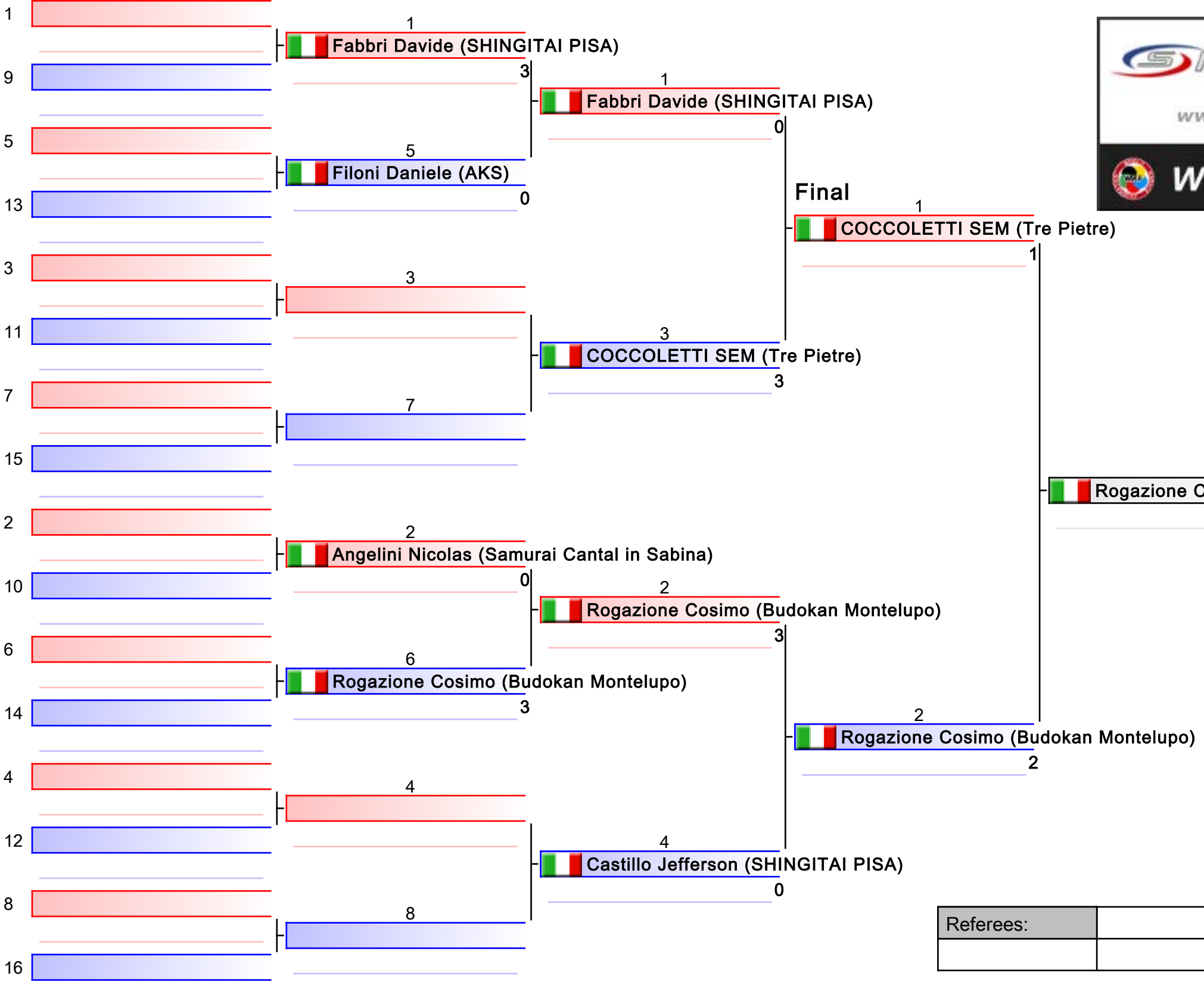

1. Rogazione Cosimo (Budokan Montelupo)
2. COCCOLETTI SEM (Tre Pietre)
3. Fabbri Davide (SHINGITAI PISA)
3. Castillo Jefferson (SHINGITAI PISA)
5. Angelini Nicolas (Samurai Cantal in Sabina)

Referees:			

B - Kumite M Es.A 50 Kg
Trofeo Toscana Primavera

Tatami
2

Pool
1/1

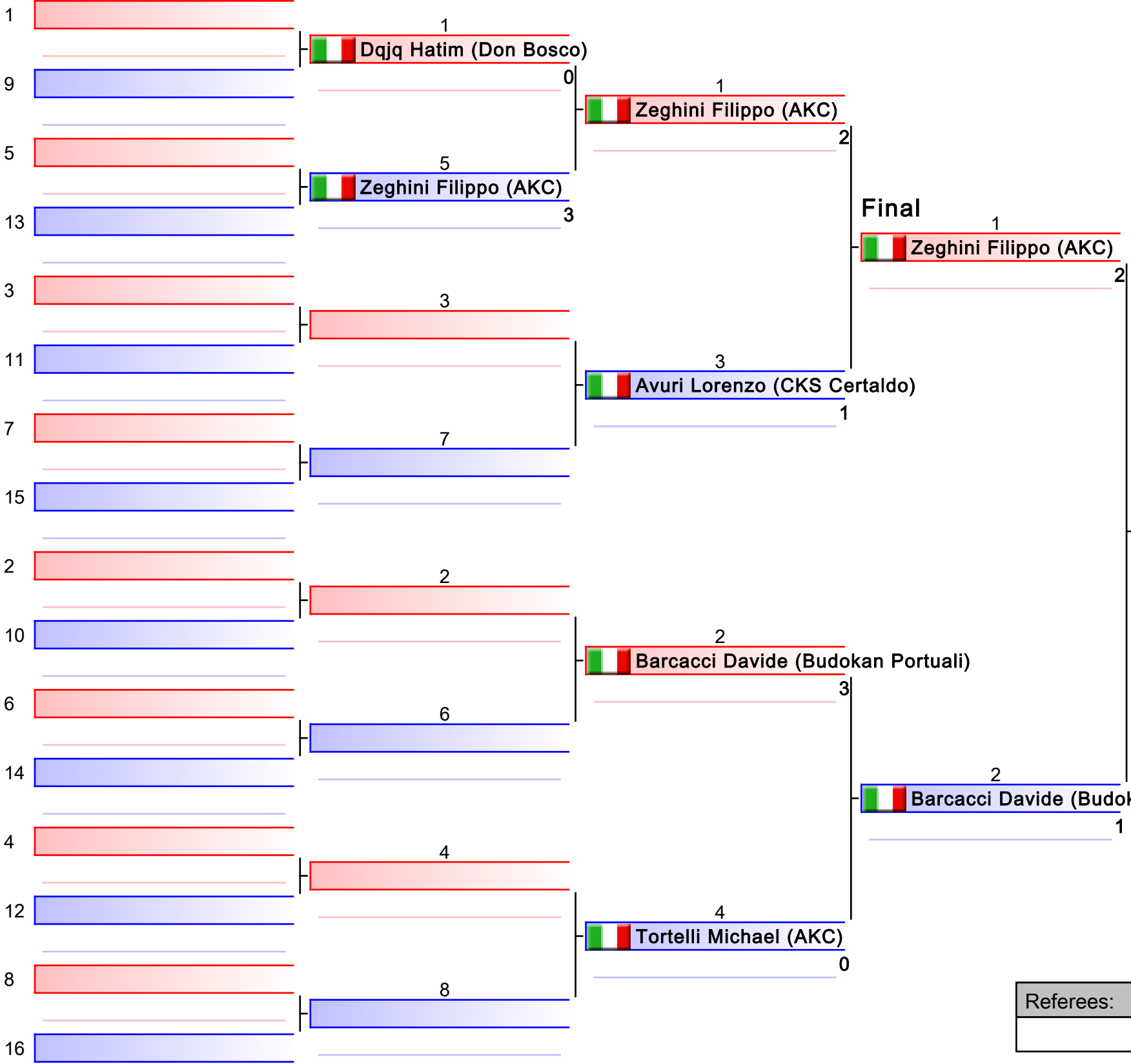

1. Zeghini Filippo (AKC)
2. Barcacci Davide (Budokan Portuali)
3. Tortelli Michael (AKC)
3. Dqjq Hatim (Don Bosco)
5. Avuri Lorenzo (CKS Certaldo)

Referees:			

B - Kumite M Es.A 55 Kg - Round Robin (each against each)

Trofeo Toscana Primavera

Tatami
2

Pool
1/1

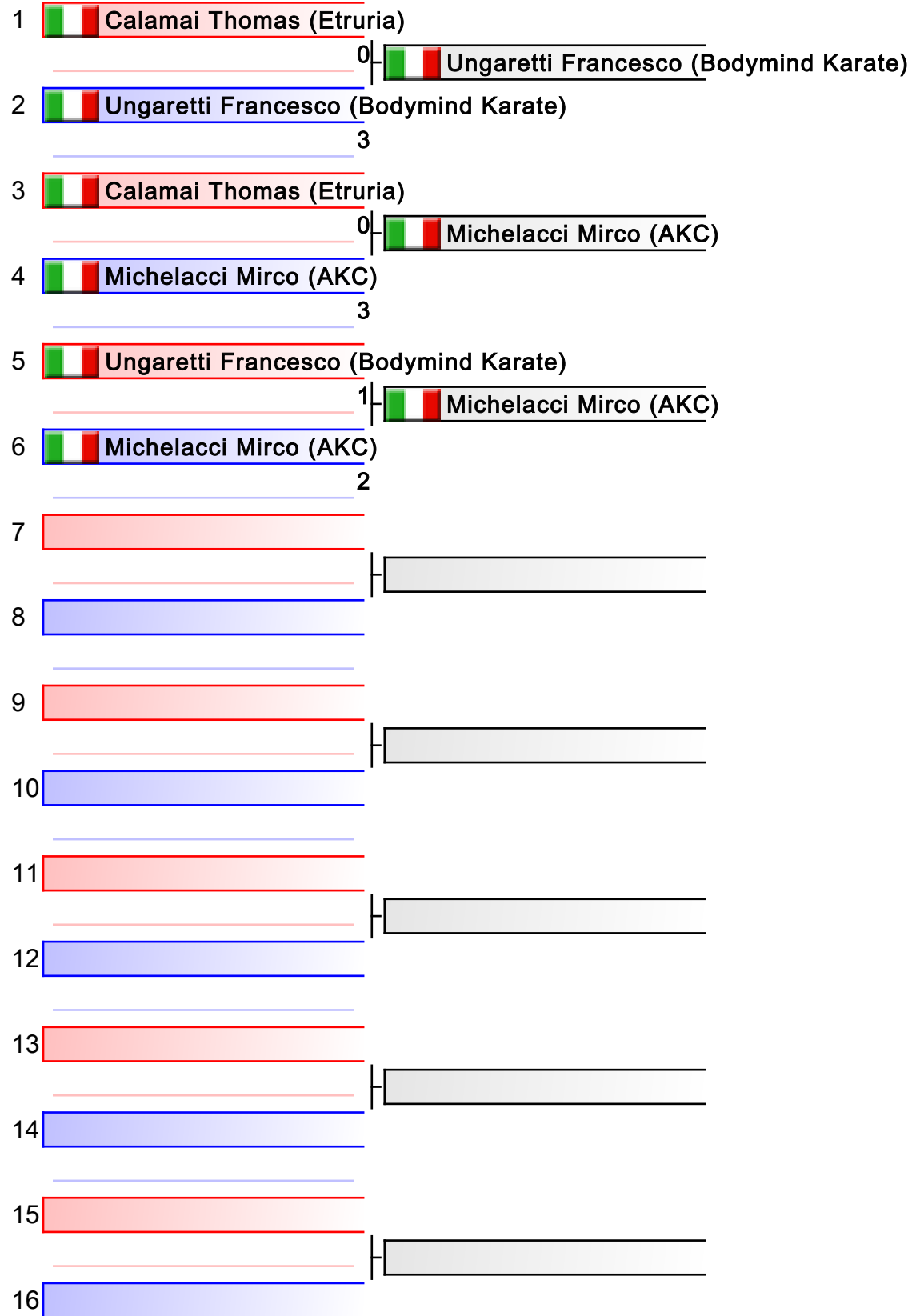

1. Michelacci Mirco (AKC)
2. Ungaretti Francesco (Bodymind Karate)
3. Calamai Thomas (Etruria)

Referees:			

B - Kumite M Es.A 61 Kg
Trofeo Toscana Primavera

Tatami **2**
Pool **1/1**

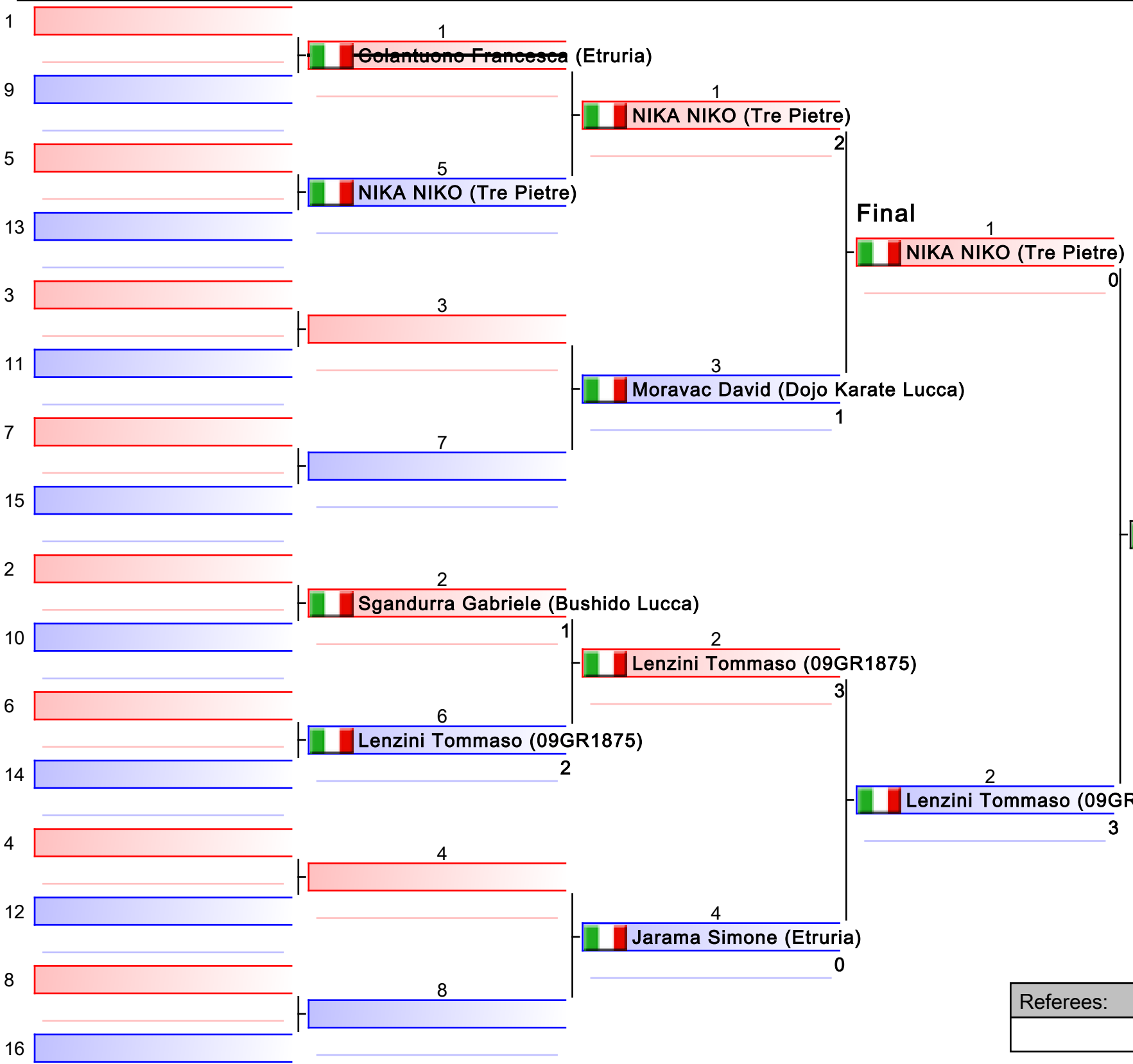

1. Lenzini Tommaso (09GR1875)
2. NIK A NIKO (Tre Pietre)
3. Moravac David (Dojo Karate Lucca)
3. Sgandurra Gabriele (Bushido Lucca)
5. Jarama Simone (Etruria)

Referees:			

B - Kumite M Es.B 42-47 Kg
Trofeo Toscana Primavera

Tatami
1

Pool
1/1

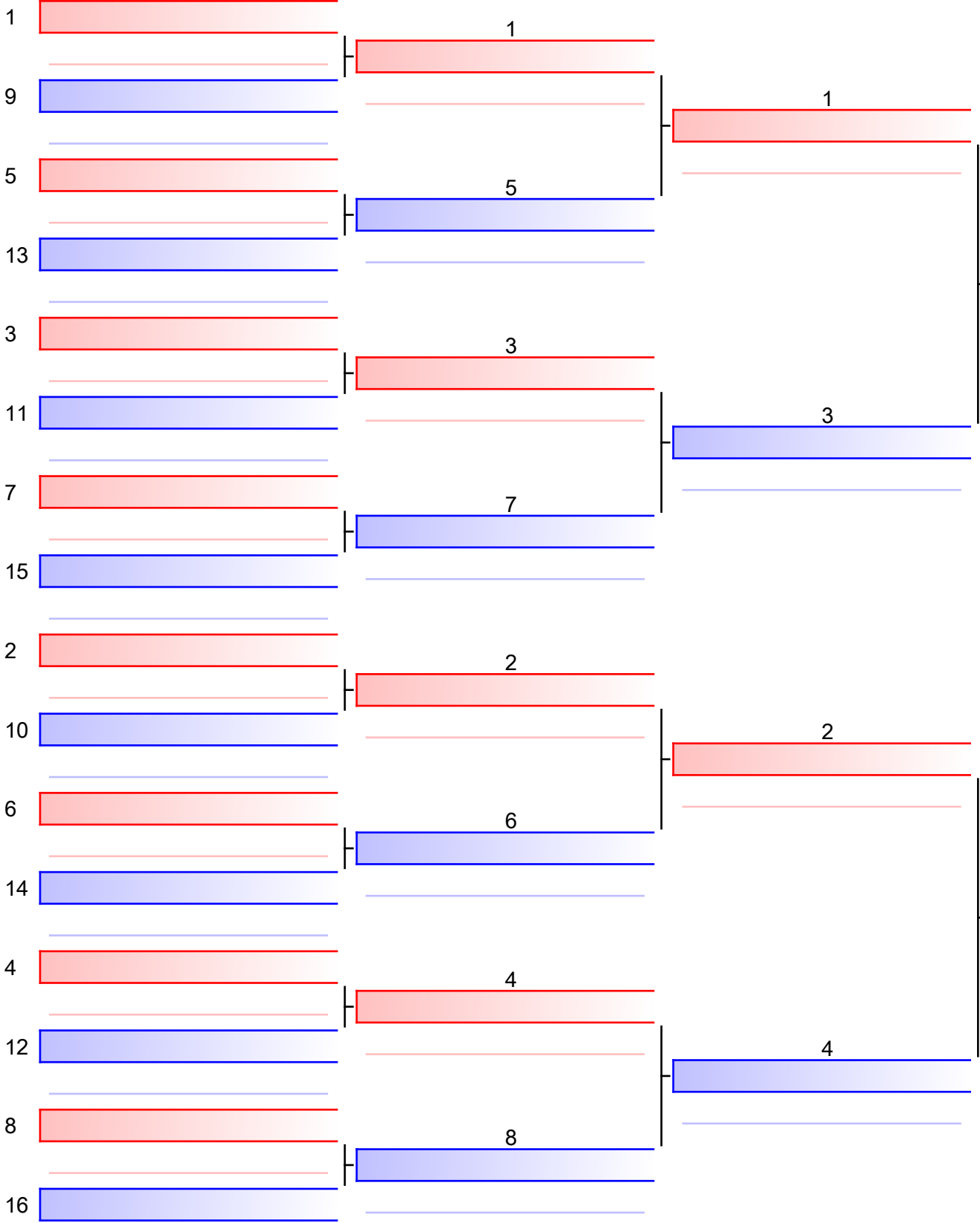

Final

Gentili Giacomo (Karate Kwai Pescia)

1
3

Gentili Giacomo (Karate Kwai Pescia)

Pescini Alberto (Budokan Montelupo)

2
0

1. Gentili Giacomo (Karate Kwai Pescia)
2. Pescini Alberto (Budokan Montelupo)

Referees:			

B - Kumite M Es.B 52 Kg - Round Robin (each against each)

Trofeo Toscana Primavera

Tatami
1

Pool
1/1

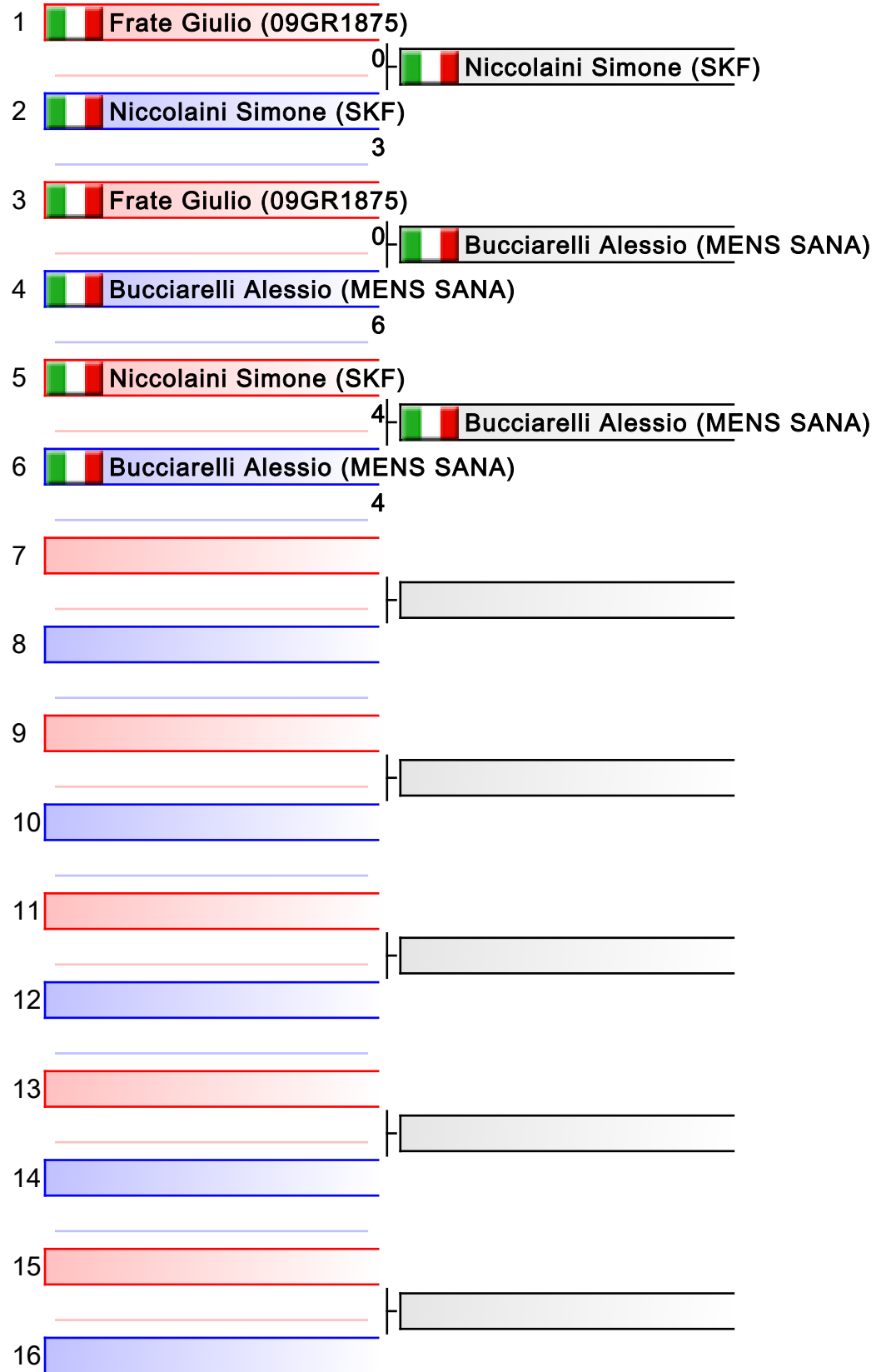

1. Bucciarelli Alessio (MENS SANA)
2. Niccolaini Simone (SKF)
3. Frate Giulio (09GR1875)

Referees:			

B - Kumite M Es.B 57 Kg - Round Robin (each against each)

Trofeo Toscana Primavera

Tatami
1

Pool
1/1

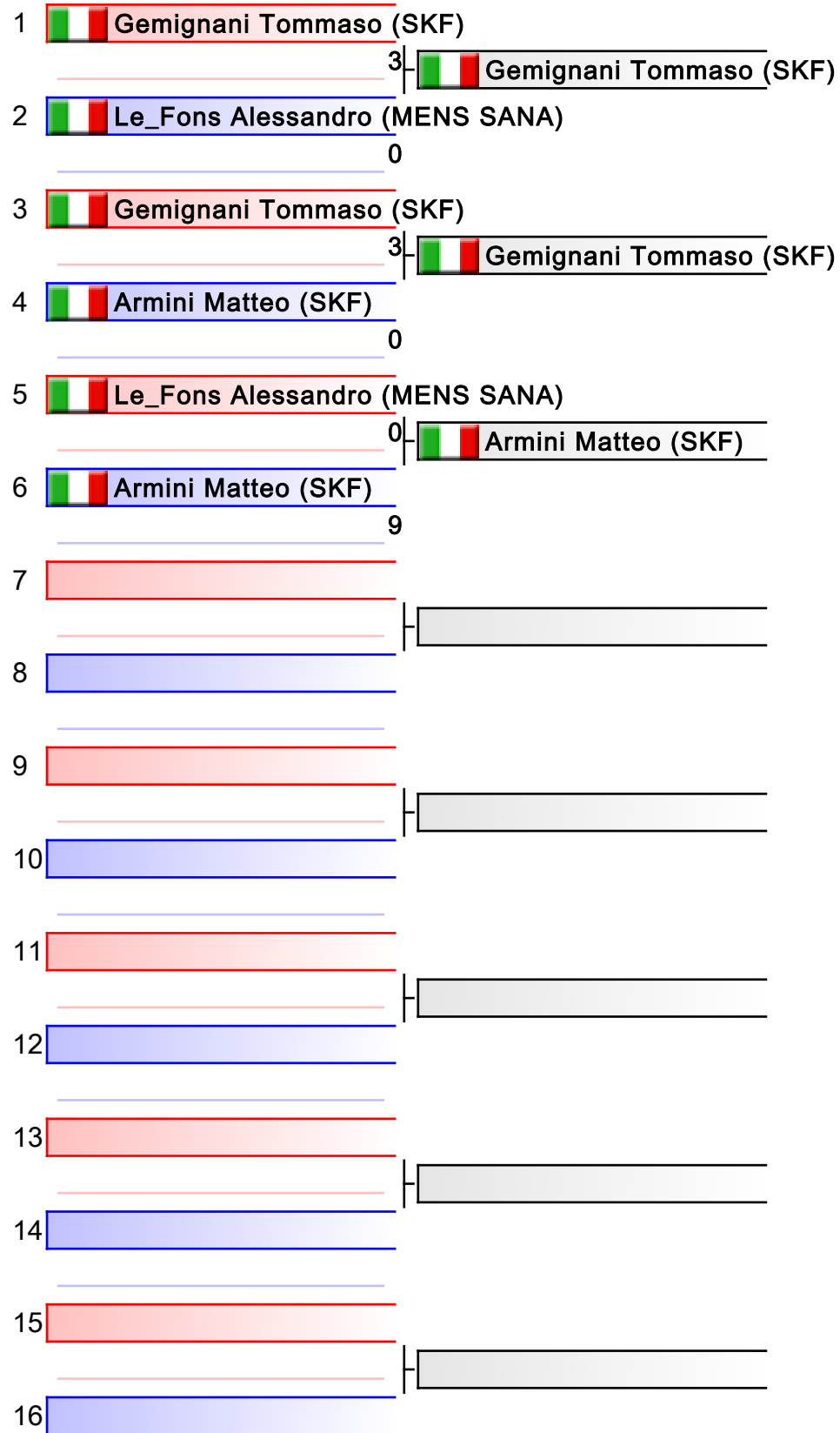

1. Gemignani Tommaso (SKF)
2. Armini Matteo (SKF)
3. Le_Fons Alessandro (MENS SANA)

Referees:			

B - Kumite M Es.B 63 Kg

Trofeo Toscana Primavera

Tatami
2

Pool
1/1

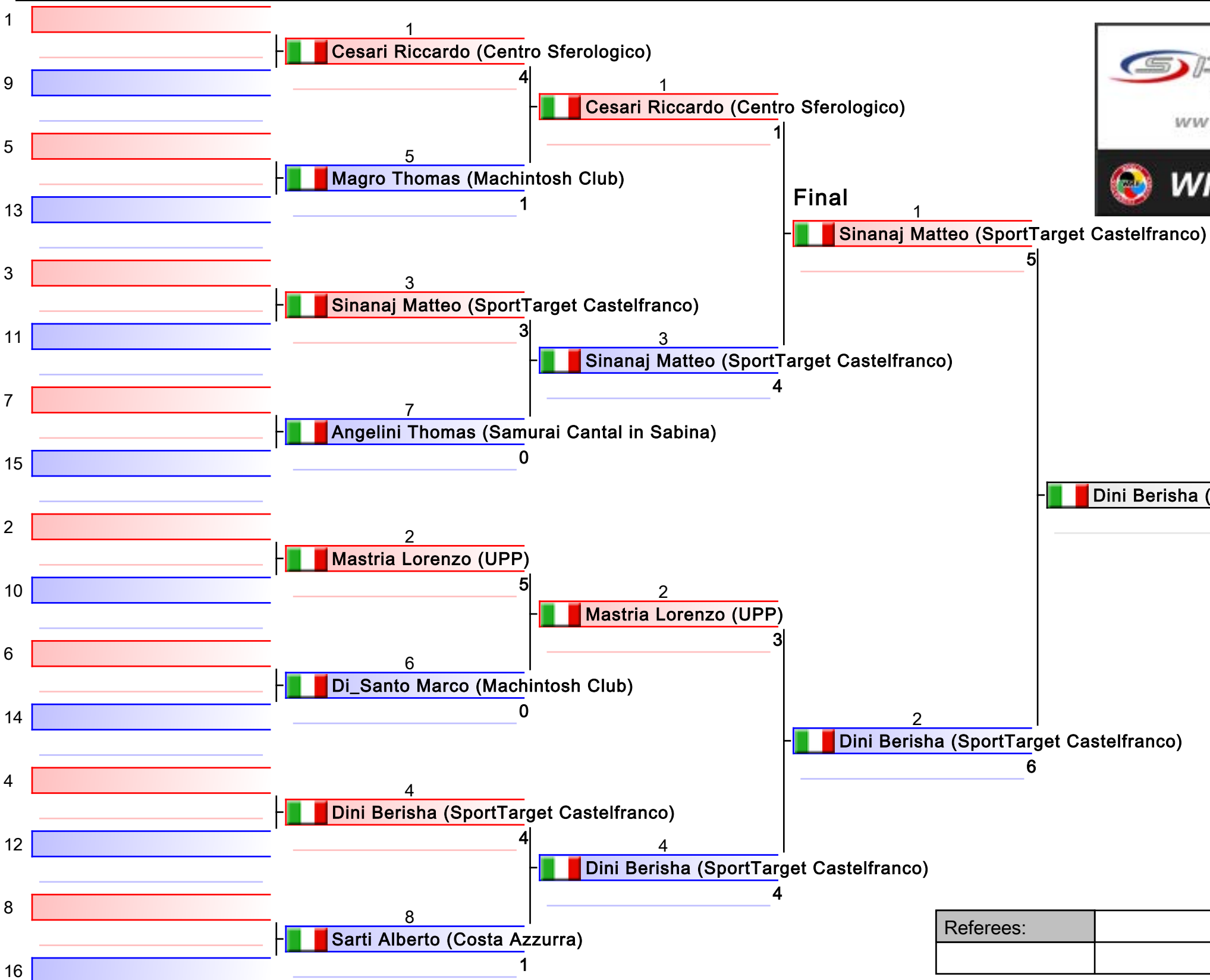

1. Dini Berisha (SportTarget Castelfranco)
2. Sinanaj Matteo (SportTarget Castelfranco)
3. Angelini Thomas (Samurai Cantal in Sabina)
3. Mastria Lorenzo (UPP)
5. Cesari Riccardo (Centro Sferologico)
5. Sarti Alberto (Costa Azzurra)

Referees:			

B - Kumite M Es.B 78 kg - Round Robin (each against each)

Trofeo Toscana Primavera

Tatami
1

Pool
1/1

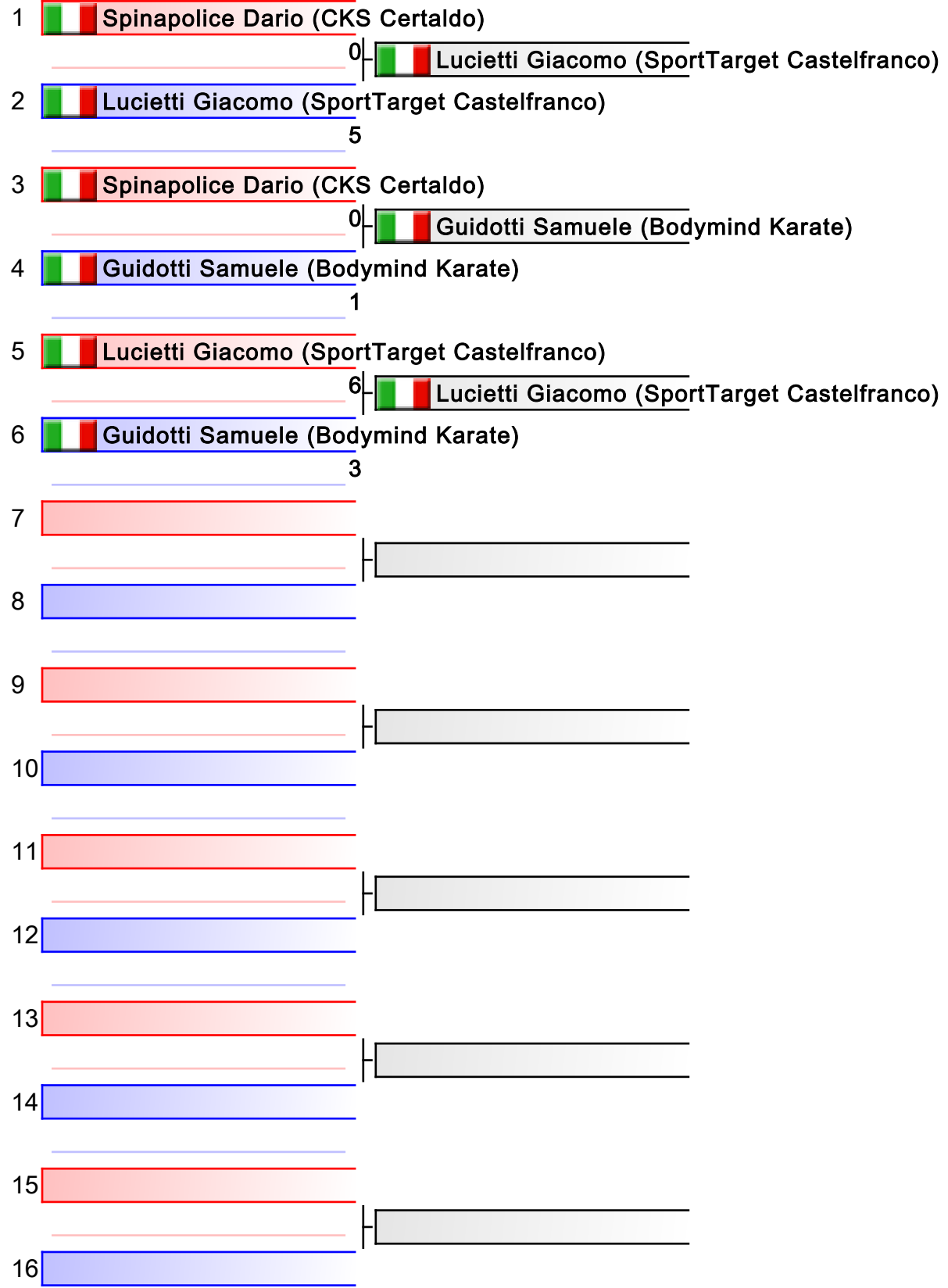

1. Lucietti Giacomo (SportTarget Castelfranco)
2. Guidotti Samuele (Bodymind Karate)
3. Spinapolice Dario (CKS Certaldo)

Referees:			

B - Kumite M Es.B 78+ Kg
Trofeo Toscana Primavera

Tatami
1
Pool
1/1

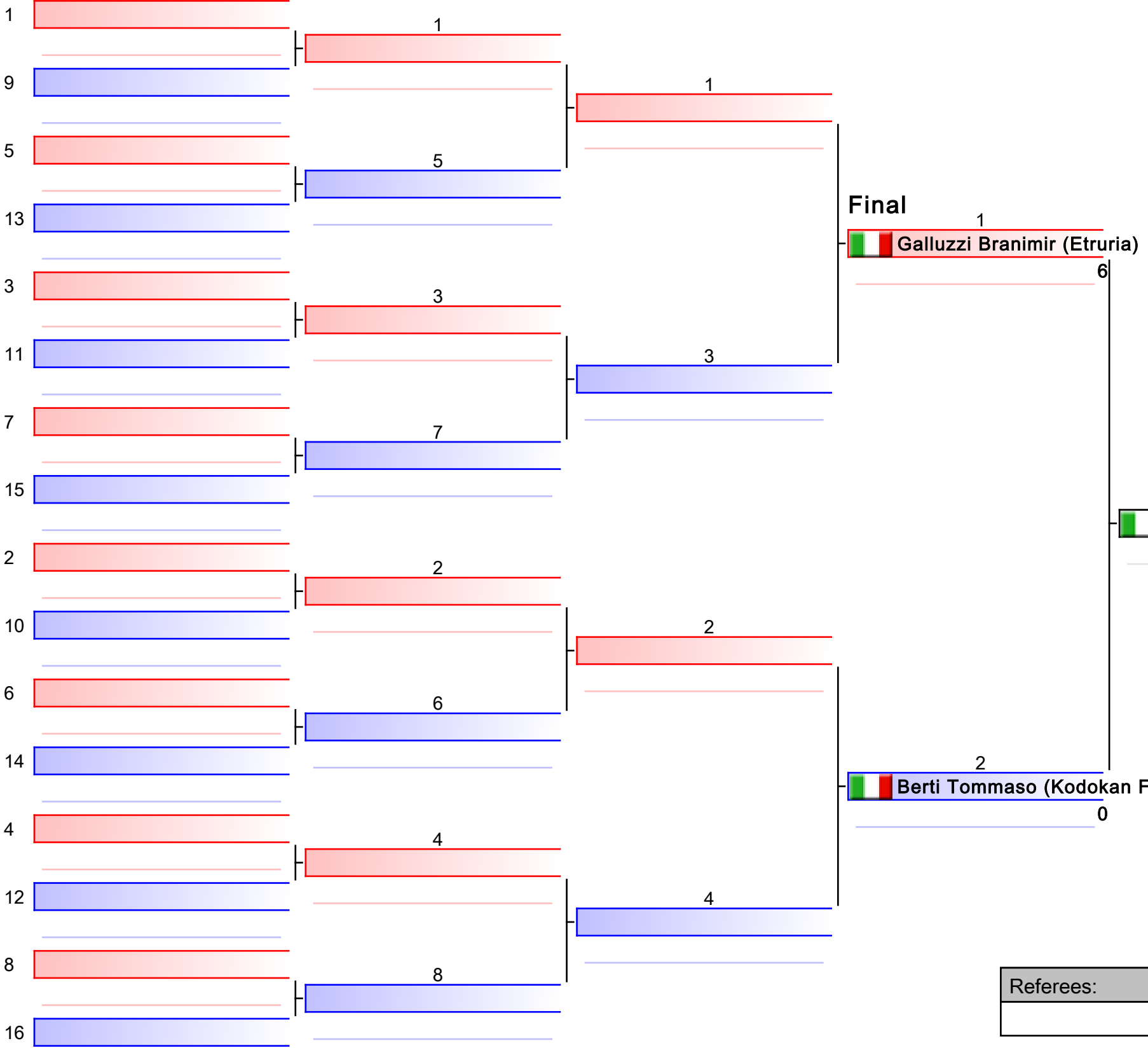

1. Galluzzi Branimir (Etruria)
2. Berti Tommaso (Kodokan Firenze)

Referees:			

B - Kumite M Jun 60 Kg - Round Robin (each against each)

Trofeo Toscana Primavera

Tatami
1

Pool
1/1

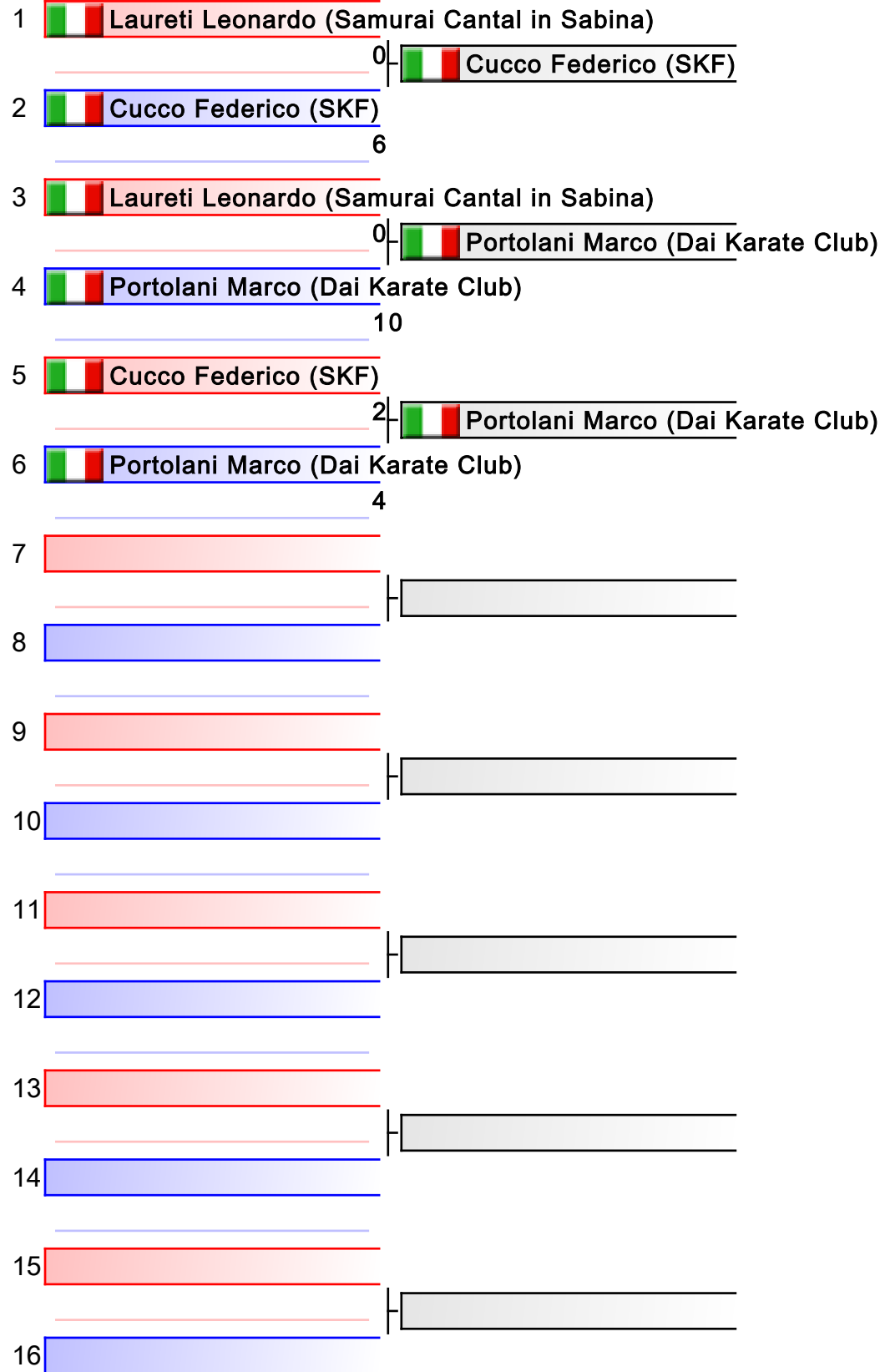

1. Portolani Marco (Dai Karate Club)
2. Cucco Federico (SKF)
3. Laureti Leonardo (Samurai Cantal in Sabina)

Referees:			

B - Kumite M Jun 67 Kg
Trofeo Toscana Primavera

Tatami
1

Pool
1/1

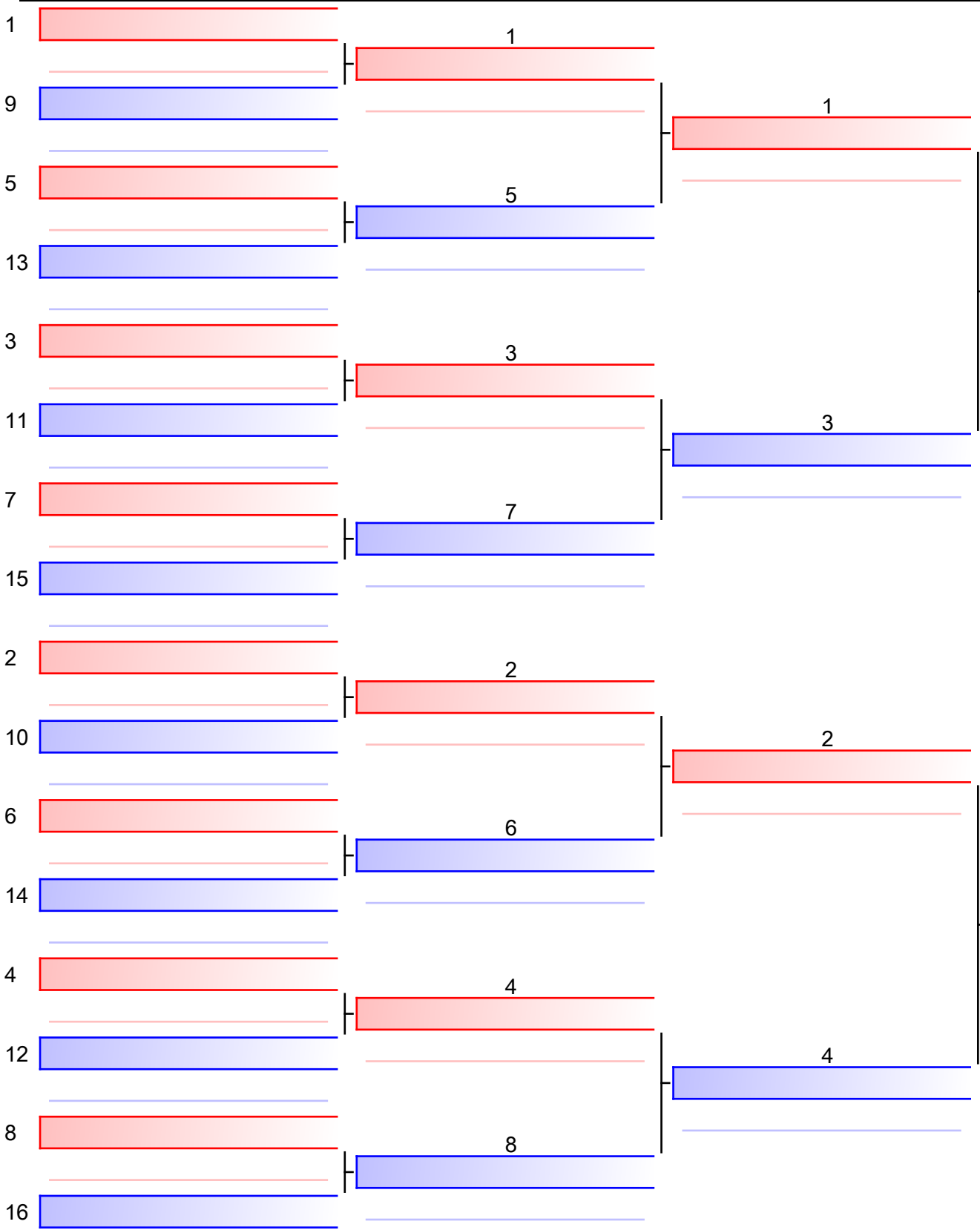

Final

Lippi Francesco (Budokan Portuali)

Lippi Francesco (Budokan Portuali)

Linari Davide (Dojo Karate Lucca)

1. Lippi Francesco (Budokan Portuali)
2. Linari Davide (Dojo Karate Lucca)

Referees:			

B - Kumite M Jun 75 Kg - Round Robin (each against each)

Trofeo Toscana Primavera

Tatami
1

Pool
1/1

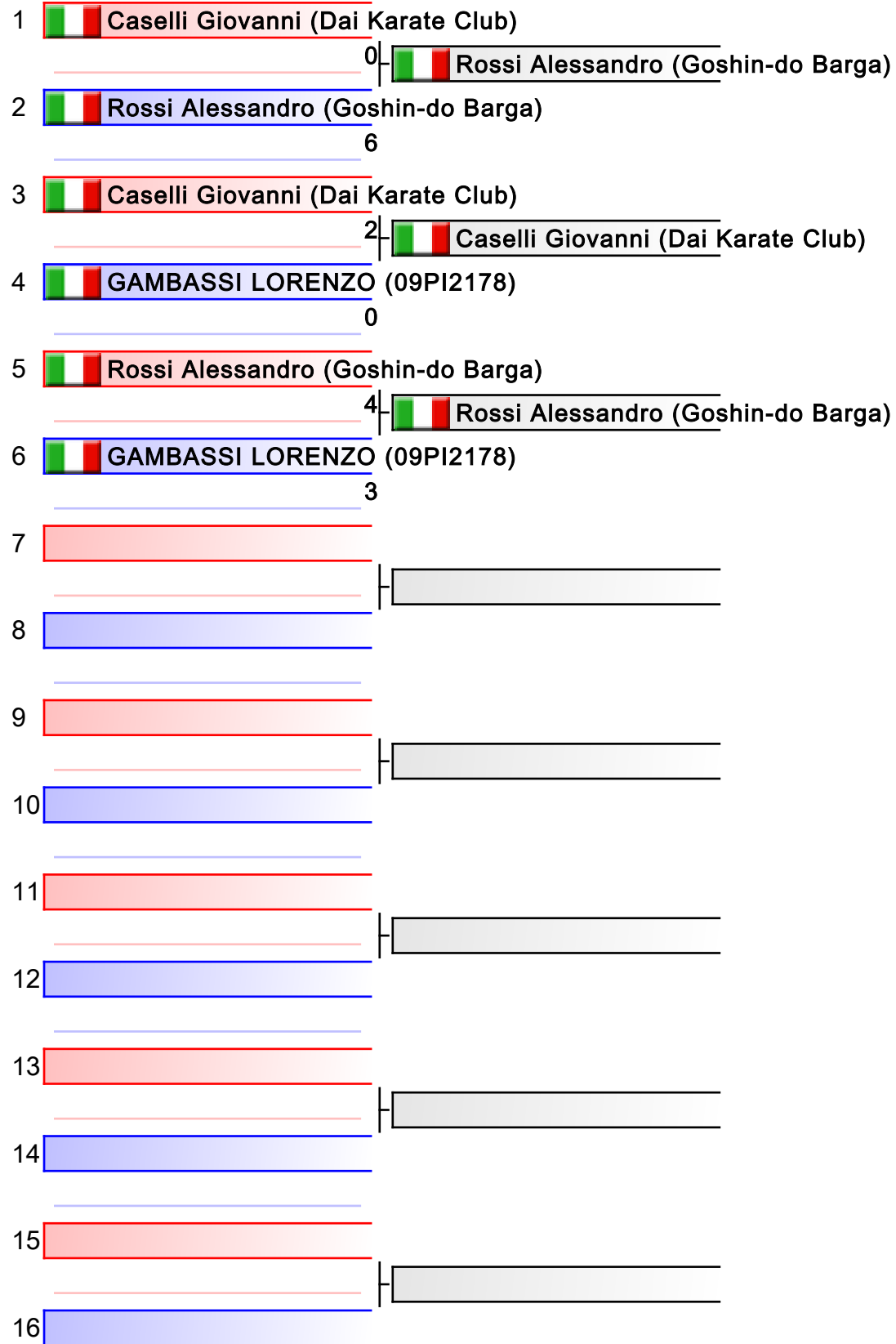

1. Rossi Alessandro (Goshin-do Barga)
2. Caselli Giovanni (Dai Karate Club)
3. GAMBASSI LORENZO (09PI2178)

Referees:			

B - Kumite M Jun 84 Kg
Trofeo Toscana Primavera

Tatami
2

Pool
1/1

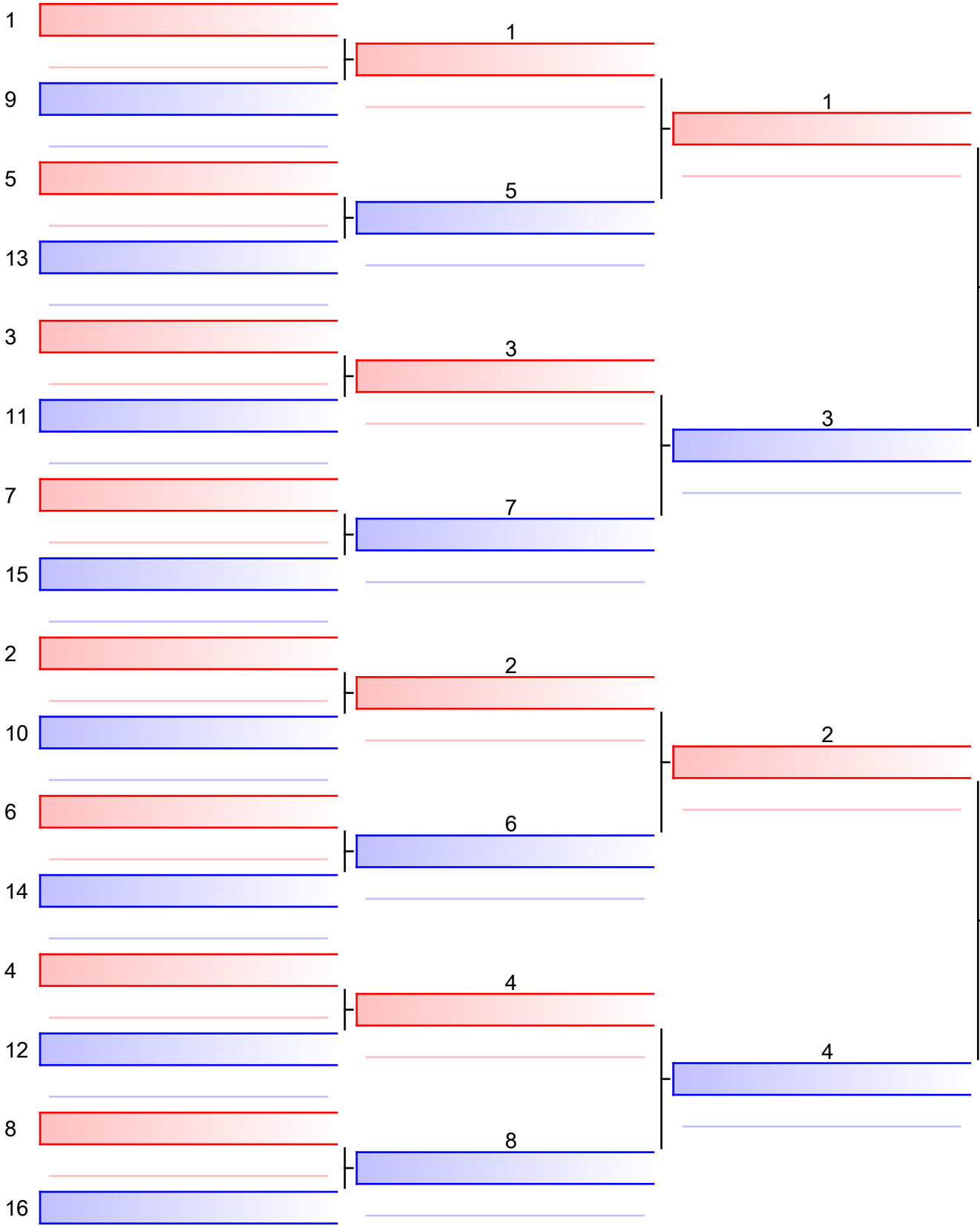

Final

1
Iannattoni Gabriele (Ronin Karate Livorno)

8

Iannattoni Gabriele (Ronin Karate Livorno)

2
Savi Lorenzo (Samurai Cantal in Sabina)

0

1. Iannattoni Gabriele (Ronin Karate Livorno)
2. Savi Lorenzo (Samurai Cantal in Sabina)

Referees:			

B - Kumite M SEN 67 Kg
Trofeo Toscana Primavera

Tatami
1

Pool
1/1

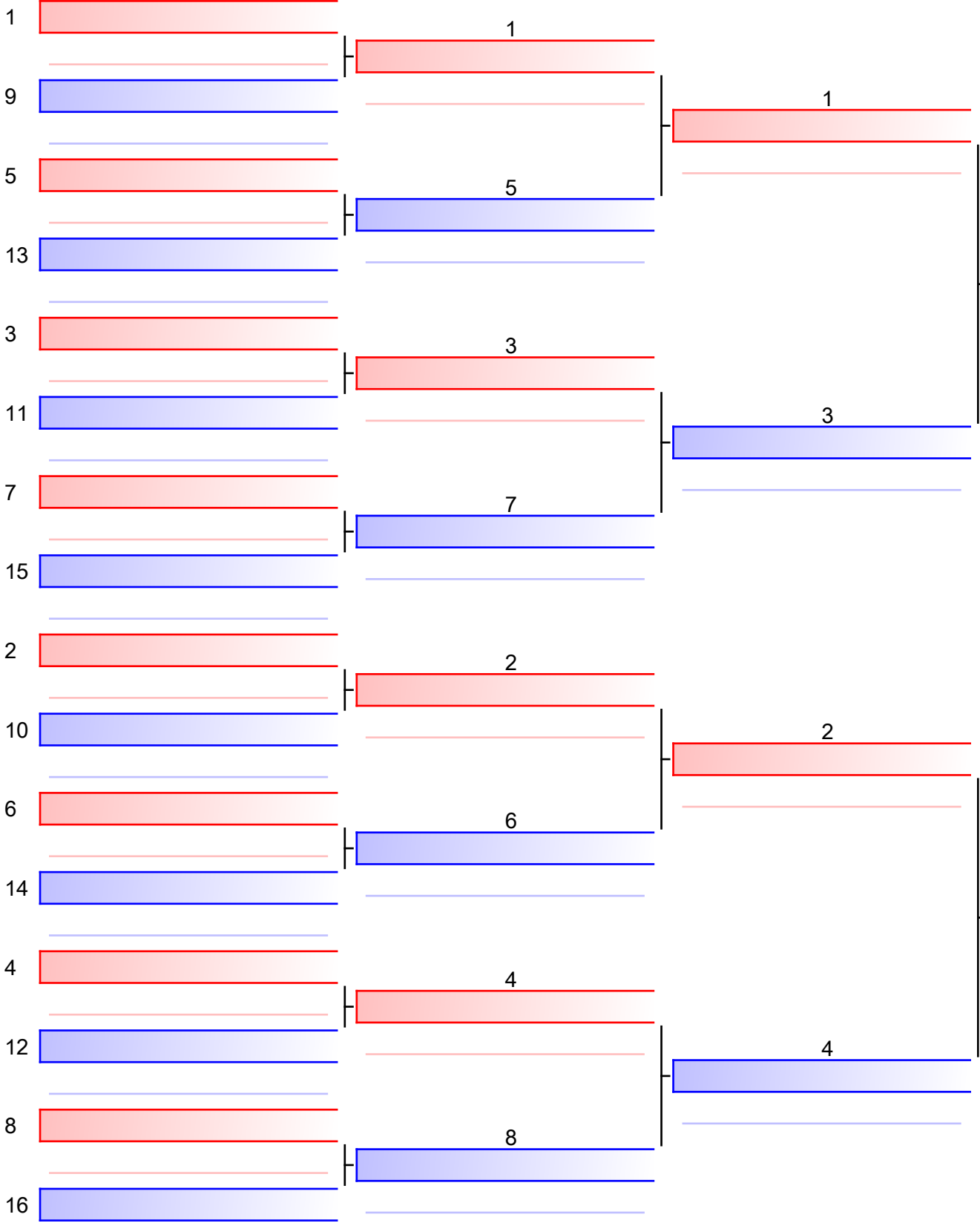

Final

Terzuoli Leonardo (MENS SANA)

6

Terzuoli Leonardo (MENS SANA)

Fabrizi Gianluca (Samurai Cantal in Sabina)

0

1. Terzuoli Leonardo (MENS SANA)
2. Fabrizi Gianluca (Samurai Cantal in Sabina)

Referees:			

B - Kumite M SEN 84 Kg - Round Robin (each against each)

Trofeo Toscana Primavera

Tatami
4

Pool
1/1

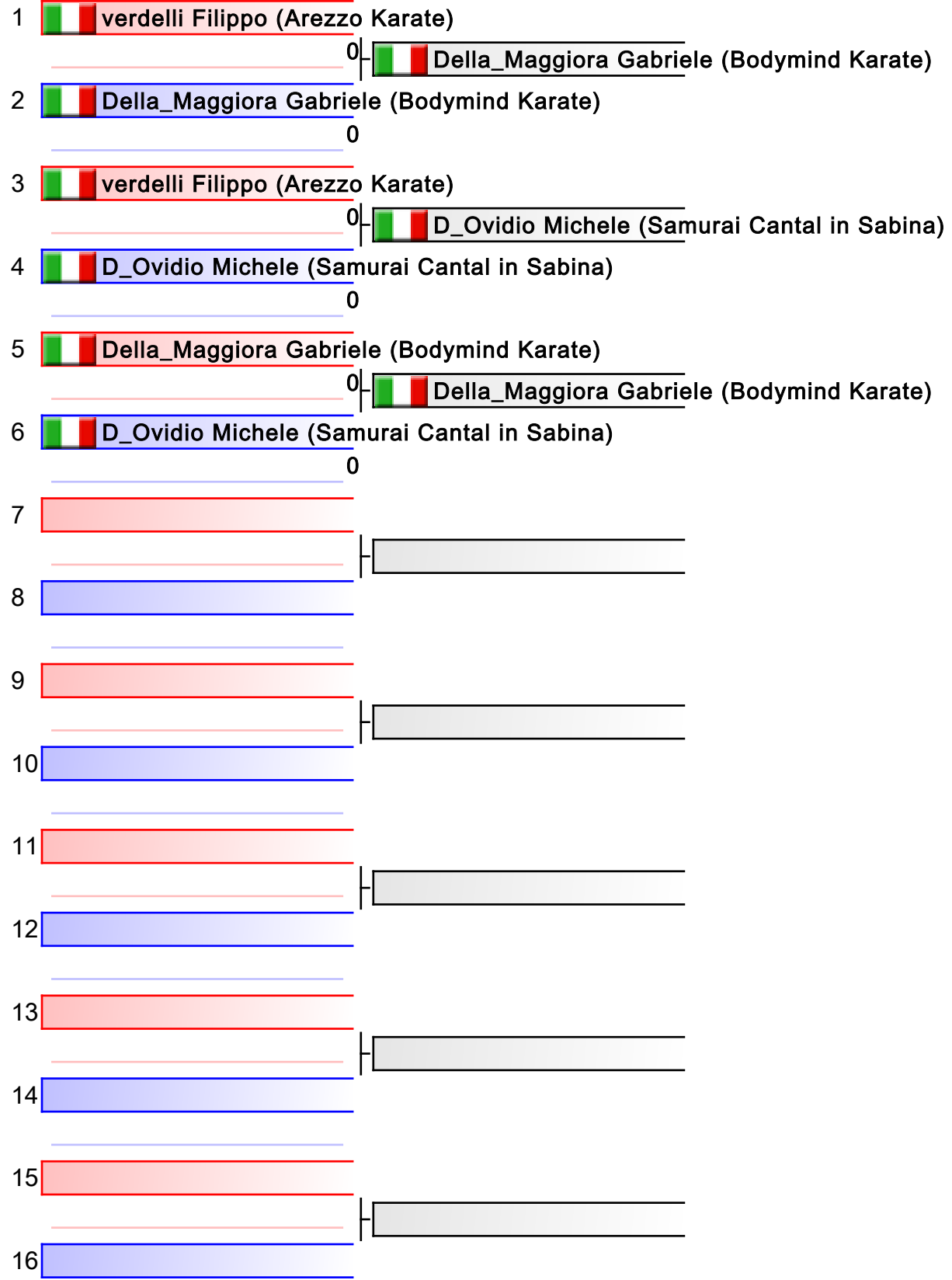

1. Della_Maggiora Gabriele (Bodymind Karate)
2. D_Ovidio Michele (Samurai Cantal in Sabina)
3. verdelli Filippo (Arezzo Karate)

Referees:			

B - Kumite M Sen 75 Kg
Trofeo Toscana Primavera

Tatami
3

Pool
1/1

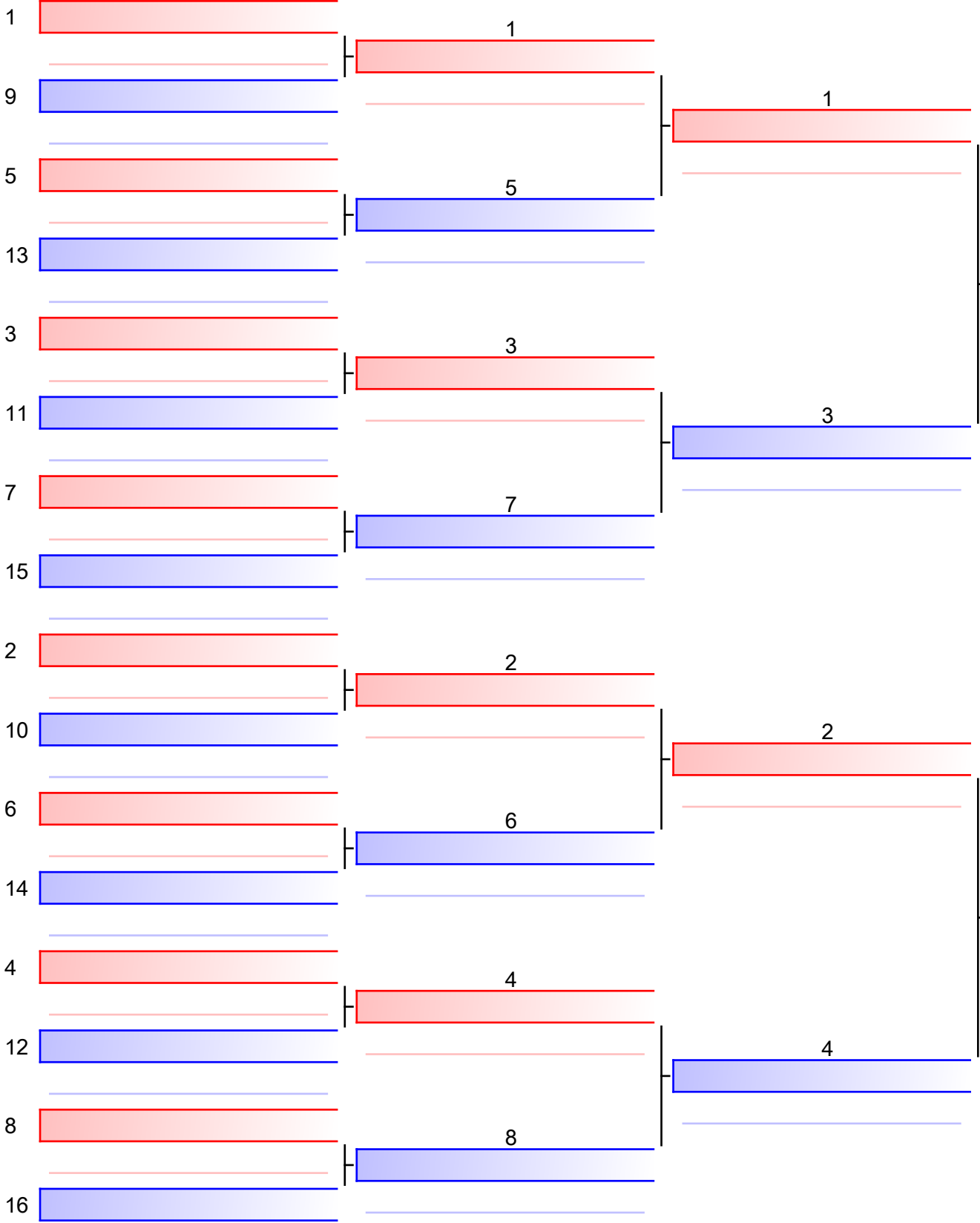

Final

FORTE FEDERICO (SHINGITAI PISA)

Stefanelli Emanuele (JOHNNY S KARATE)

1. Stefanelli Emanuele (JOHNNY S KARATE)
2. FORTE FEDERICO (SHINGITAI PISA)

Referees:			

Kata F Assoluti
Trofeo Toscana Primavera

Tatami
2

Pool
1/1

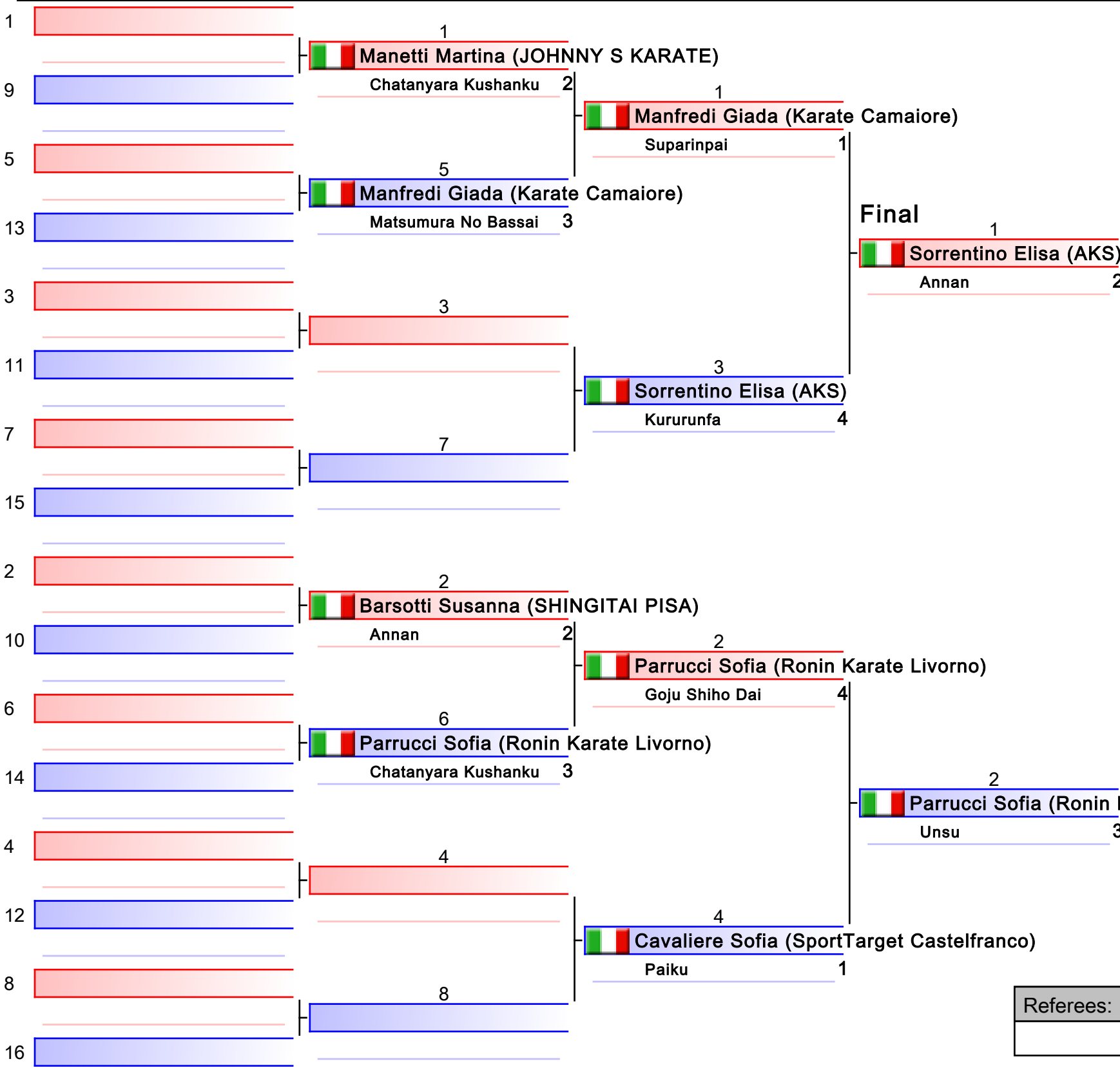

Parrucci Sofia (Ronin Karate Livorno)

1. Parrucci Sofia (Ronin Karate Livorno)
2. Sorrentino Elisa (AKS)
3. Manfredi Giada (Karate Camaio)
3. Cavaliere Sofia (SportTarget Castelfranco)
5. Barsotti Susanna (SHINGITAI PISA)

Referees:			

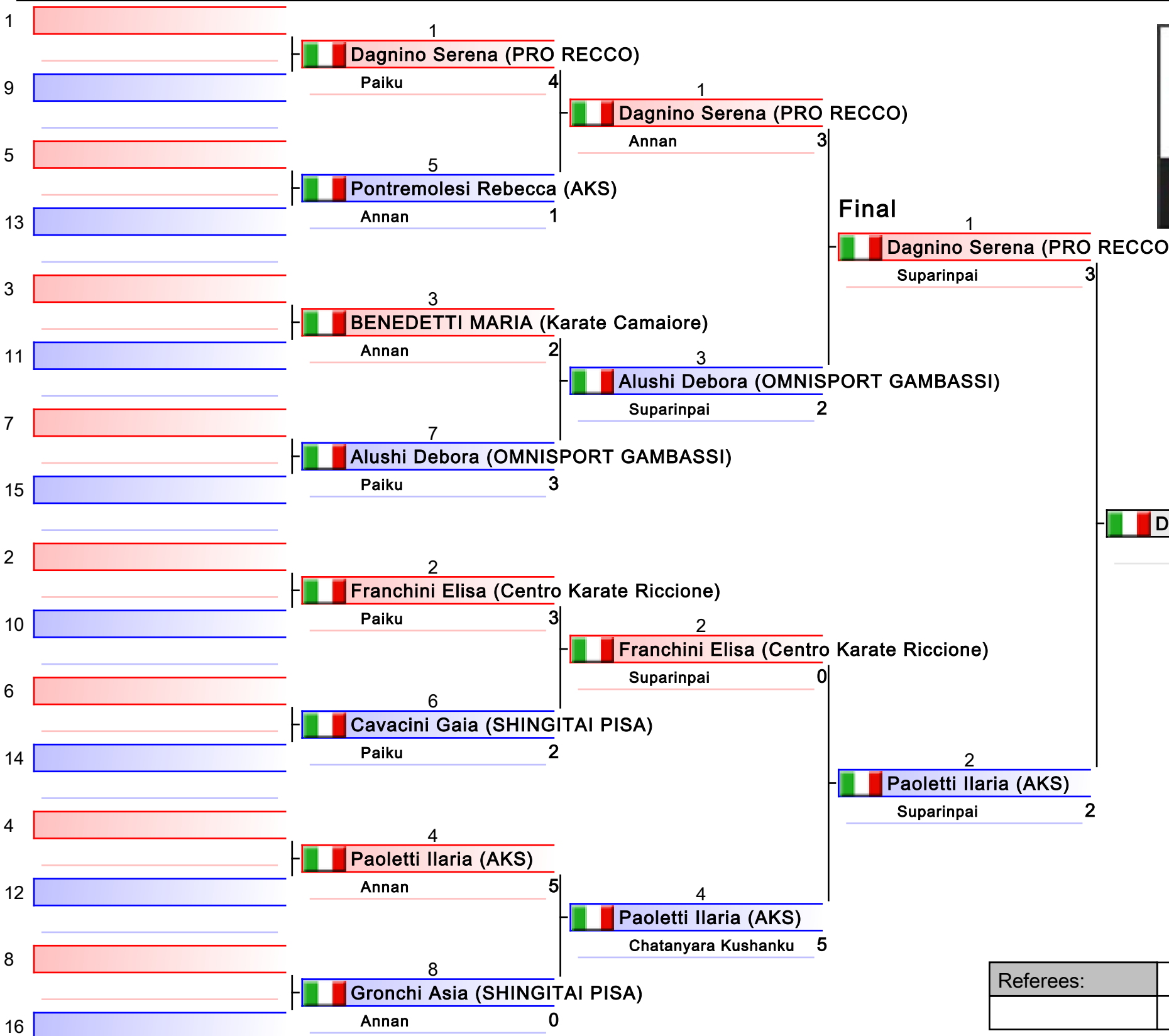

Dagnino Serena (PRO RECCO)

1. Dagnino Serena (PRO RECCO)
2. Paoletti Ilaria (AKS)
3. Pontremolesi Rebecca (AKS)
3. Franchini Elisa (Centro Karate Riccione)
5. Alushi Debora (OMNISPORT GAMBASSI)
5. Gronchi Asia (SHINGITAI PISA)

Referees:			

Kata F Es.A - Round Robin (each against each)

Trofeo Toscana Primavera

Tatami
1

Pool
1/1

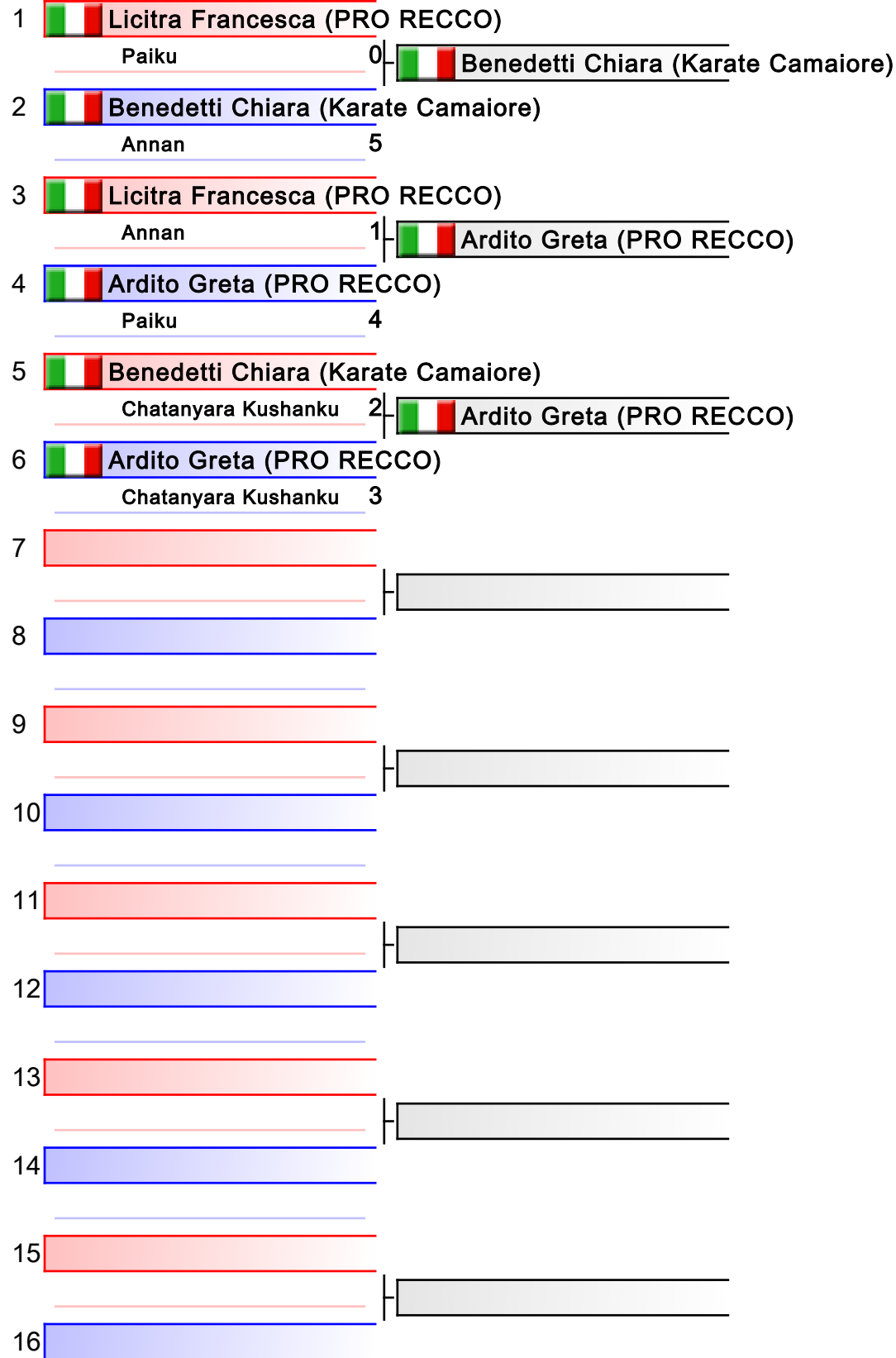

1. Ardito Greta (PRO RECCO)
2. Benedetti Chiara (Karate Camaiore)
3. Licitra Francesca (PRO RECCO)

Referees:			

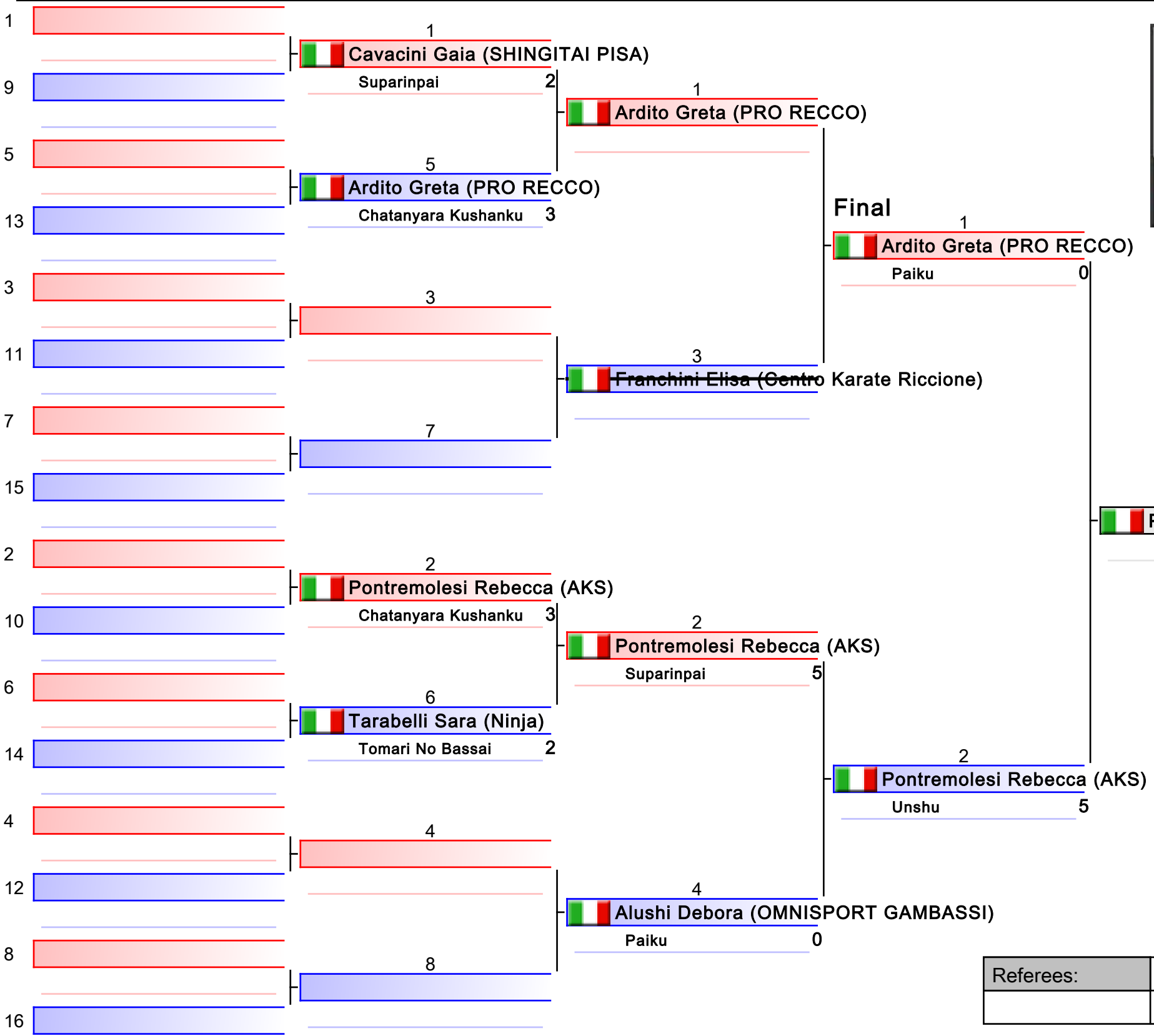

1. Pontremolesi Rebecca (AKS)
2. Ardito Greta (PRO RECCO)
3. Cavacini Gaia (SHINGITAI PISA)
3. Alushi Debora (OMNISPORT GAMBASSI)
5. Tarabelli Sara (Ninja)

Referees:			

Kata F Juniores

Trofeo Toscana Primavera

Tatami
4

Pool
1/1

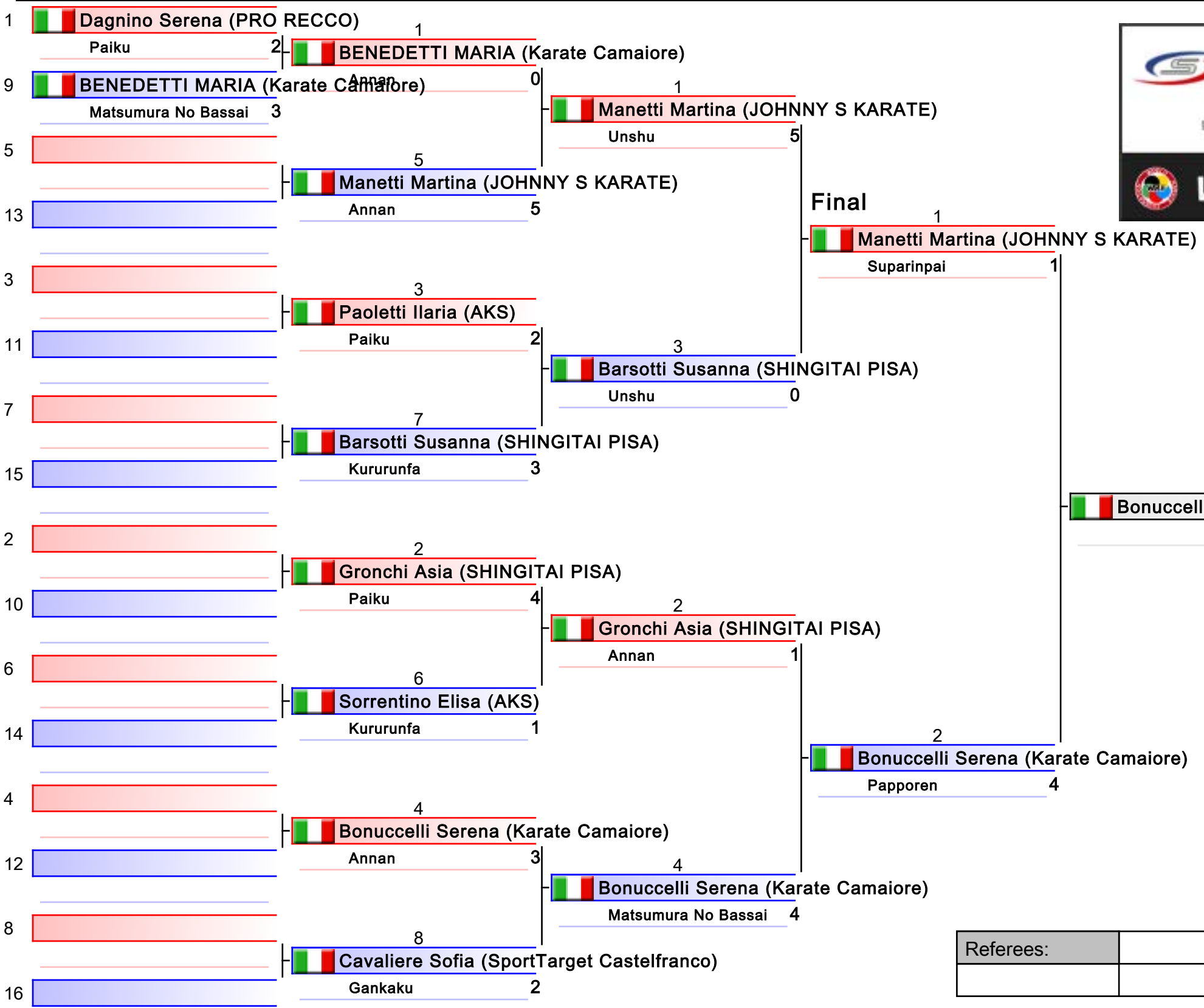

1. Bonuccelli Serena (Karate Camaioire)
2. Manetti Martina (JOHNNY S KARATE)
3. BENEDETTI MARIA (Karate Camaioire)
3. Gronchi Asia (SHINGITAI PISA)
5. Barsotti Susanna (SHINGITAI PISA)
5. Cavaliere Sofia (SportTarget Castelfranco)

Referees:			

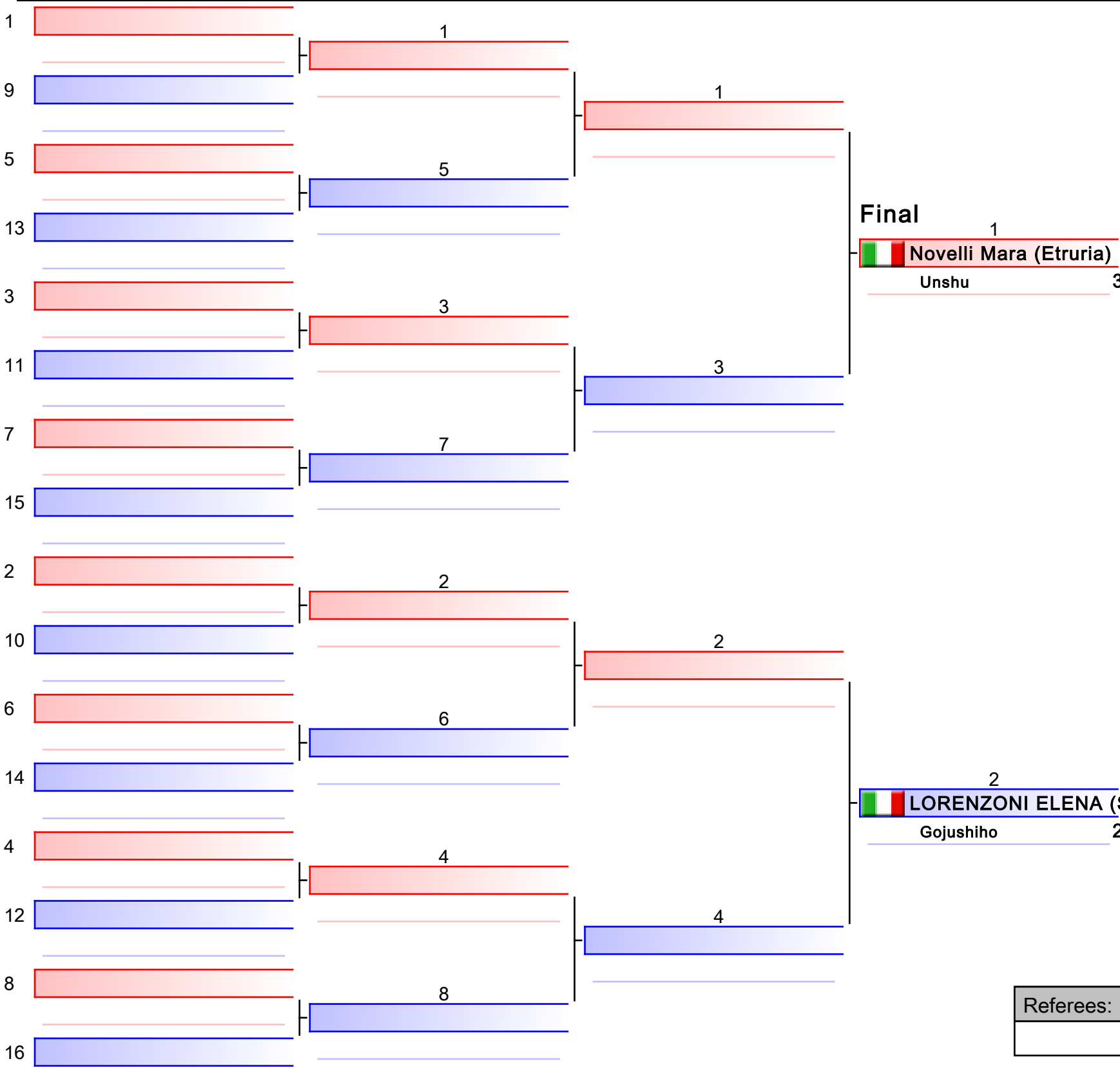

Novelli Mara (Etruria)

1. Novelli Mara (Etruria)
2. LORENZONI ELENA (Spazio Sport)

Referees:			

Kata M Assoluti
Trofeo Toscana Primavera

Tatami
1

Pool
1/1

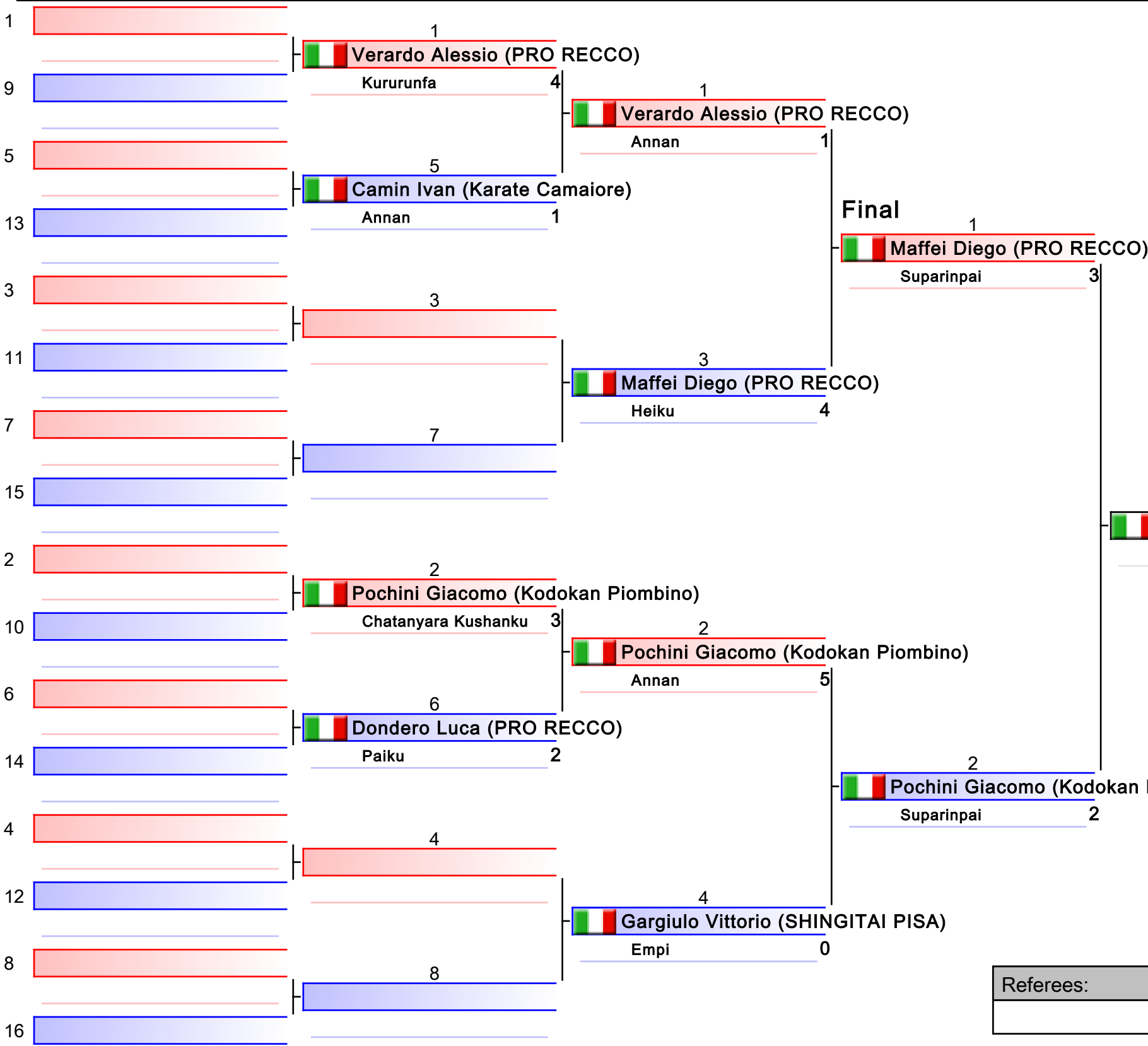

1. Maffei Diego (PRO RECCO)
2. Pochini Giacomo (Kodokan Piombino)
3. Verardo Alessio (PRO RECCO)
3. Dondero Luca (PRO RECCO)
5. Gargiulo Vittorio (SHINGITAI PISA)

Referees:			

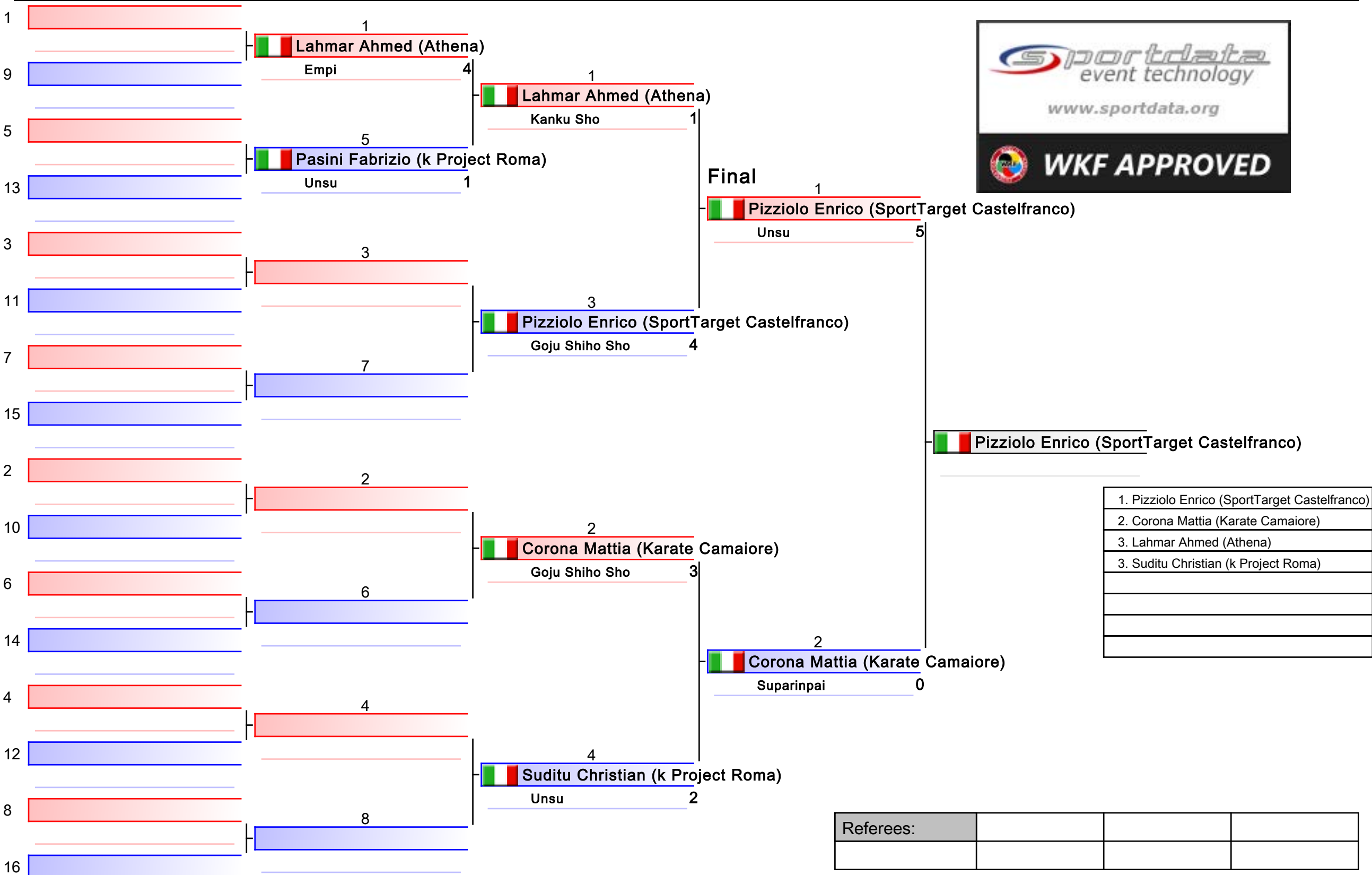

1. Pizziolo Enrico (SportTarget Castelfranco)
2. Corona Mattia (Karate Camaiore)
3. Lahmar Ahmed (Athena)
3. Suditu Christian (k Project Roma)

Referees:			

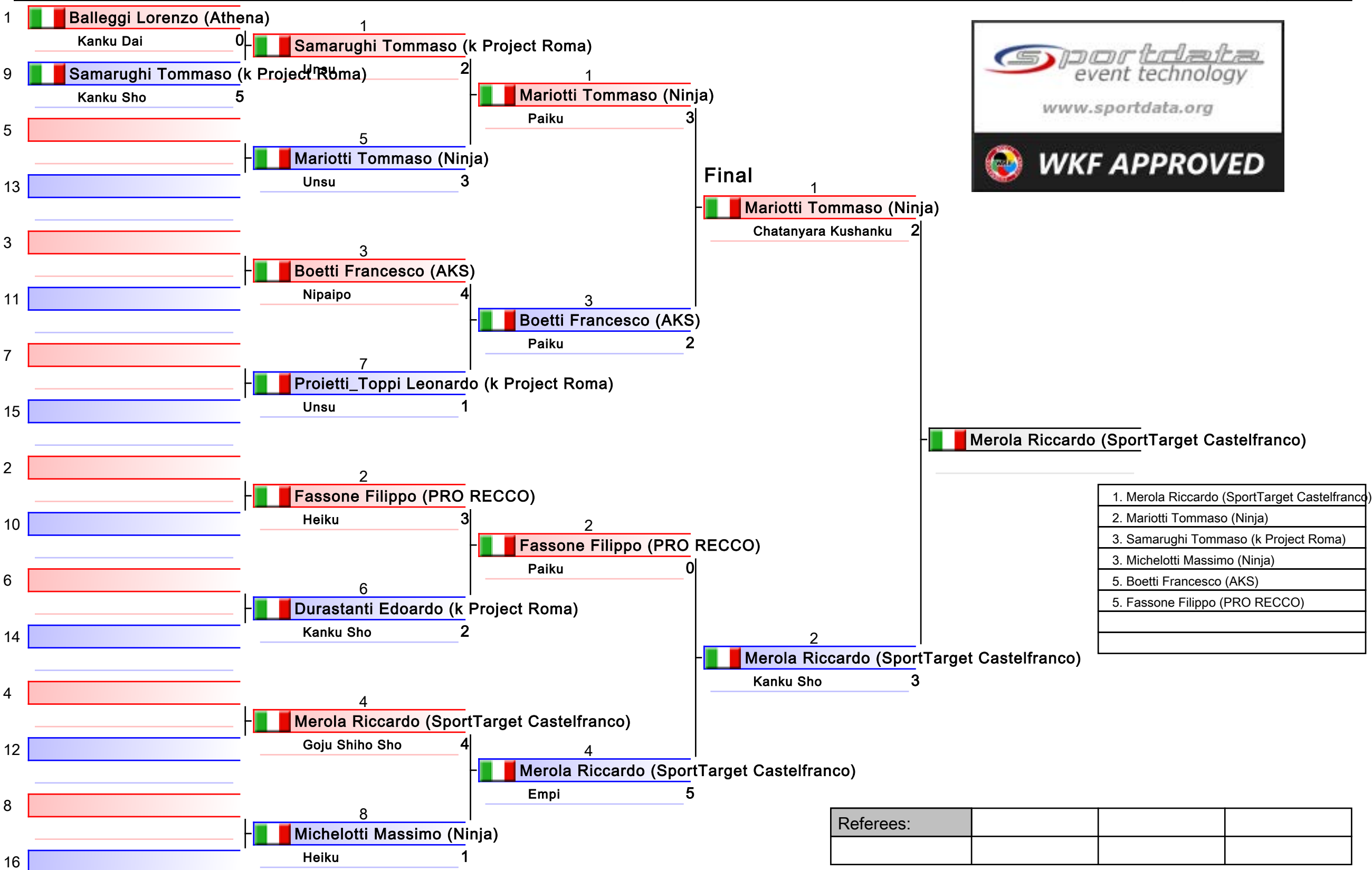

1. Merola Riccardo (SportTarget Castelfranco)
2. Mariotti Tommaso (Ninja)
3. Samarughi Tommaso (k Project Roma)
3. Michelotti Massimo (Ninja)
5. Boetti Francesco (AKS)
5. Fassone Filippo (PRO RECCO)

Referees:			

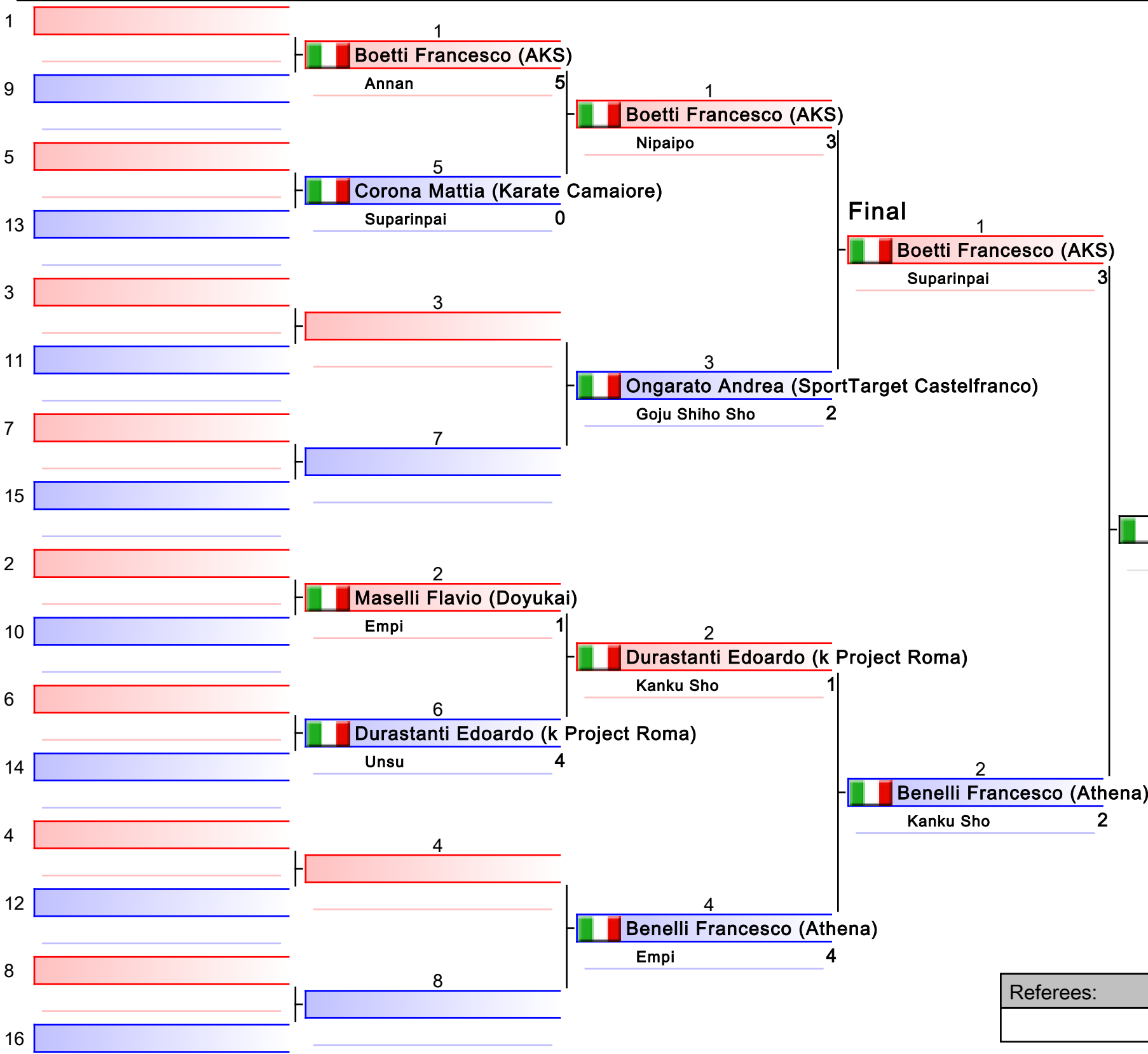

Boetti Francesco (AKS)

1. Boetti Francesco (AKS)
2. Benelli Francesco (Athena)
3. Durastanti Edoardo (k Project Roma)
3. Corona Mattia (Karate Camaiore)
5. Ongarato Andrea (SportTarget Castelfranco)

Referees:			

Kata M Juniores

Trofeo Toscana Primavera

Tatami
1

Pool
1/1

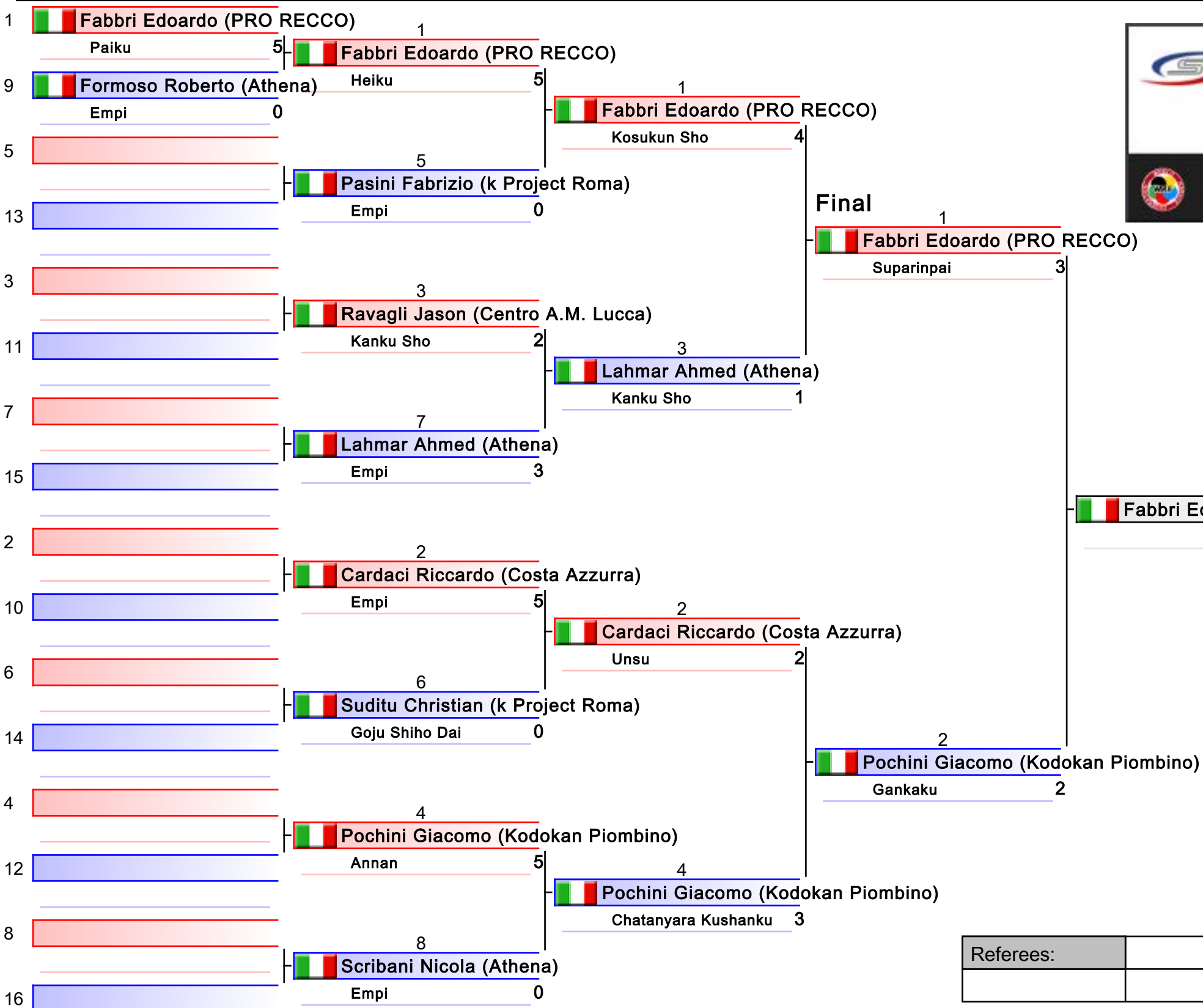

- | |
|---------------------------------------|
| 1. Fabbri Edoardo (PRO RECCO) |
| 2. Pochini Giacomo (Kodokan Piombino) |
| 3. Cardaci Riccardo (Costa Azzurra) |
| 3. Lahmar Ahmed (Athena) |
| 5. Scribani Nicola (Athena) |
| 5. Pasini Fabrizio (k Project Roma) |
| 7. Formoso Roberto (Athena) |
| |

Referees:			

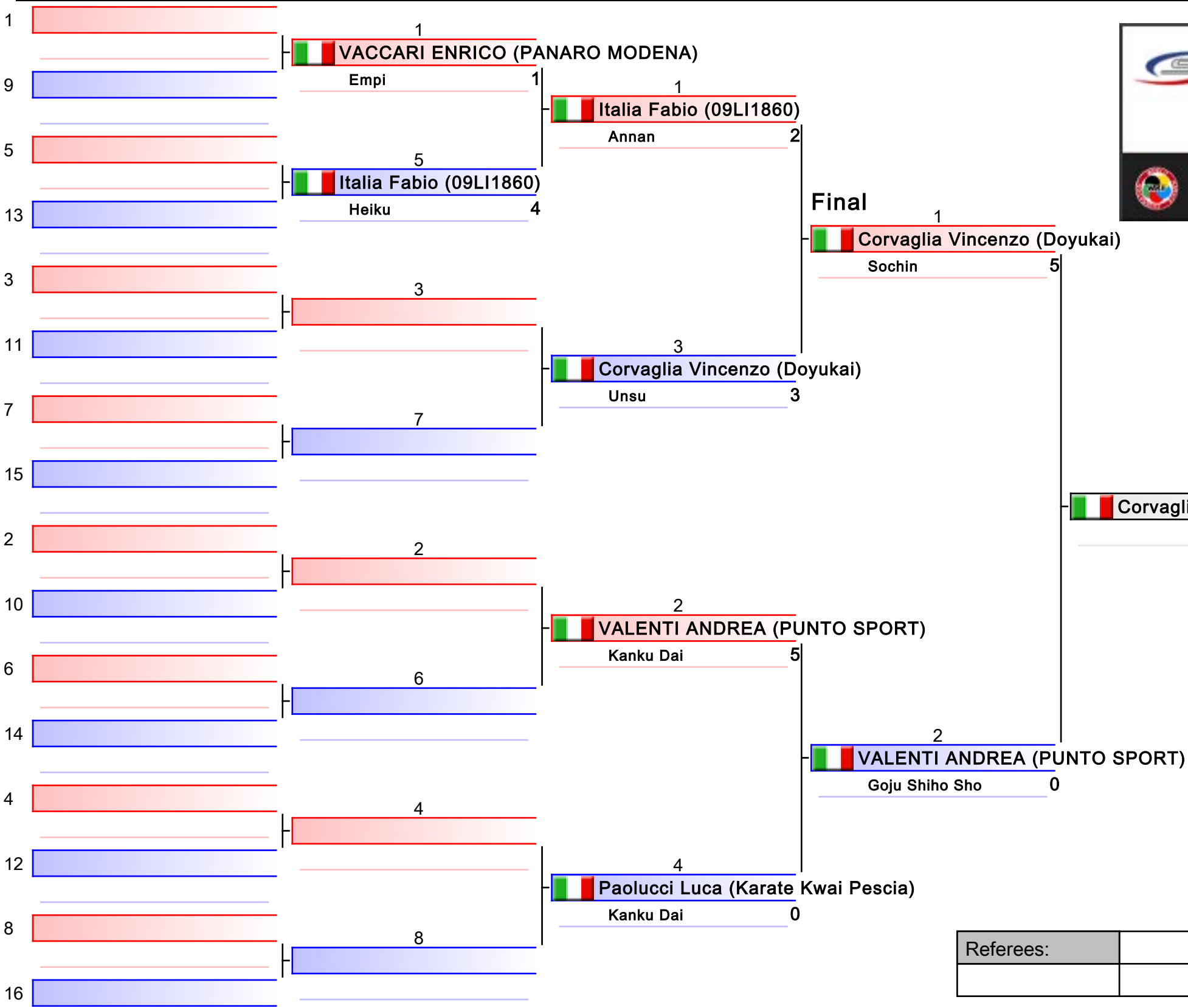

1. Corvaglia Vincenzo (Doyukai)
2. VALENTI ANDREA (PUNTO SPORT)
3. Italia Fabio (09LI1860)
3. Paolucci Luca (Karate Kwai Pescia)

Referees:			

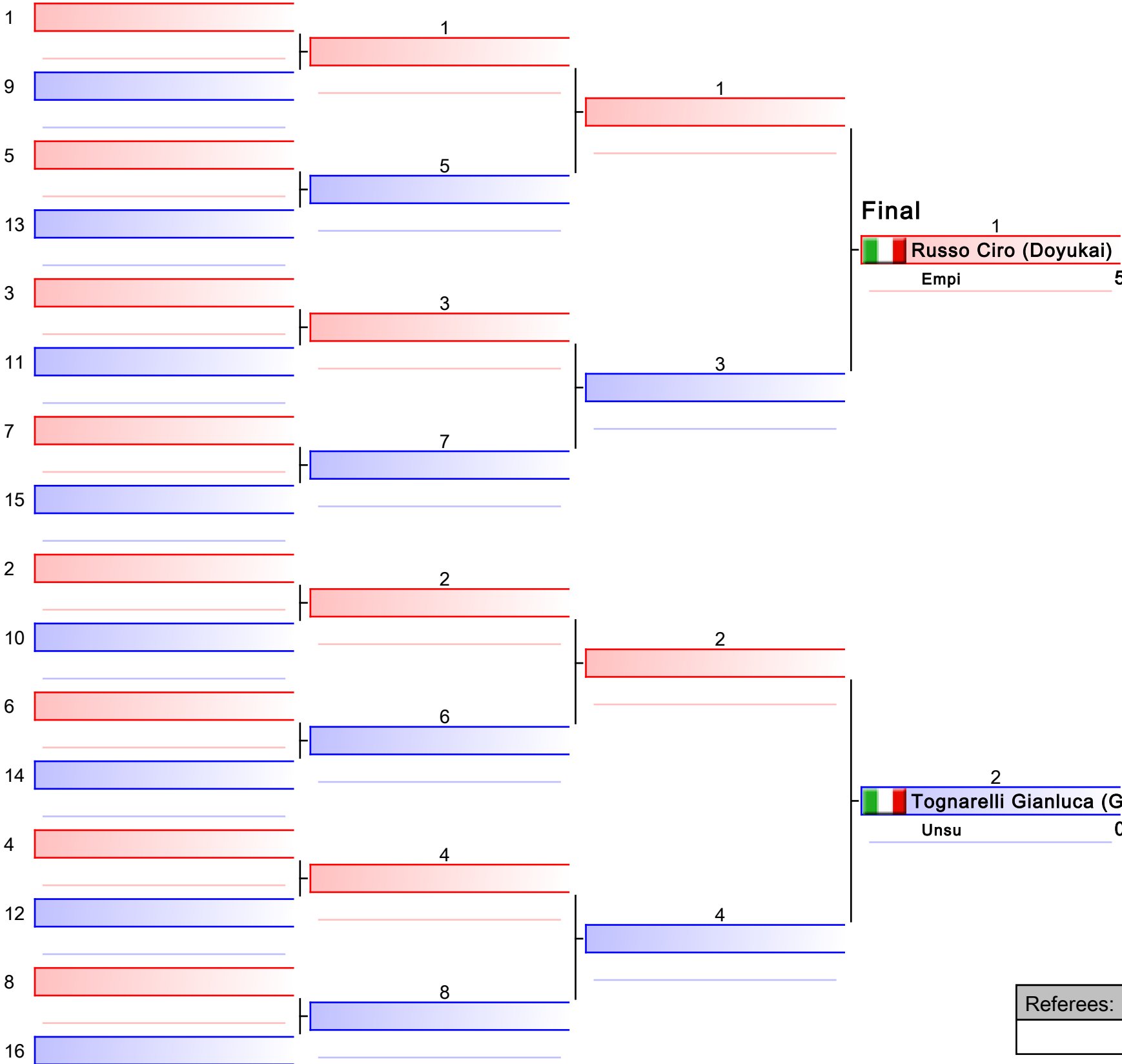

Russo Ciro (Doyukai)

1. Russo Ciro (Doyukai)
2. Tognarelli Gianluca (Goshin-do Barga)









Referees:			

Kata M MAS50 - Round Robin (each against each)

Trofeo Toscana Primavera

Tatami
4

Pool
1/1

1	 Filippini Paolo (SHINGITAI PISA) Kanku Sho 5	 Filippini Paolo (SHINGITAI PISA)
2	 VINCIGUERRA ANTONIO (PANARO MODENA) Sochin 0	
3	 Filippini Paolo (SHINGITAI PISA) Goju Shiho Sho 4	 Filippini Paolo (SHINGITAI PISA)
4	 Bini Valentino (Athena) Goju Shiho Sho 1	
5	 VINCIGUERRA ANTONIO (PANARO MODENA) Jion 3	 VINCIGUERRA ANTONIO (PANARO MODENA)
6	 Bini Valentino (Athena) Sochin 2	
7		
8		
9		
10		
11		
12		
13		
14		
15		
16		



1. Filippini Paolo (SHINGITAI PISA)
2. VINCIGUERRA ANTONIO (PANARO MODENA)
3. Bini Valentino (Athena)

Referees:			

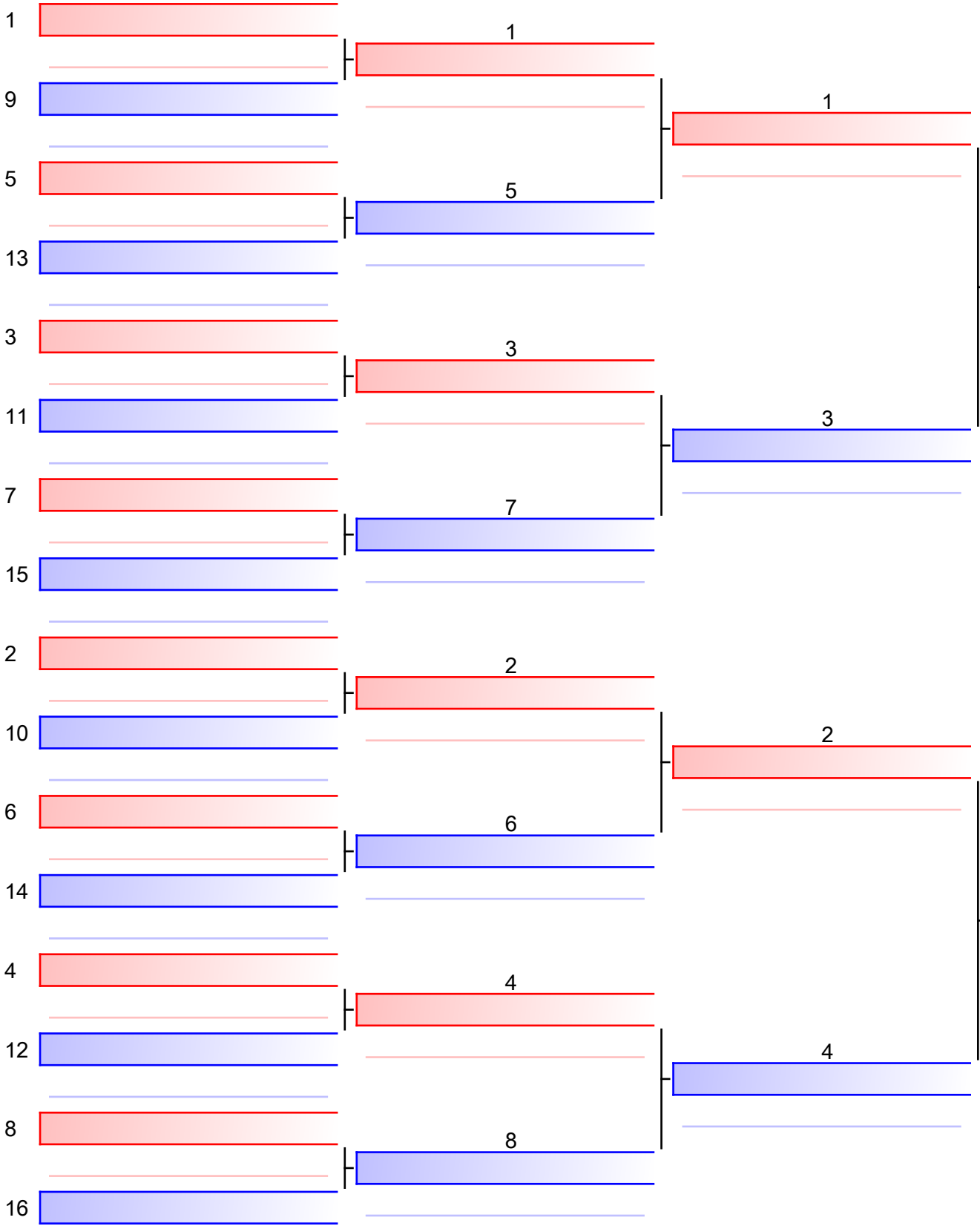

Final

1
ZIGLIOLI VALTER (PANARO MODENA)

Chatanyara Kushanku **2**

2
NARDI ALESSANDRO (Goshin-do Barga)

2
NARDI ALESSANDRO (Goshin-do Barga)

Goju Shiho Dai **3**

1. NARDI ALESSANDRO (Goshin-do Barga)
2. ZIGLIOLI VALTER (PANARO MODENA)

Referees:			

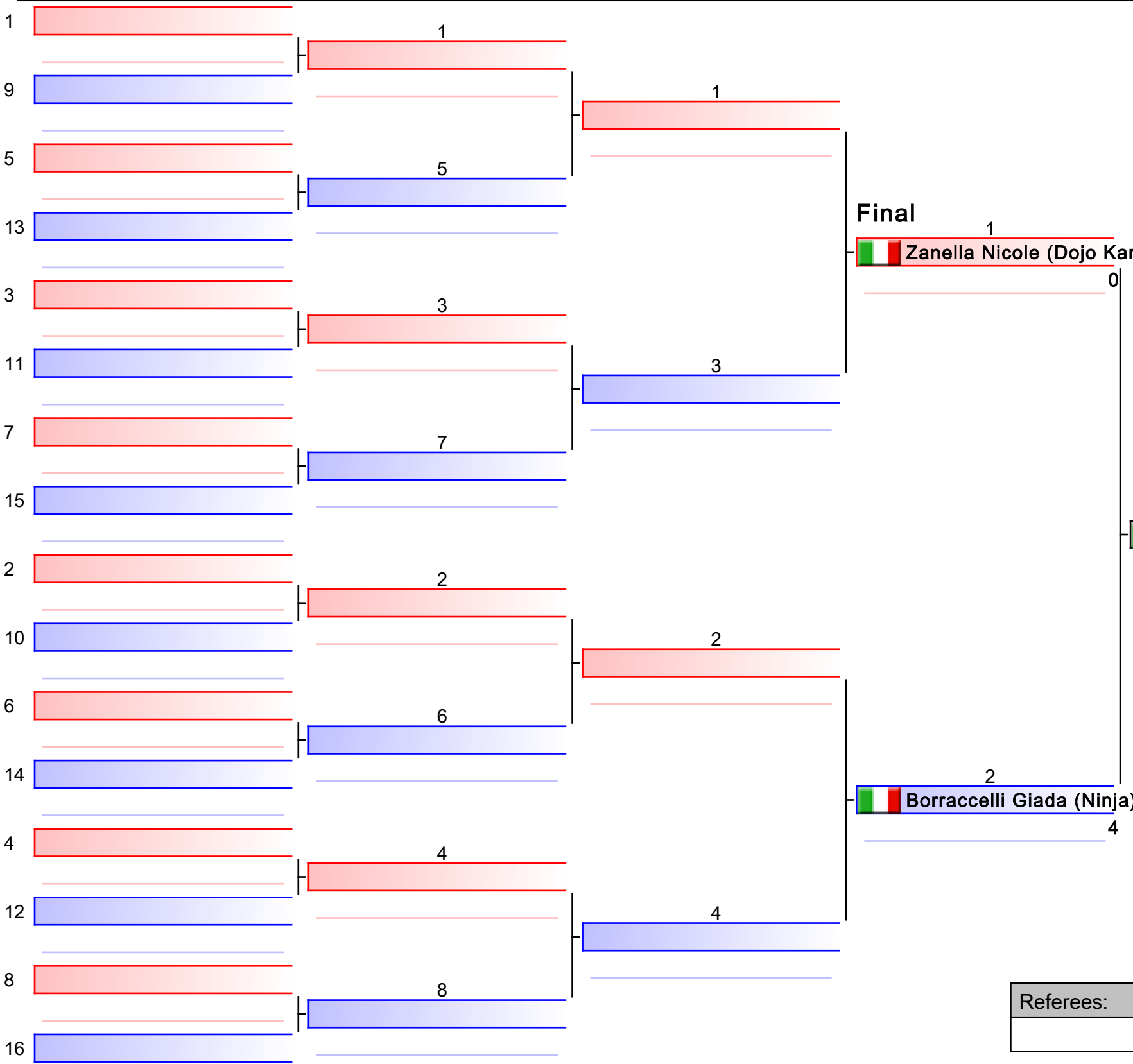

Borraccelli Giada (Ninja)

1. Borraccelli Giada (Ninja)
2. Zanella Nicole (Dojo Karate Lucca)

Referees:			

Kumite F CAD 53 Kg - Round Robin (each against each)

Trofeo Toscana Primavera

Tatami
3

Pool
1/1

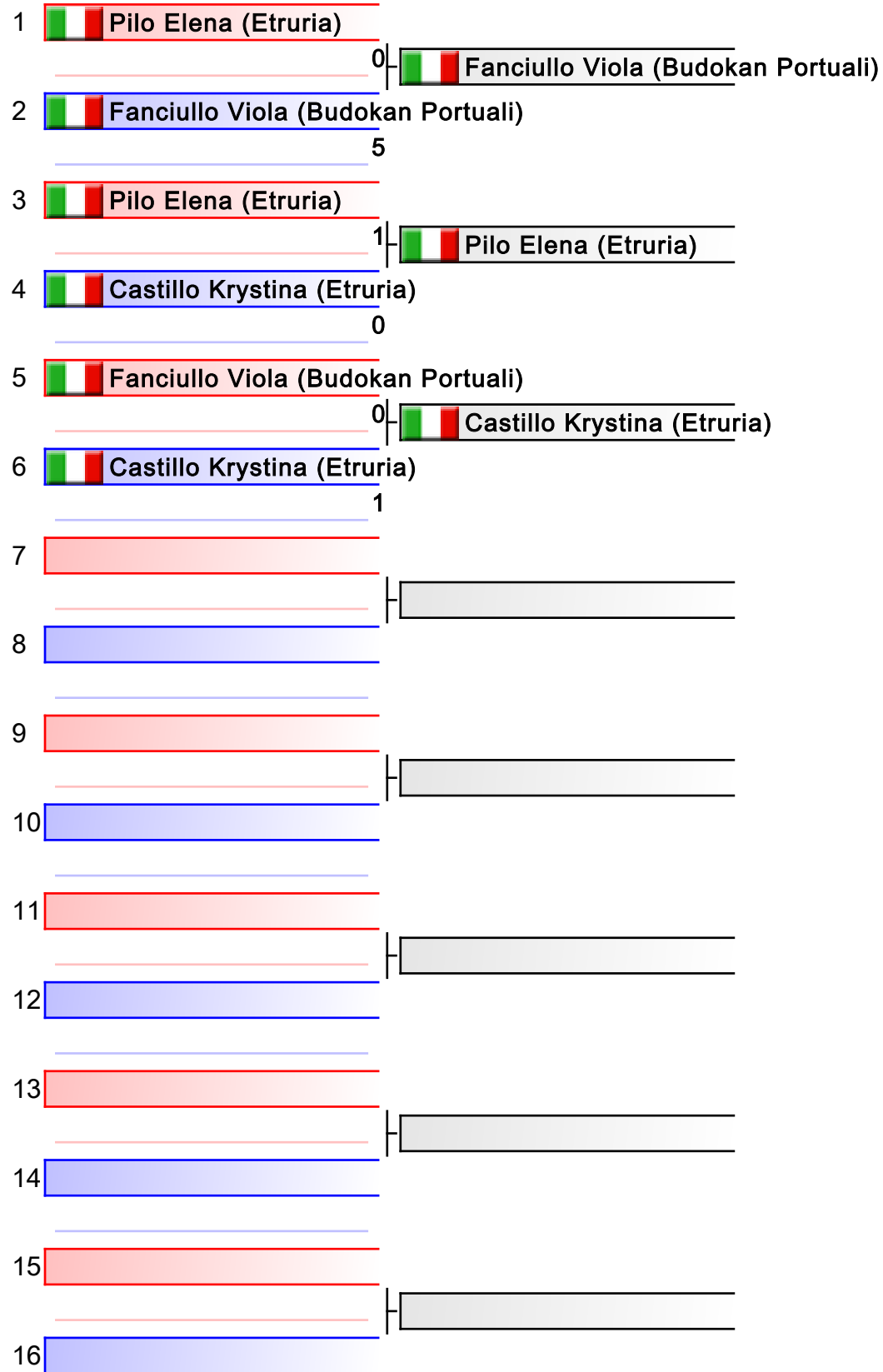

1. Fanciullo Viola (Budokan Portuali)
2. Castillo Krystina (Etruria)
3. Pilo Elena (Etruria)

Referees:			

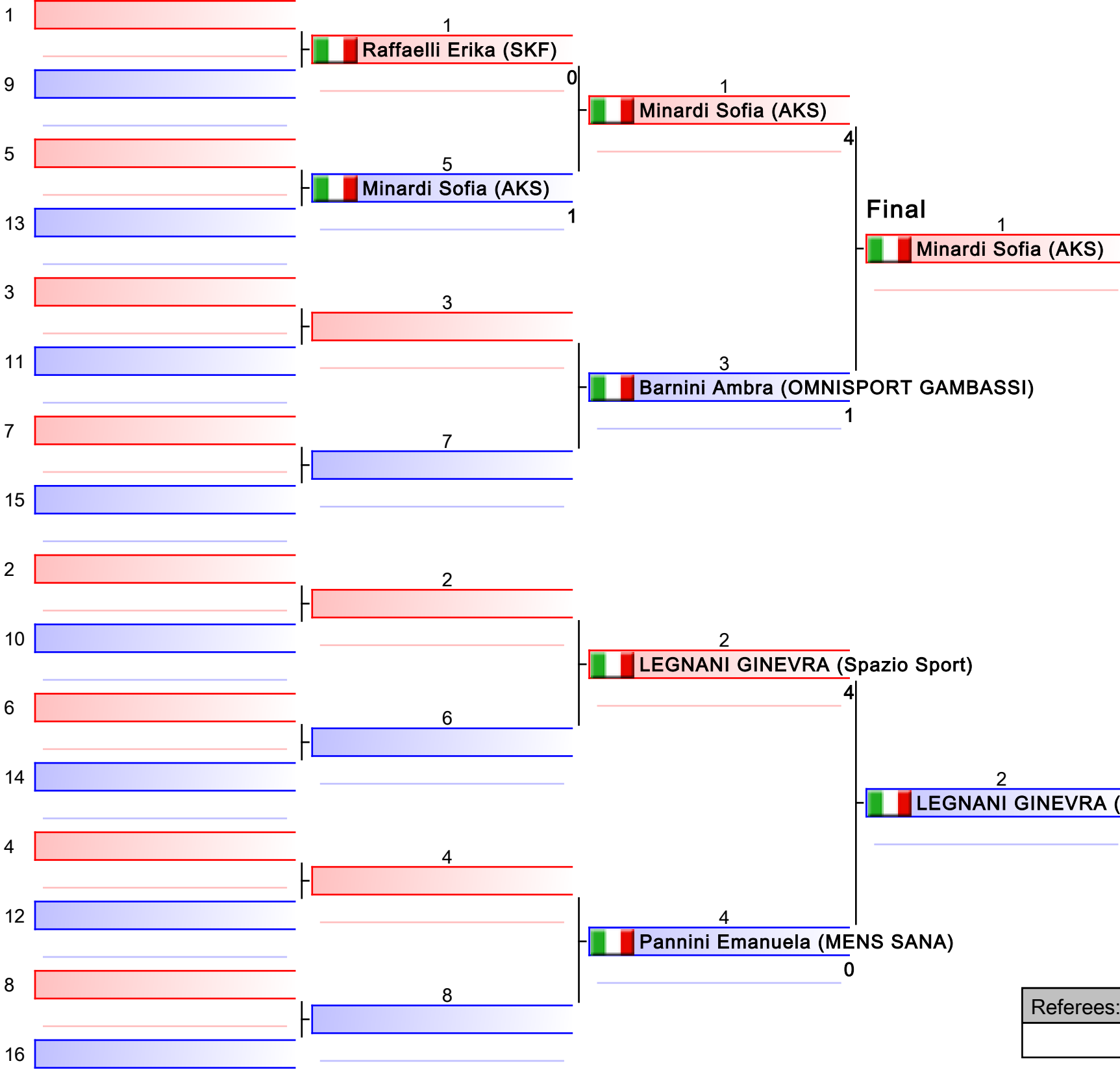

1. Minardi Sofia (AKS)
2. LEGNANI GINEVRA (Spazio Sport)
3. Pannini Emanuela (MENS SANA)
3. Raffaelli Erika (SKF)
5. Barnini Ambra (OMNISPORT GAMBASSI)

Referees:			

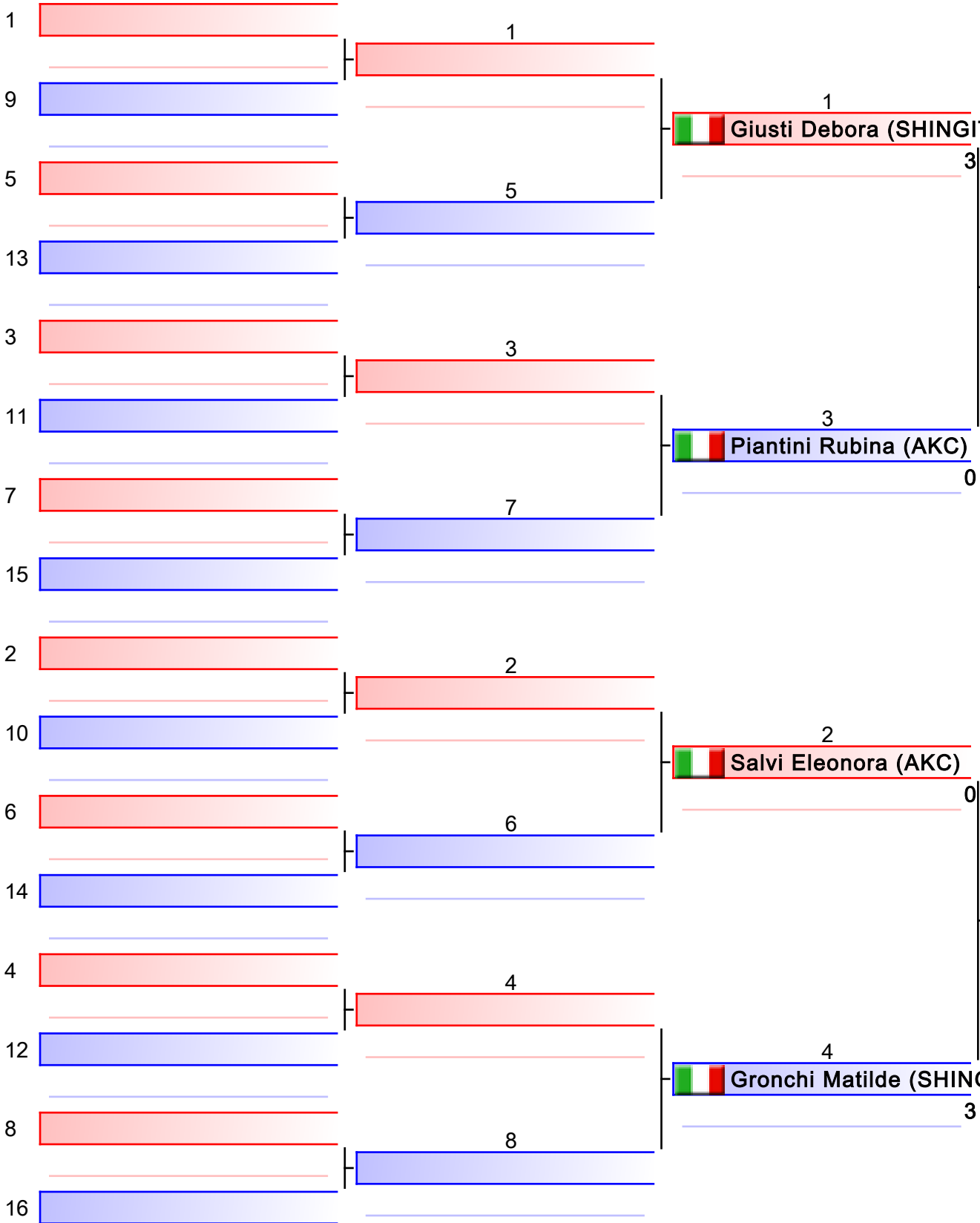

Final

1
Giusti Debora (SHINGITAI PISA) 3

Giusti Debora (SHINGITAI PISA)

2
Gronchi Matilde (SHINGITAI PISA) 0

1. Giusti Debora (SHINGITAI PISA)
2. Gronchi Matilde (SHINGITAI PISA)
3. Piantini Rubina (AKC)
3. Salvi Eleonora (AKC)

Referees:			

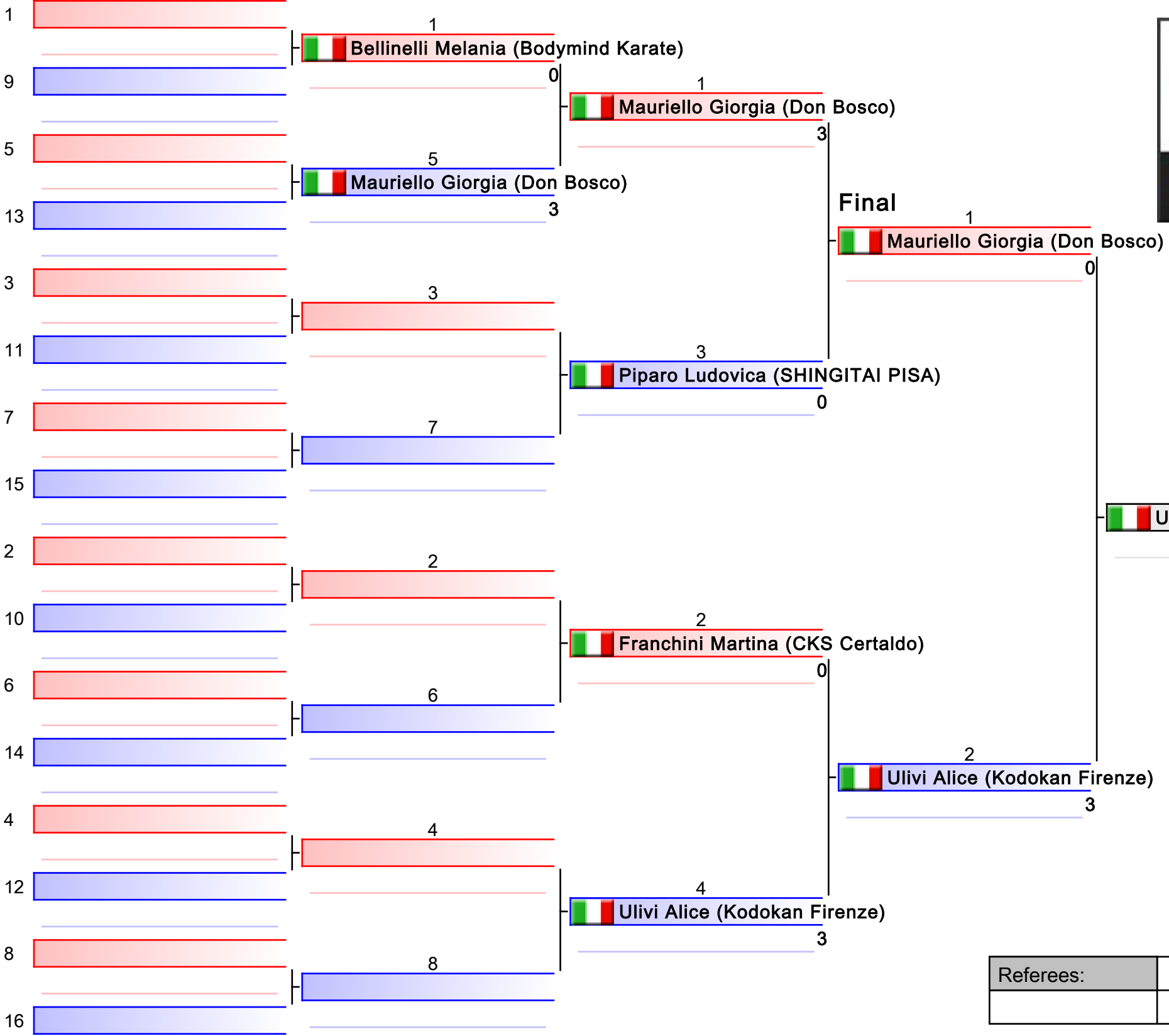

1. Ulivi Alice (Kodokan Firenze)
2. Mauriello Giorgia (Don Bosco)
3. Franchini Martina (CKS Certaldo)
3. Bellinelli Melania (Bodymind Karate)
5. Piparo Ludovica (SHINGITAI PISA)

Referees:			

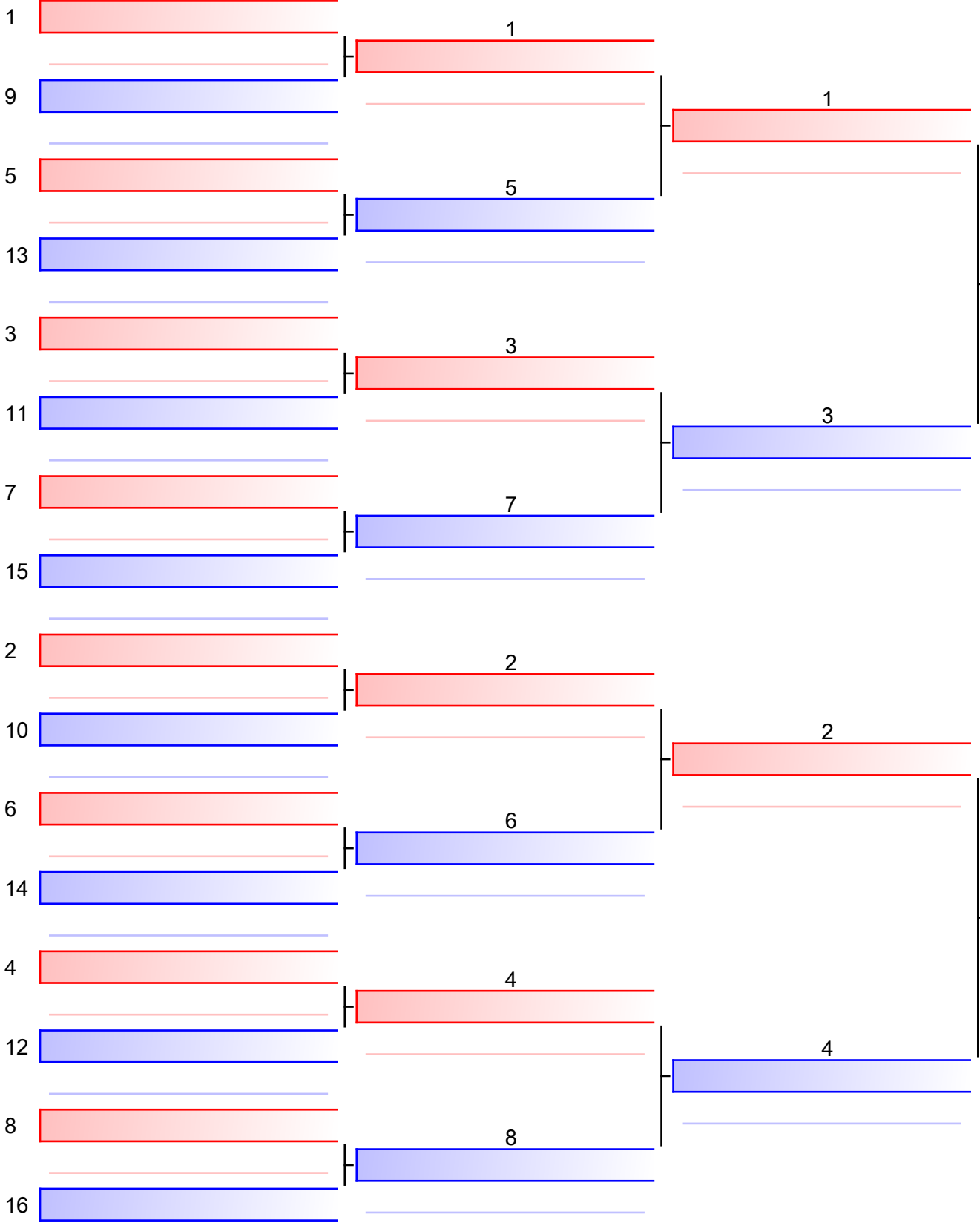

Final

Meregalli Emma (Bodymind Karate)

1
3

Meregalli Emma (Bodymind Karate)

Bartolomei Anita (Bodymind Karate)

2
0

1. Meregalli Emma (Bodymind Karate)
2. Bartolomei Anita (Bodymind Karate)

Referees:			

Kumite F Es.A 60 Kg - Round Robin (each against each)

Trofeo Toscana Primavera

Tatami

Pool
1/1

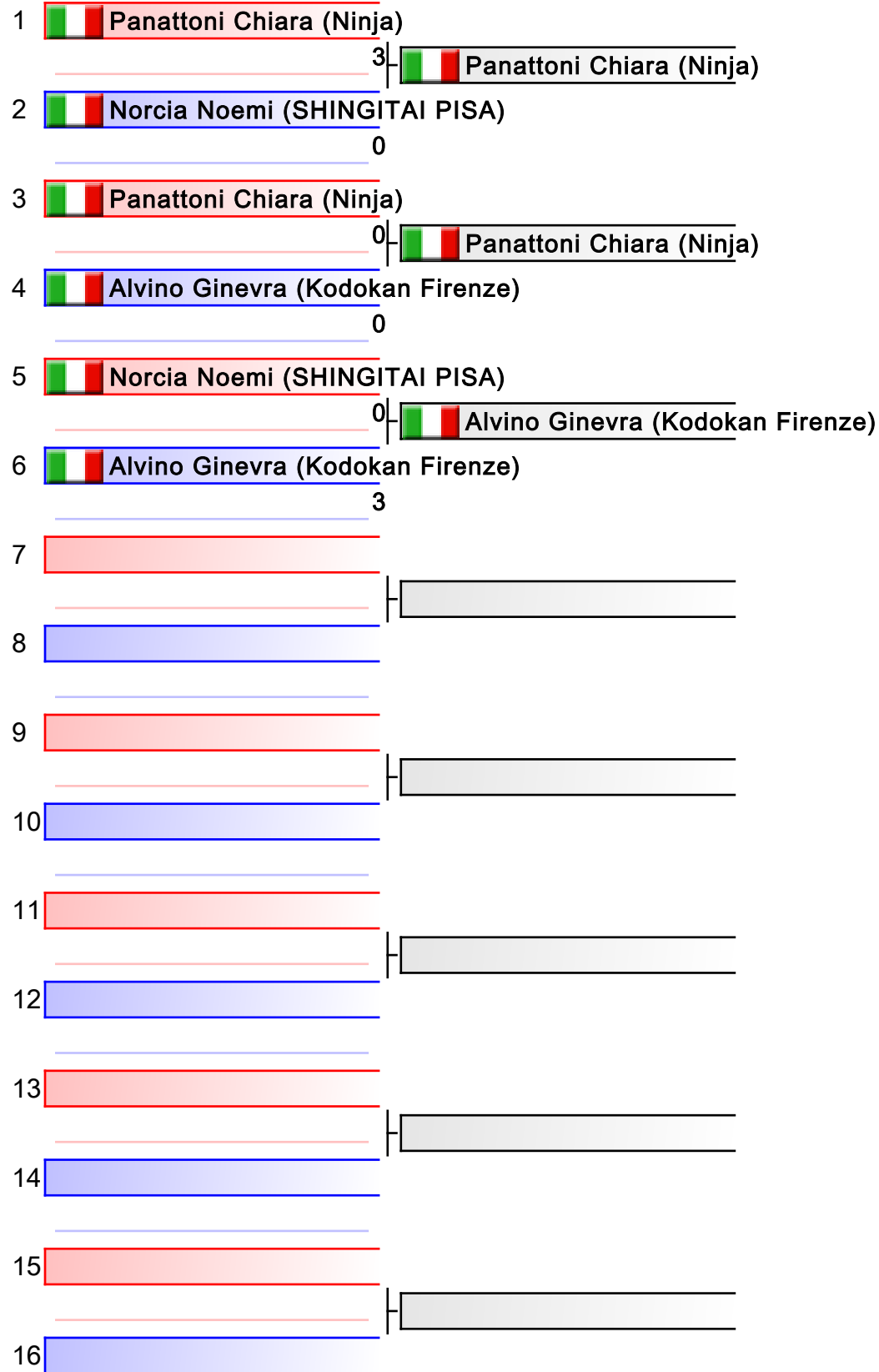

1. Panattoni Chiara (Ninja)
2. Alvino Ginevra (Kodokan Firenze)
3. Norcia Noemi (SHINGITAI PISA)

Referees:			

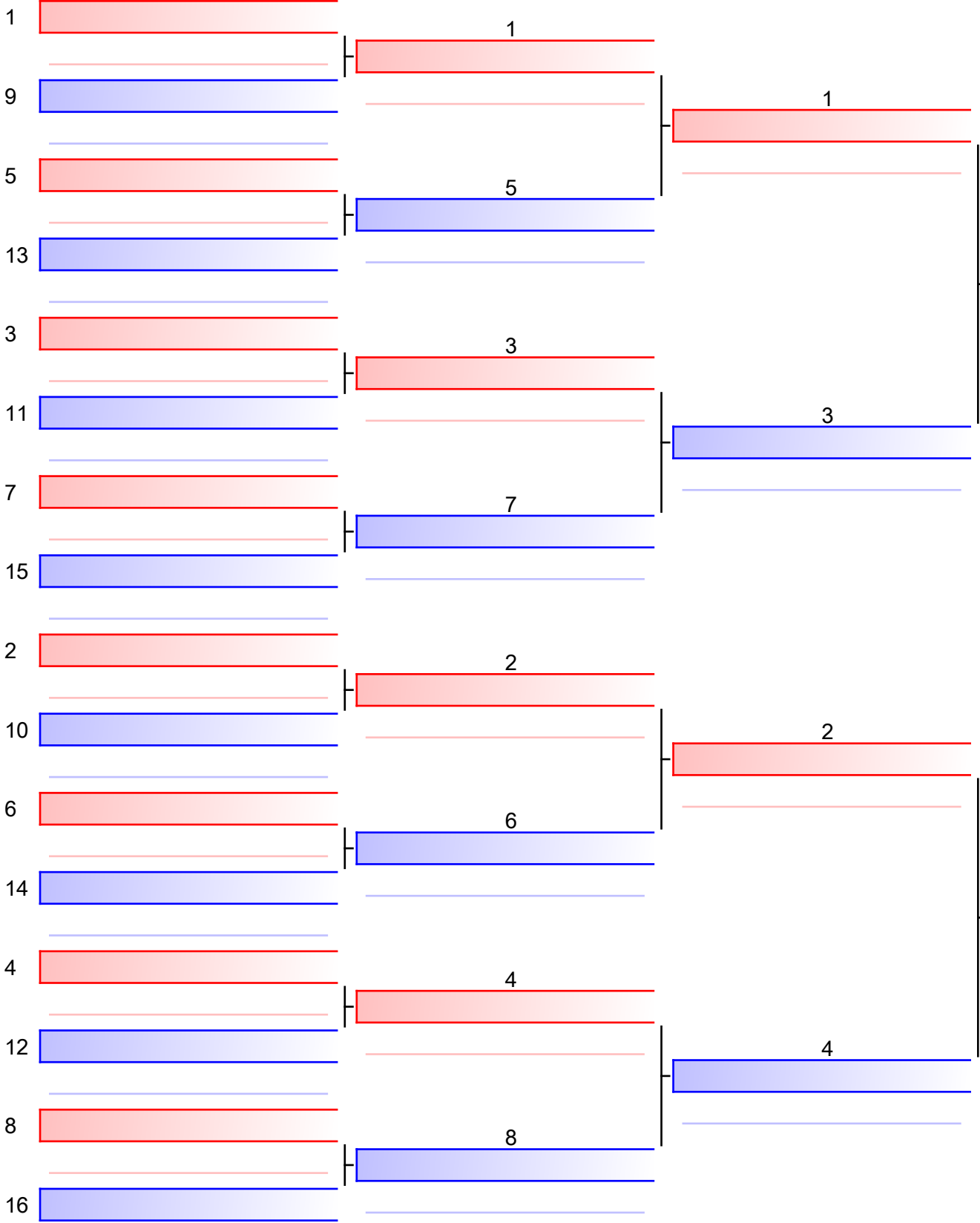

Final

Belvini Alice (SportTarget Castelfranco)

Gallorini Elisa (09AR3403)

Gallorini Elisa (09AR3403)

1. Gallorini Elisa (09AR3403)
2. Belvini Alice (SportTarget Castelfranco)

Referees:			

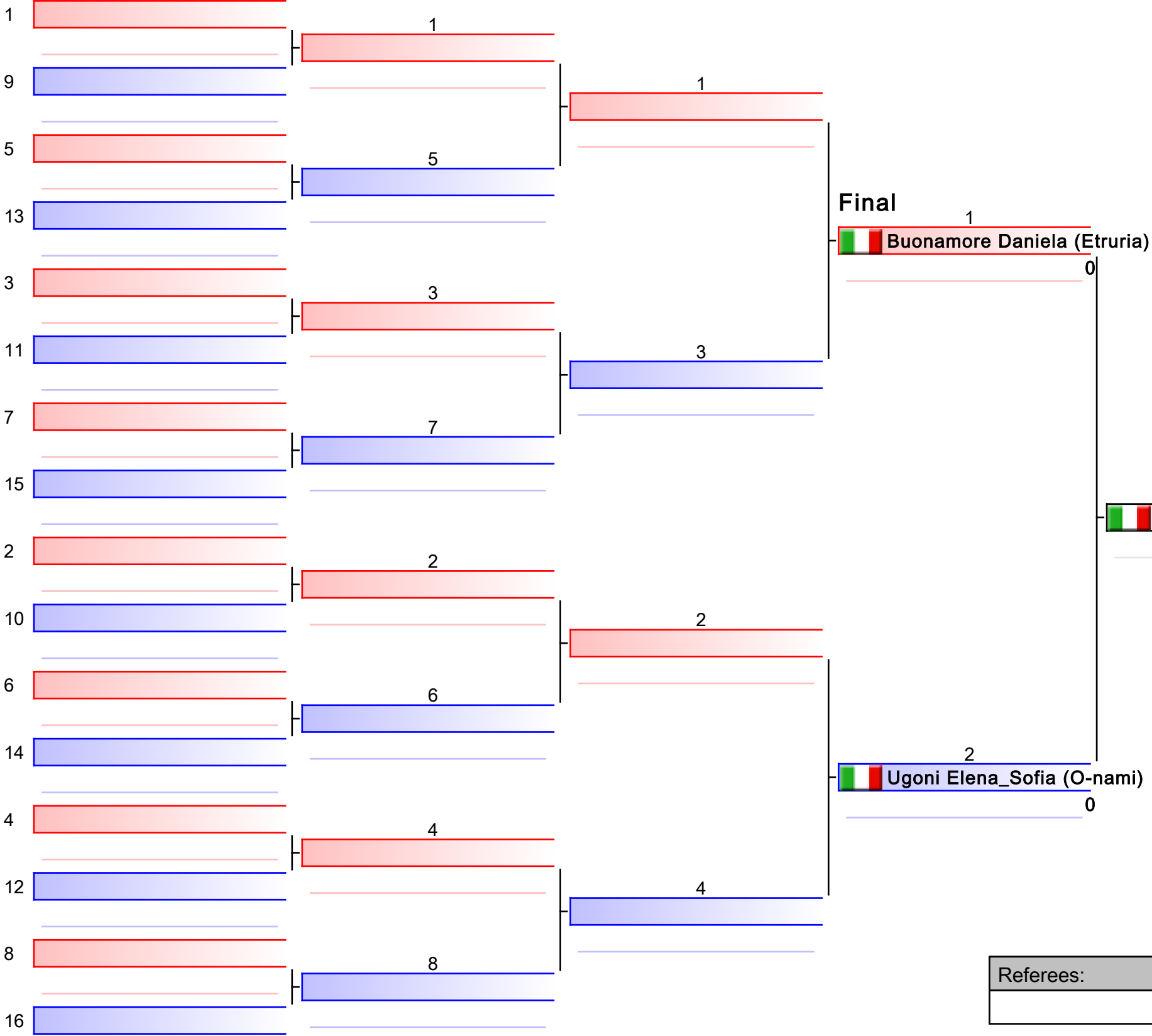

1. Ugoni Elena_Sofia (O-nami)
2. Buonomore Daniela (Etruria)

Referees:			

Kumite F Es.B 63 Kg - Round Robin (each against each)

Trofeo Toscana Primavera

Tatami
4

Pool
1/1

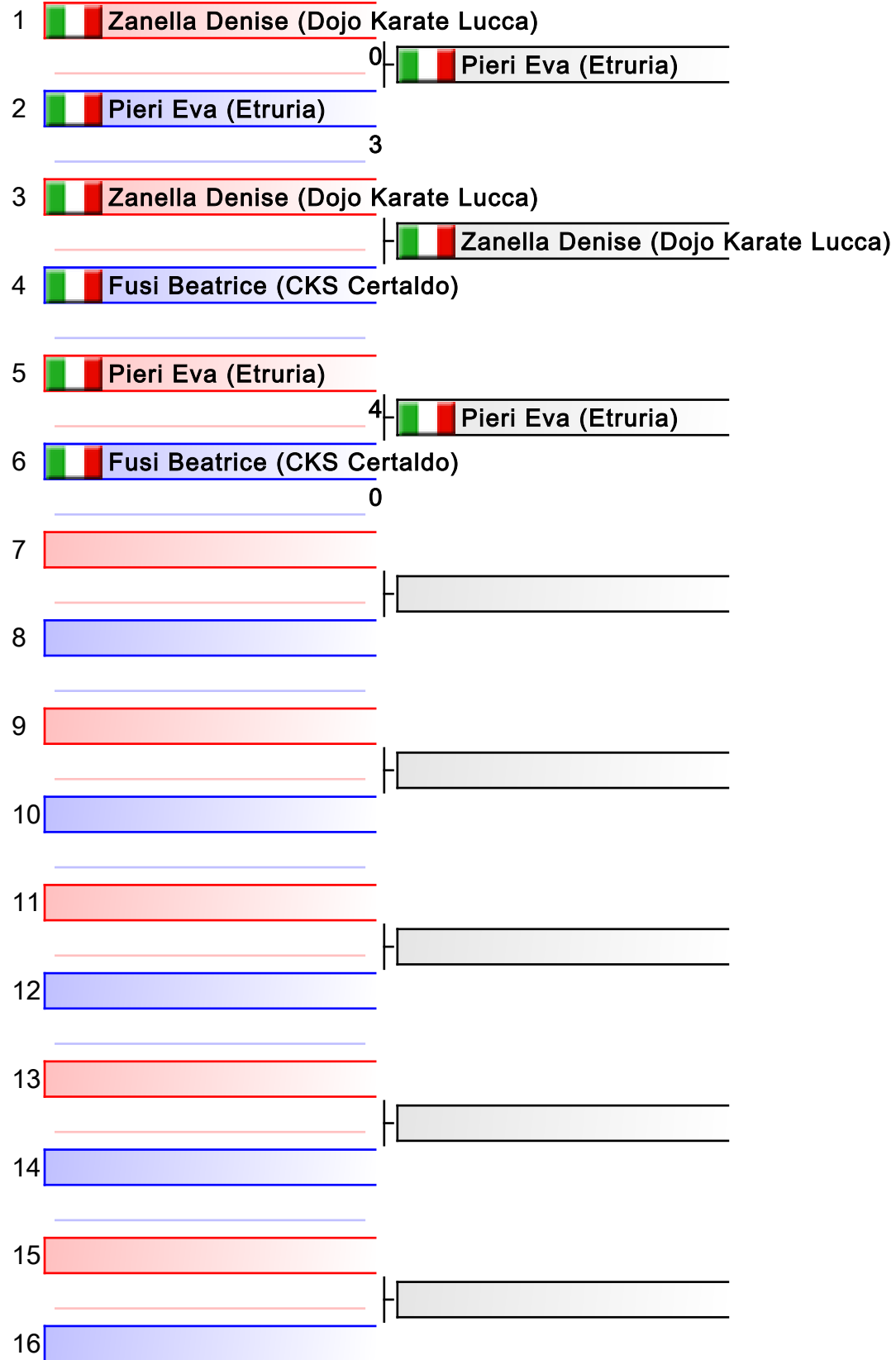

1. Pieri Eva (Etruria)
2. Zarella Denise (Dojo Karate Lucca)
3. Fusi Beatrice (CKS Certaldo)

Referees:			

Kumite F JUN +68 Kg
Trofeo Toscana Primavera

Tatami
2

Pool
1/1

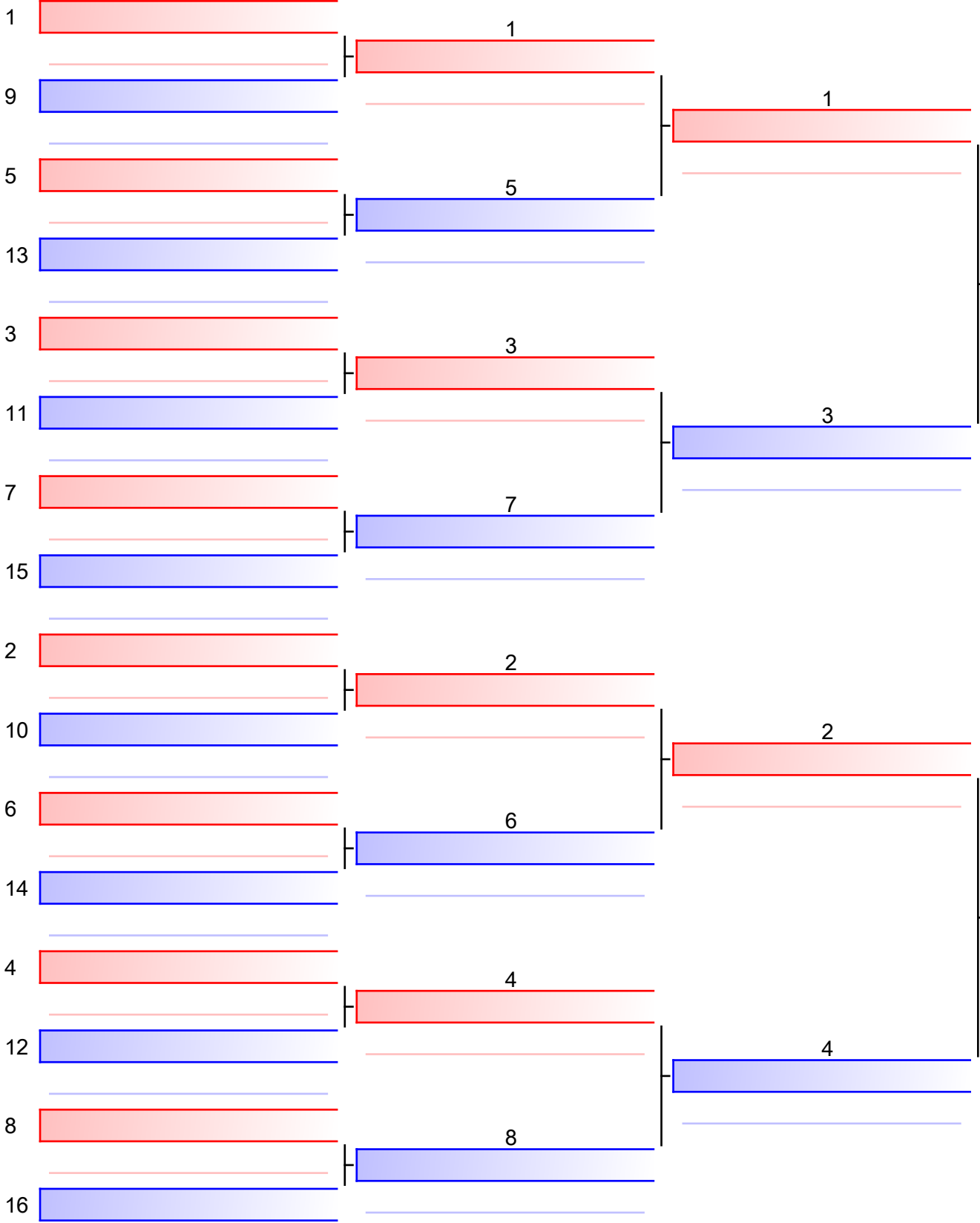

Final

1
🇮🇹 Metti Sara (AKS)

2
🇮🇹 Pratesi Gloria (OMNISPORT GAMBASSI)

1. Metti Sara (AKS)

Referees:			

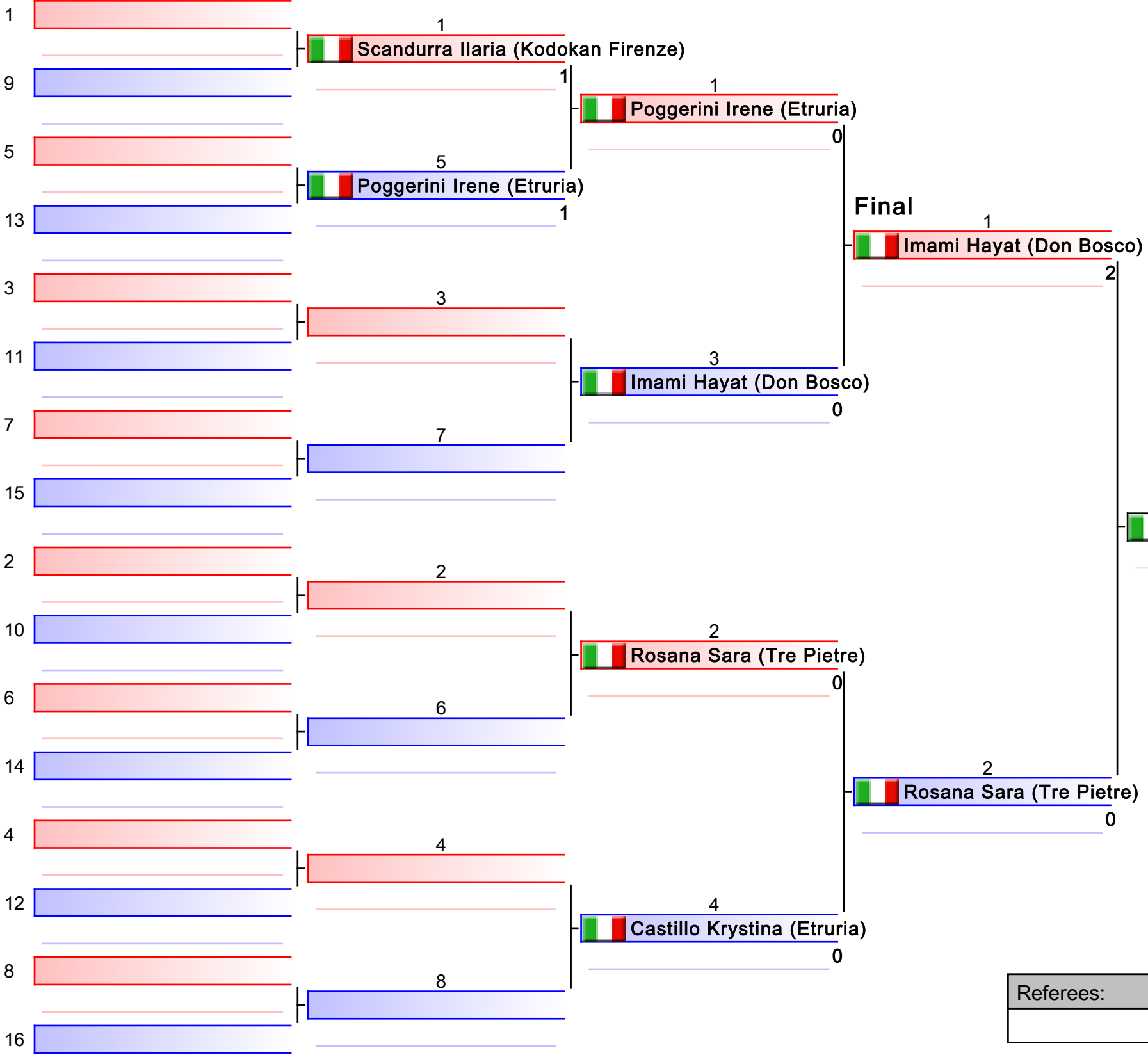

1. Imami Hayat (Don Bosco)
2. Rosana Sara (Tre Pietre)
3. Poggerini Irene (Etruria)
3. Castillo Krystina (Etruria)

Referees:			

Kumite F JUN -61 Kg
Trofeo Toscana Primavera

Tatami
2

Pool
1/1

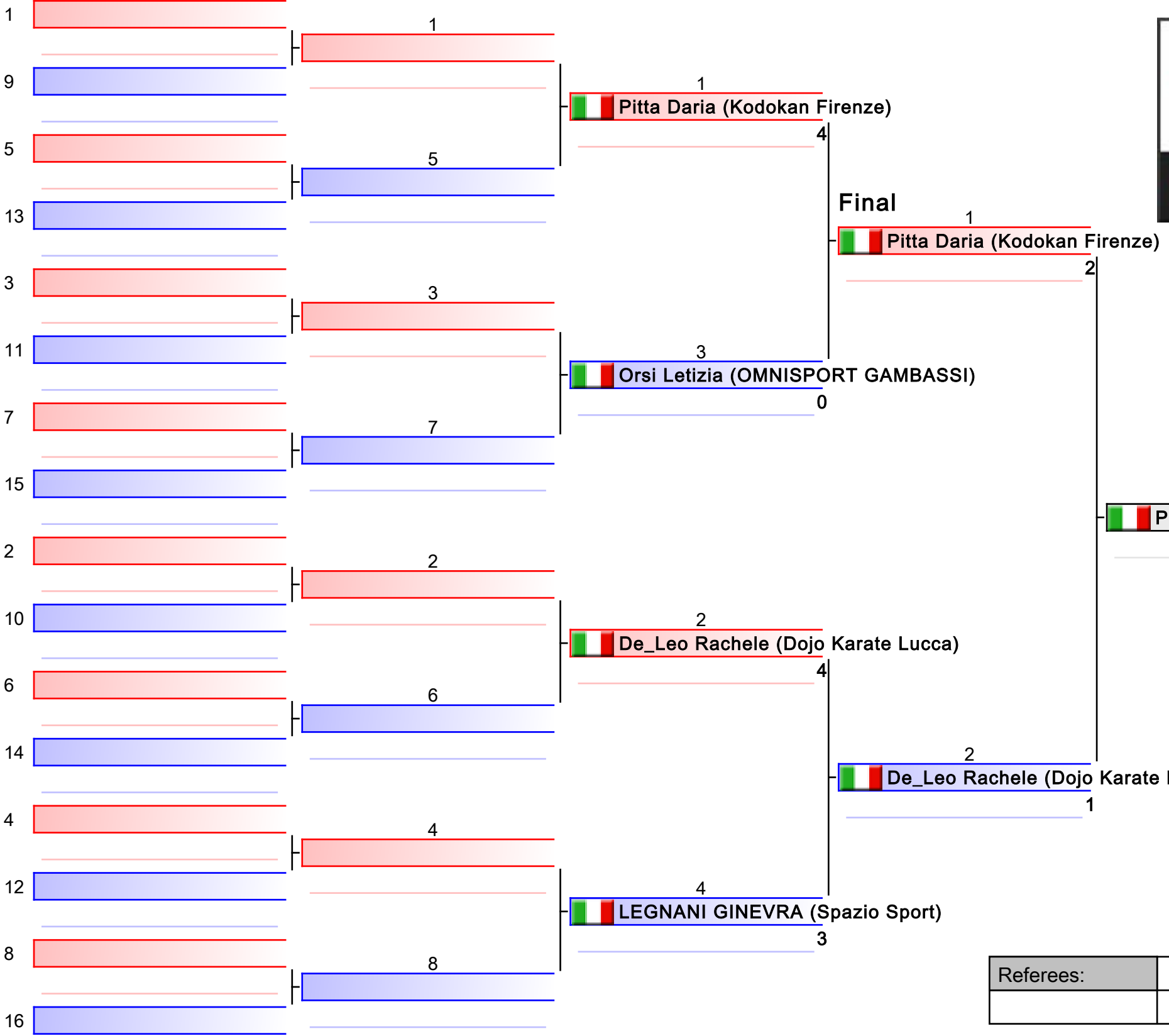

1. Pitta Daria (Kodokan Firenze)
2. De_Leo Rachele (Dojo Karate Lucca)
3. Orsi Letizia (OMNISPORT GAMBASSI)
3. LEGNANI GINEVRA (Spazio Sport)

Referees:			

Kumite F SEN +68 Kg - Round Robin (each against each)

Trofeo Toscana Primavera

Tatami
4

Pool
1/1

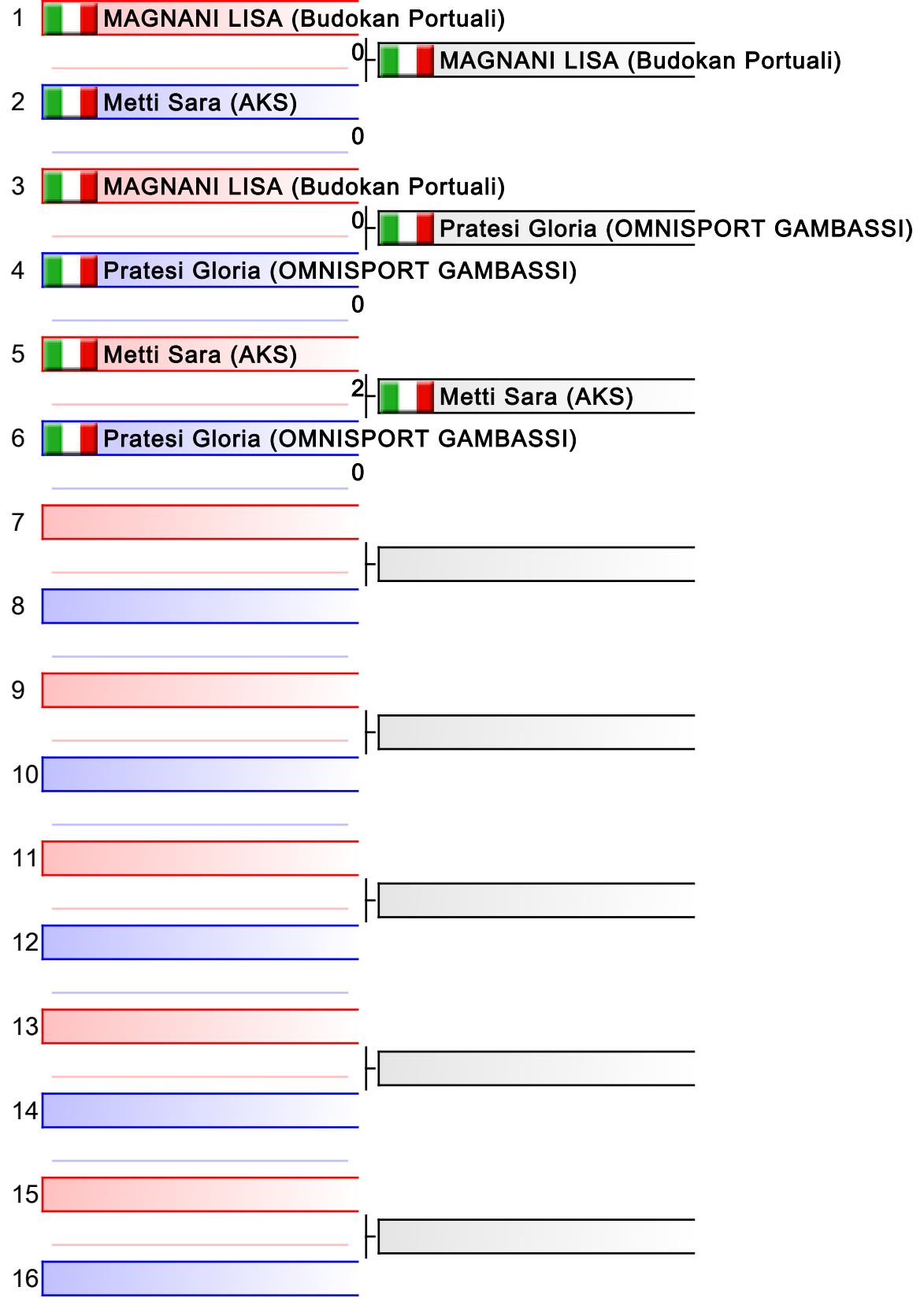

1. Metti Sara (AKS)
2. MAGNANI LISA (Budokan Portuali)
3. Pratesi Gloria (OMNISPORT GAMBASSI)

Referees:			

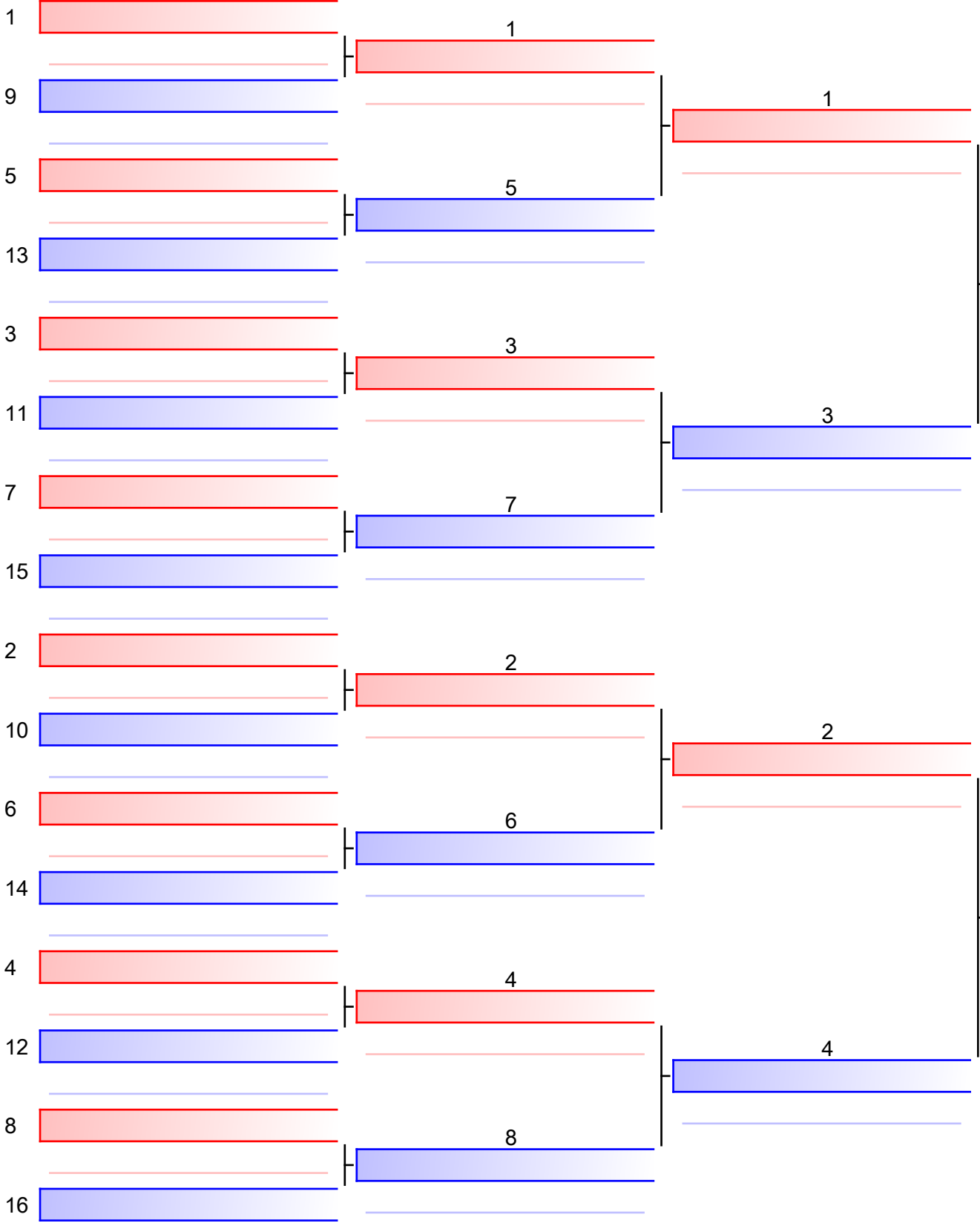

Final

Pitta Daria (Kodokan Firenze)

Fanciullo Giada (Budokan Portuali)

Pitta Daria (Kodokan Firenze)

1. Pitta Daria (Kodokan Firenze)
2. Fanciullo Giada (Budokan Portuali)

Referees:			

Kumite F SEN 45-50 Kg - Round Robin (each against each)

Trofeo Toscana Primavera

Tatami
4

Pool
1/1

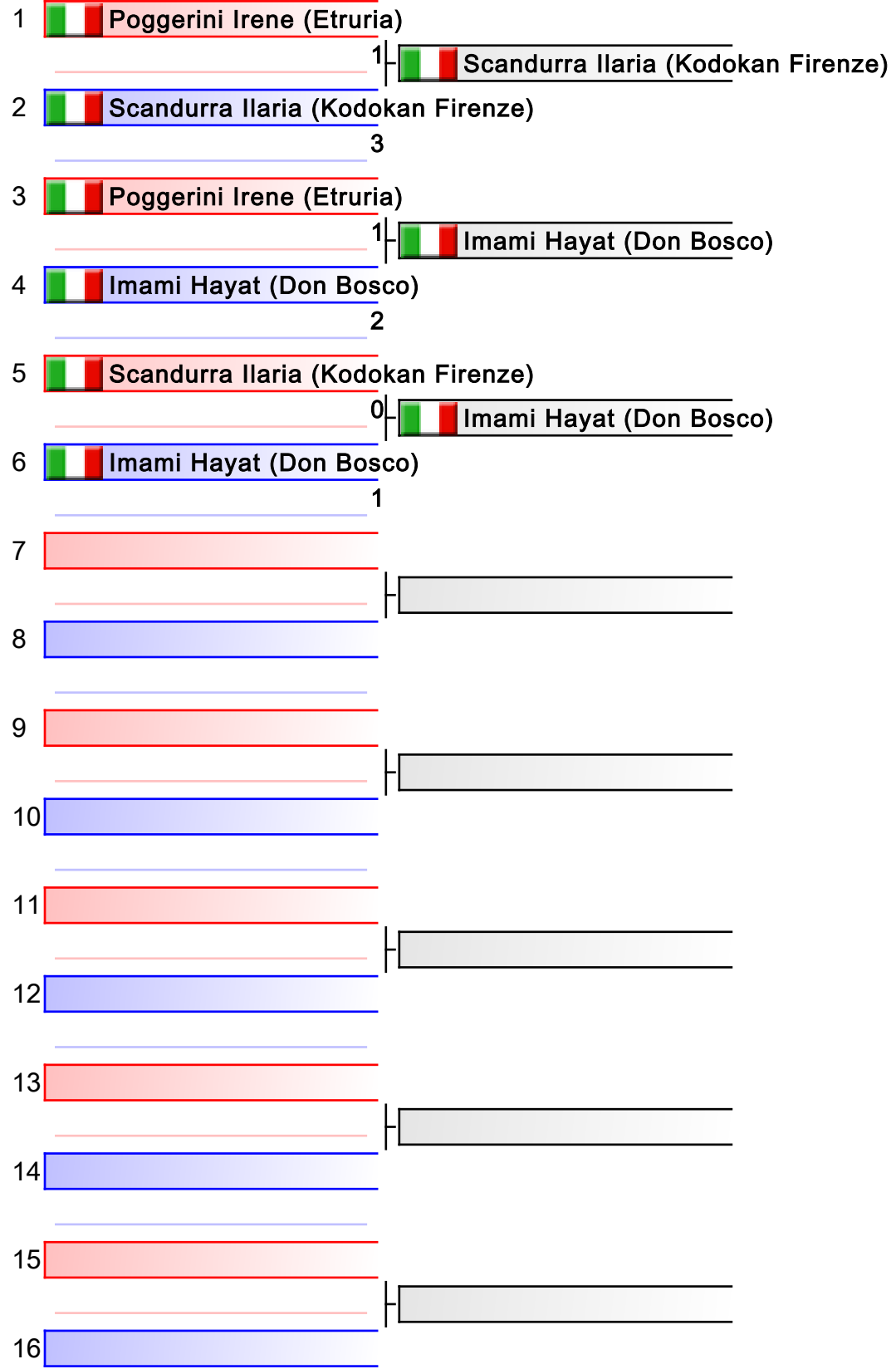

1. Imami Hayat (Don Bosco)
2. Scandurra Ilaria (Kodokan Firenze)
3. Poggerini Irene (Etruria)

Referees:			

Kumite M CAD +76 Kg - Round Robin (each against each)

Trofeo Toscana Primavera

Tatami
4

Pool
1/1

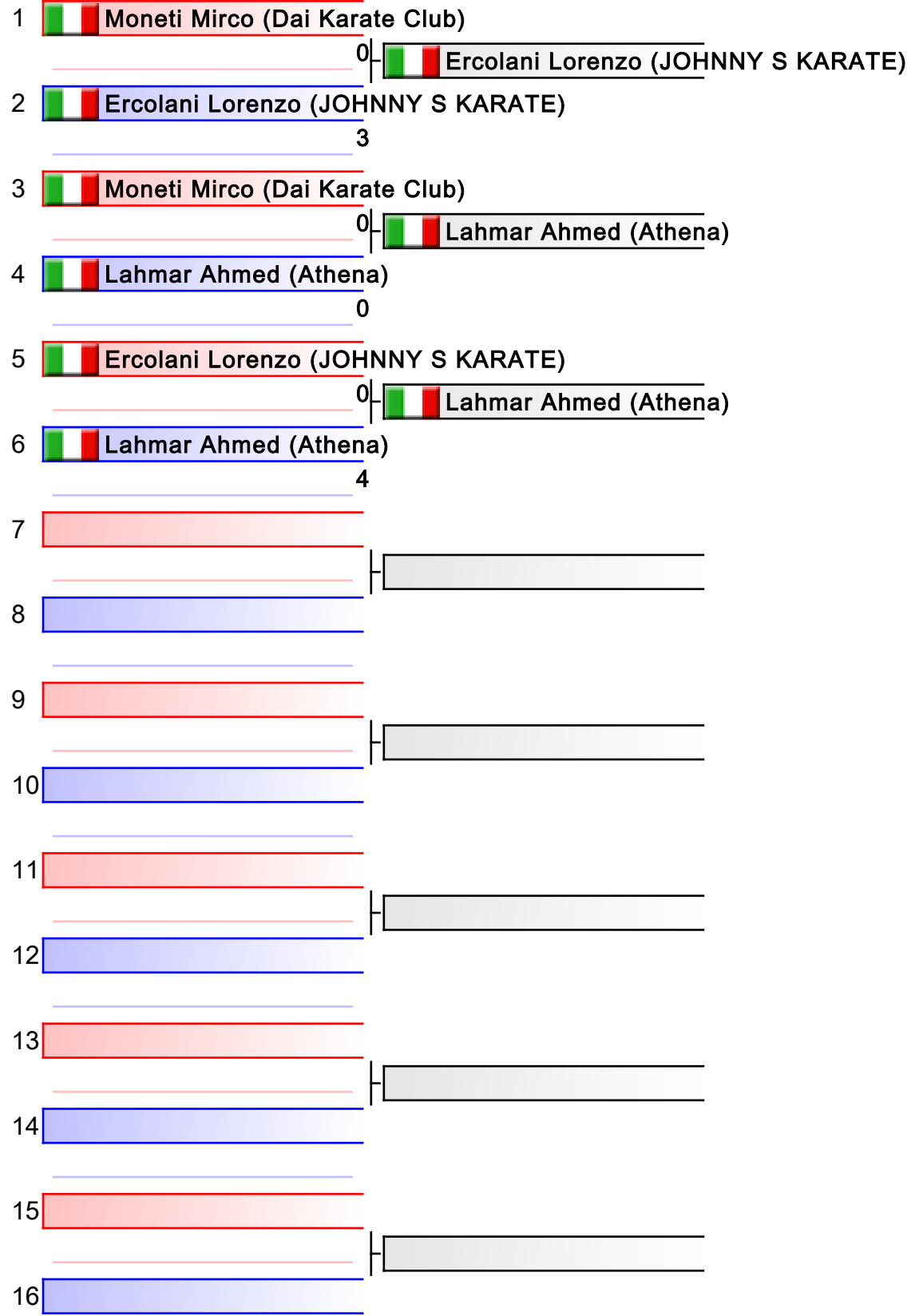

1. Lahmar Ahmed (Athena)
2. Ercolani Lorenzo (JOHNNY S KARATE)
3. Moneti Mirco (Dai Karate Club)

Referees:			

Kumite M CAD 55 Kg - Round Robin (each against each)

Trofeo Toscana Primavera

Tatami
4

Pool
1/1

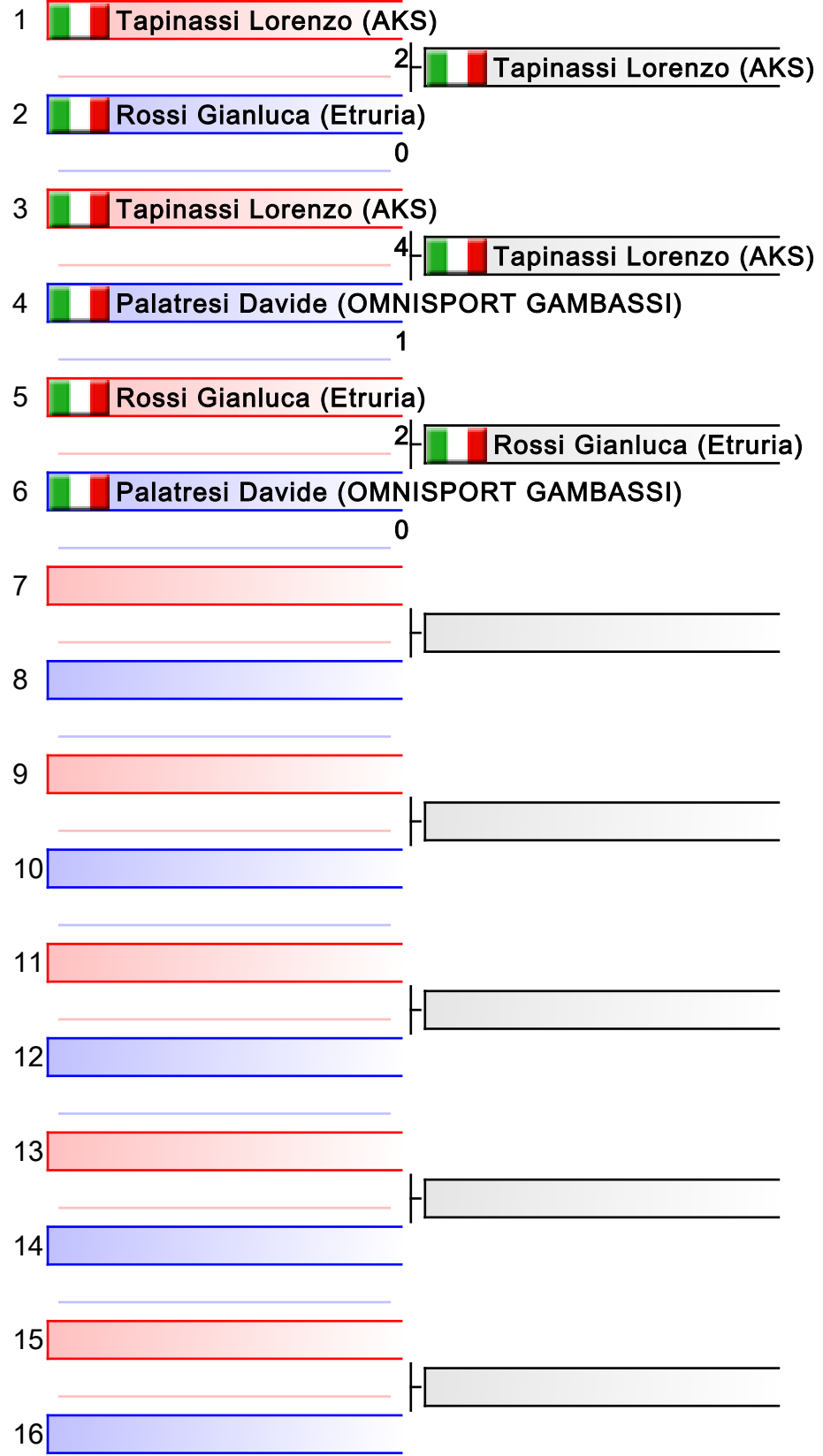

1. Tapinassi Lorenzo (AKS)
2. Rossi Gianluca (Etruria)
3. Palatresi Davide (OMNISPORT GAMBASSI)

Referees:			

Kumite M CAD 61 Kg
Trofeo Toscana Primavera

Tatami
3

Pool
1/1

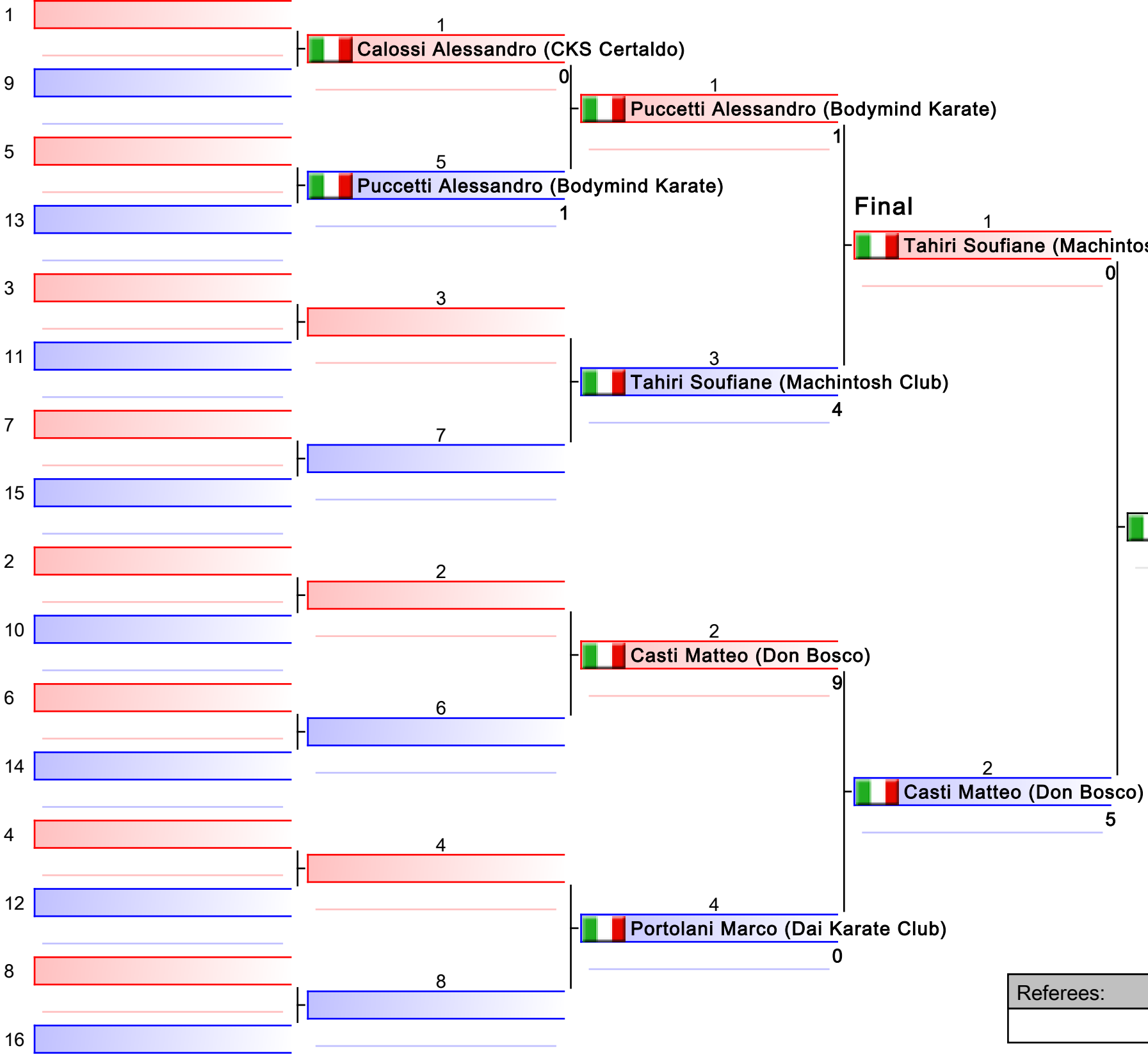

1. Casti Matteo (Don Bosco)
2. Tahiri Soufiane (Machintosh Club)
3. Puccetti Alessandro (Bodymind Karate)
3. Portolani Marco (Dai Karate Club)

Referees:			

Kumite M CAD 68 Kg
Trofeo Toscana Primavera

Tatami
2

Pool
1/1

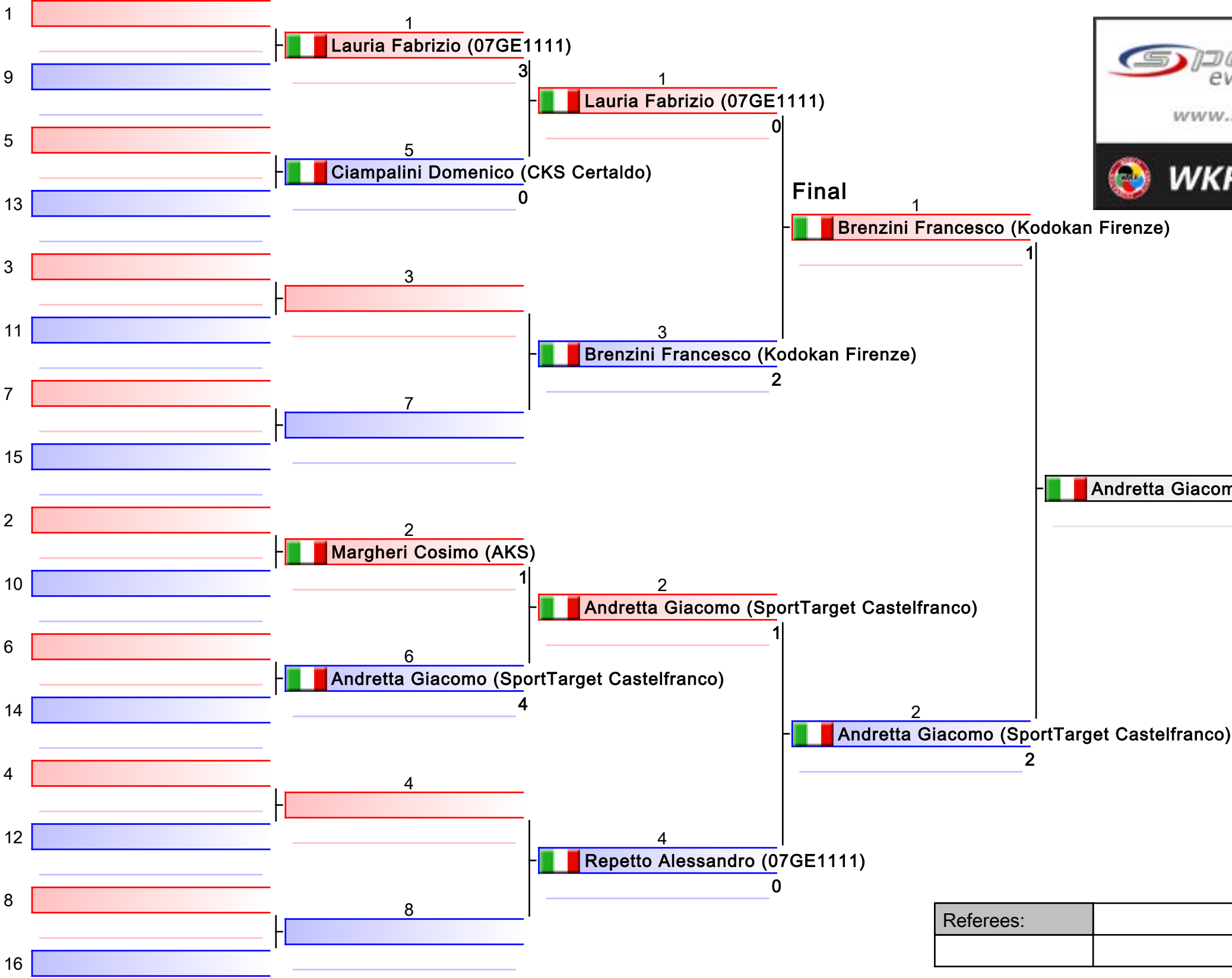

1. Andretta Giacomo (SportTarget Castelfranco)
2. Brenzini Francesco (Kodokan Firenze)
3. Lauria Fabrizio (07GE1111)
3. Margheri Cosimo (AKS)
5. Repetto Alessandro (07GE1111)

Referees:			

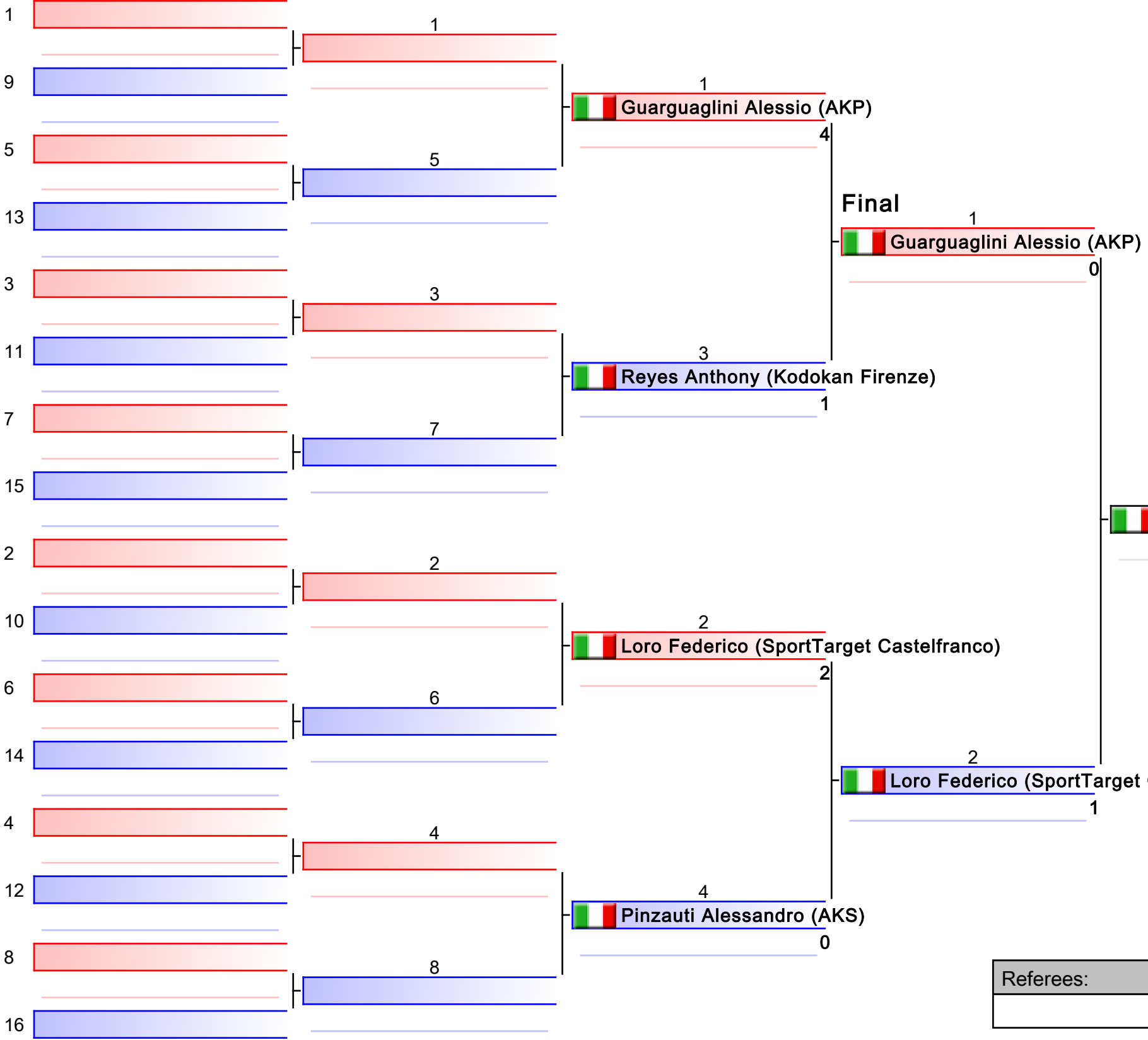

1. Loro Federico (SportTarget Castelfranco)
2. Guarguaglini Alessio (AKP)
3. Reyes Anthony (Kodokan Firenze)
3. Pinzauti Alessandro (AKS)

Referees:			

Kumite M Es.A 35-40 Kg

Trofeo Toscana Primavera

Tatami
4

Pool
1/1

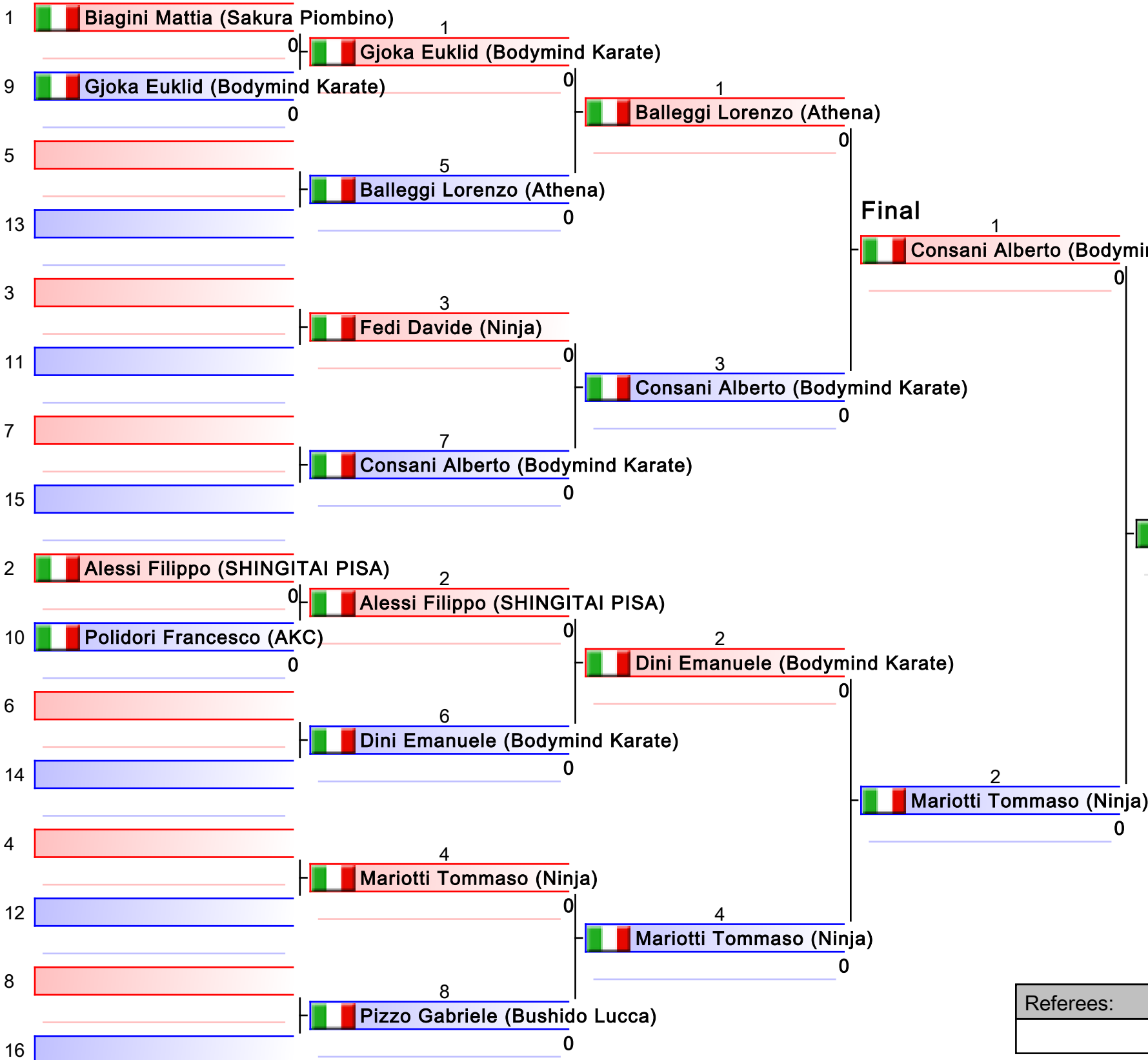

1. Mariotti Tommaso (Ninja)
2. Consani Alberto (Bodymind Karate)
3. Balleggi Lorenzo (Athena)
3. Dini Emanuele (Bodymind Karate)
5. Fedi Davide (Ninja)
5. Pizzo Gabriele (Bushido Lucca)

Referees:			

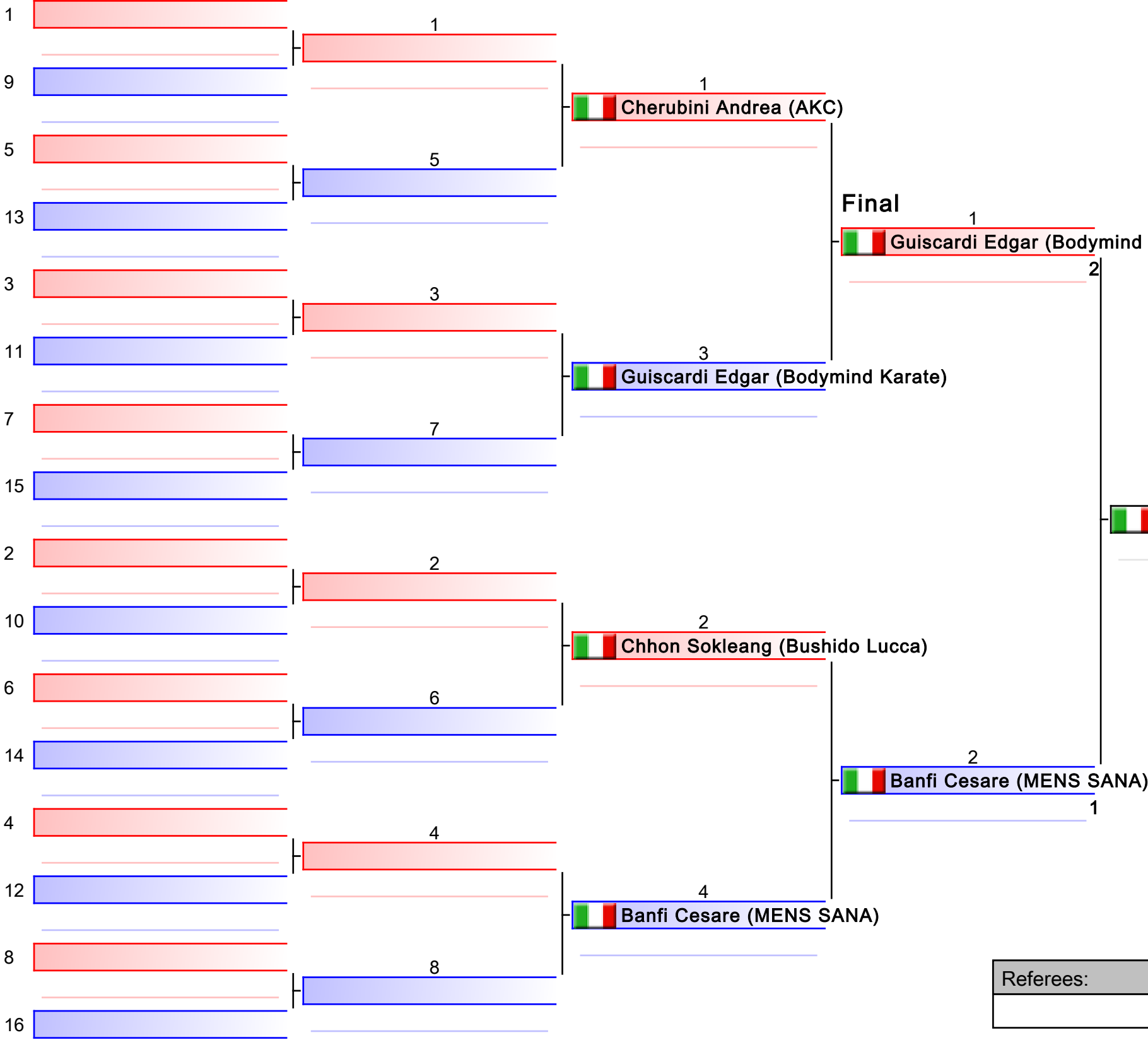

Final

1. Guiscardi Edgar (Bodymind Karate)
2. Banfi Cesare (MENS SANA)
3. Cherubini Andrea (AKC)
3. Chhon Sokleang (Bushido Lucca)

Referees:			

Kumite M Es.A 50 Kg
Trofeo Toscana Primavera

Tatami
3

Pool
1/1

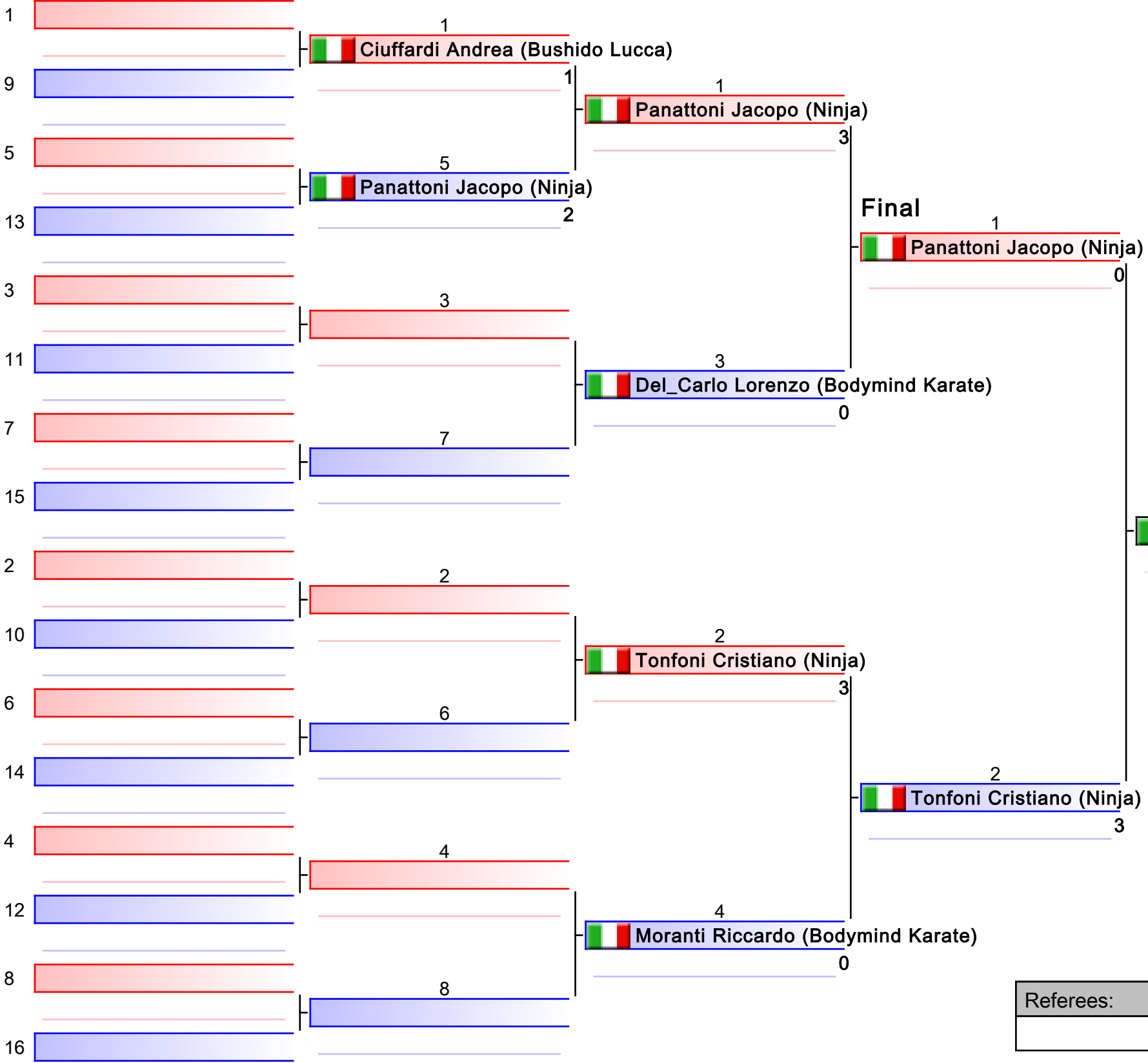

Tonfoni Cristiano (Ninja)

1. Tonfoni Cristiano (Ninja)
2. Panattoni Jacopo (Ninja)
3. Moranti Riccardo (Bodymind Karate)
3. Ciuffardi Andrea (Bushido Lucca)
5. Del_Carlo Lorenzo (Bodymind Karate)

Referees:			

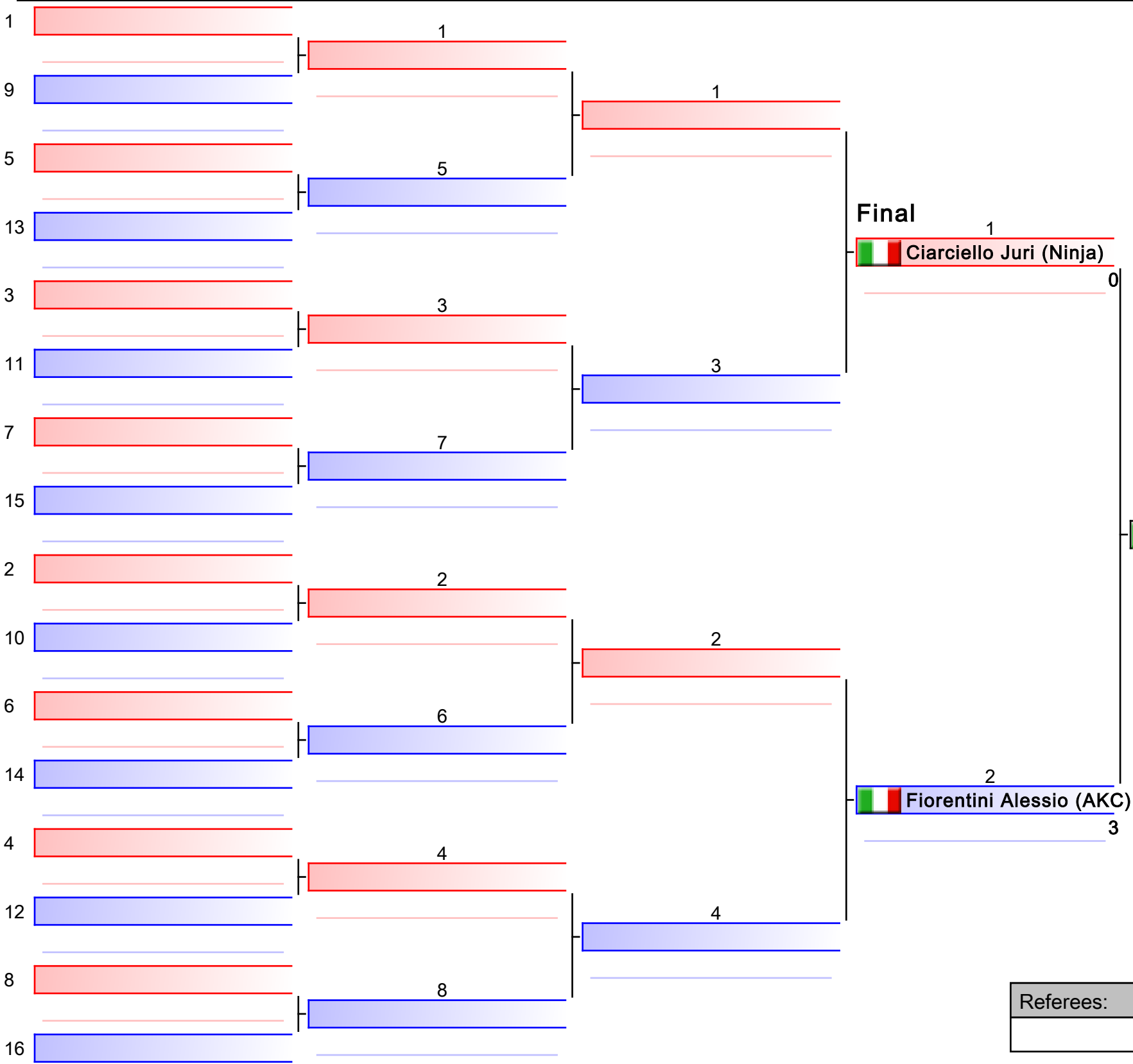

Fiorentini Alessio (AKC)

1. Fiorentini Alessio (AKC)
2. Ciarcello Juri (Ninja)

Referees:			

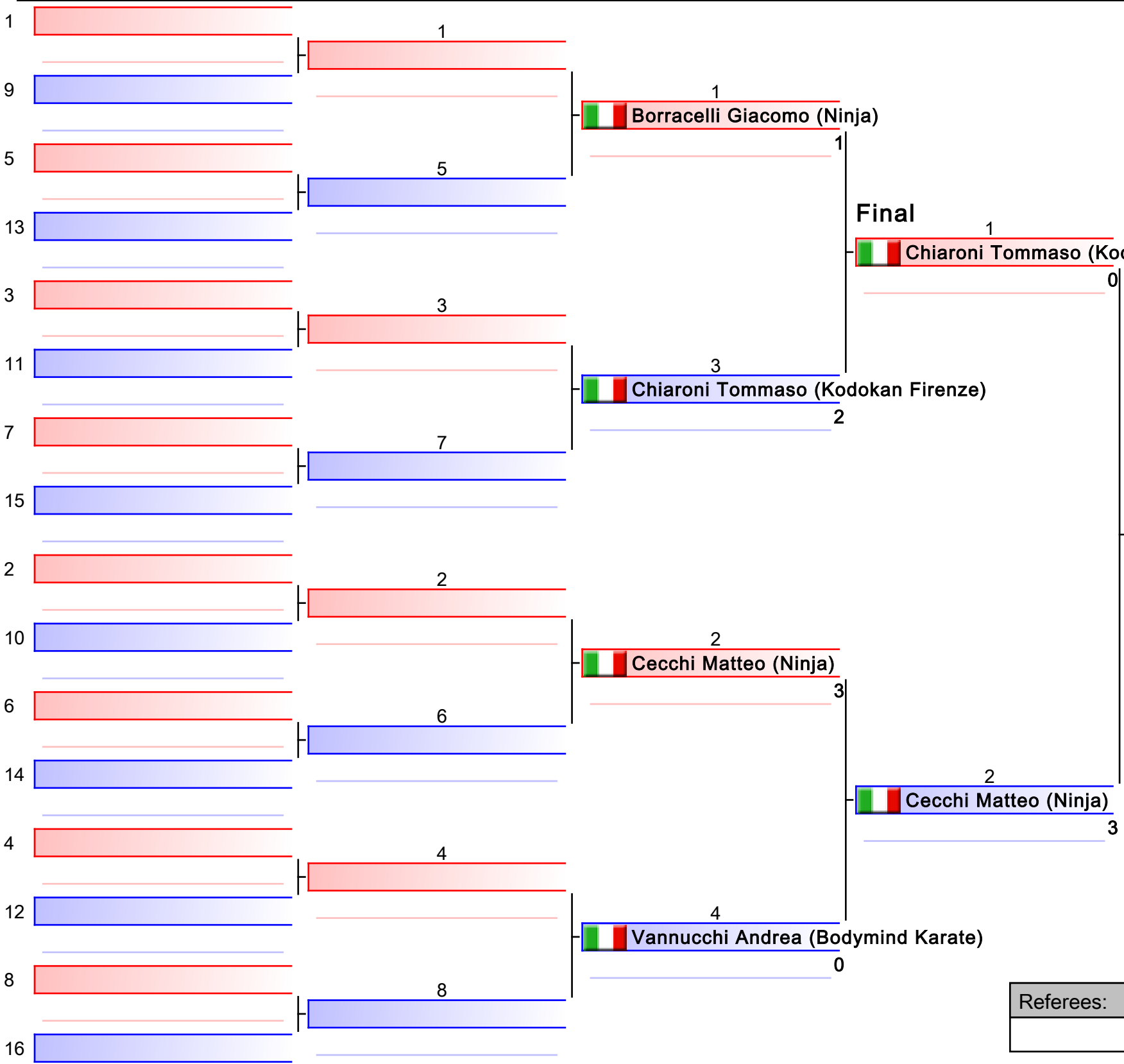

Final

1. Cecchi Matteo (Ninja)
2. Chiaroni Tommaso (Kodokan Firenze)
3. Borracelli Giacomo (Ninja)
3. Vannucchi Andrea (Bodymind Karate)

Referees:			

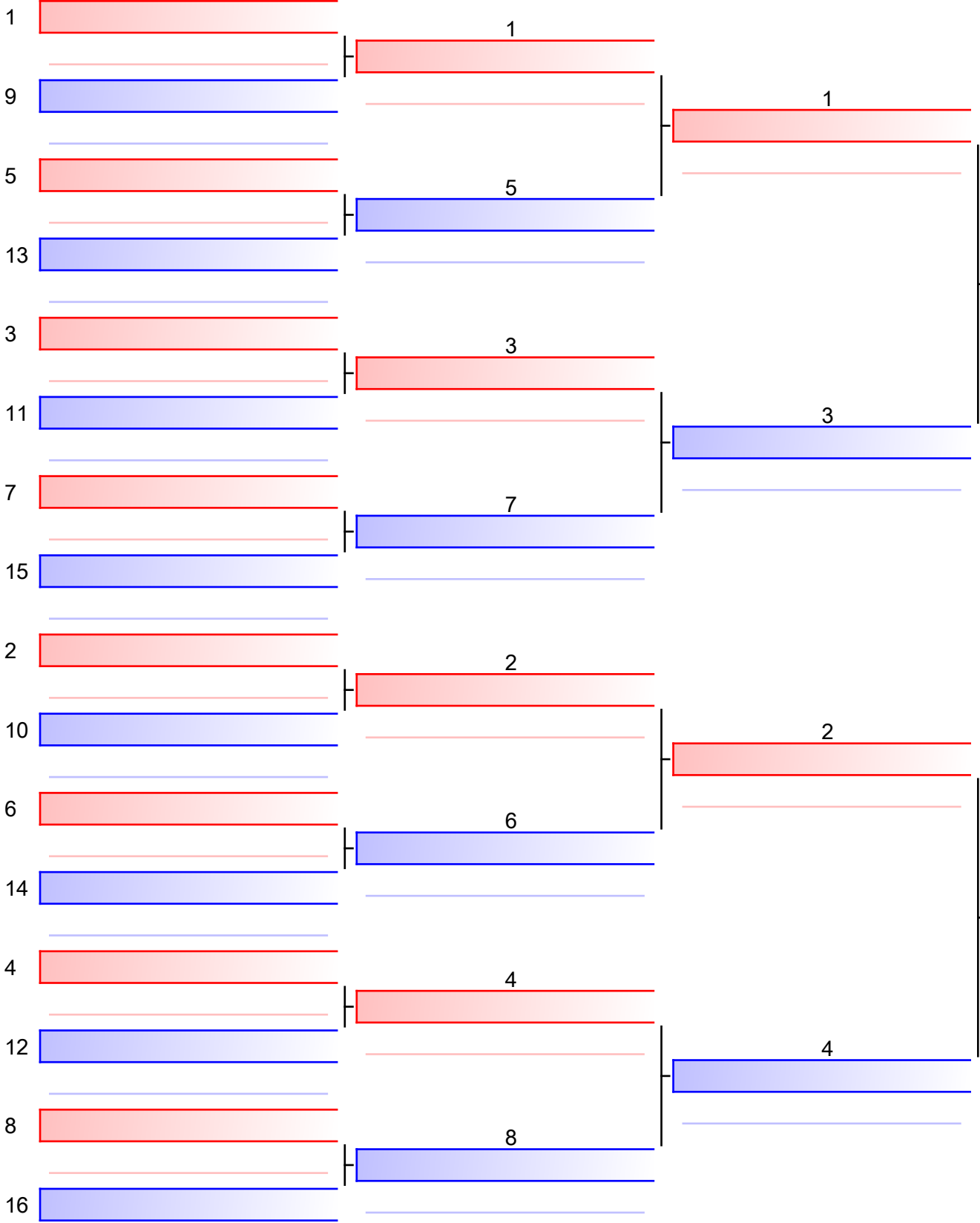

Final

Valori Matteo (CKS Certaldo)

1
0

Andretta Davide (SportTarget Castelfranco)

Andretta Davide (SportTarget Castelfranco)

2
5

1. Andretta Davide (SportTarget Castelfranco)
2. Valori Matteo (CKS Certaldo)

Referees:			

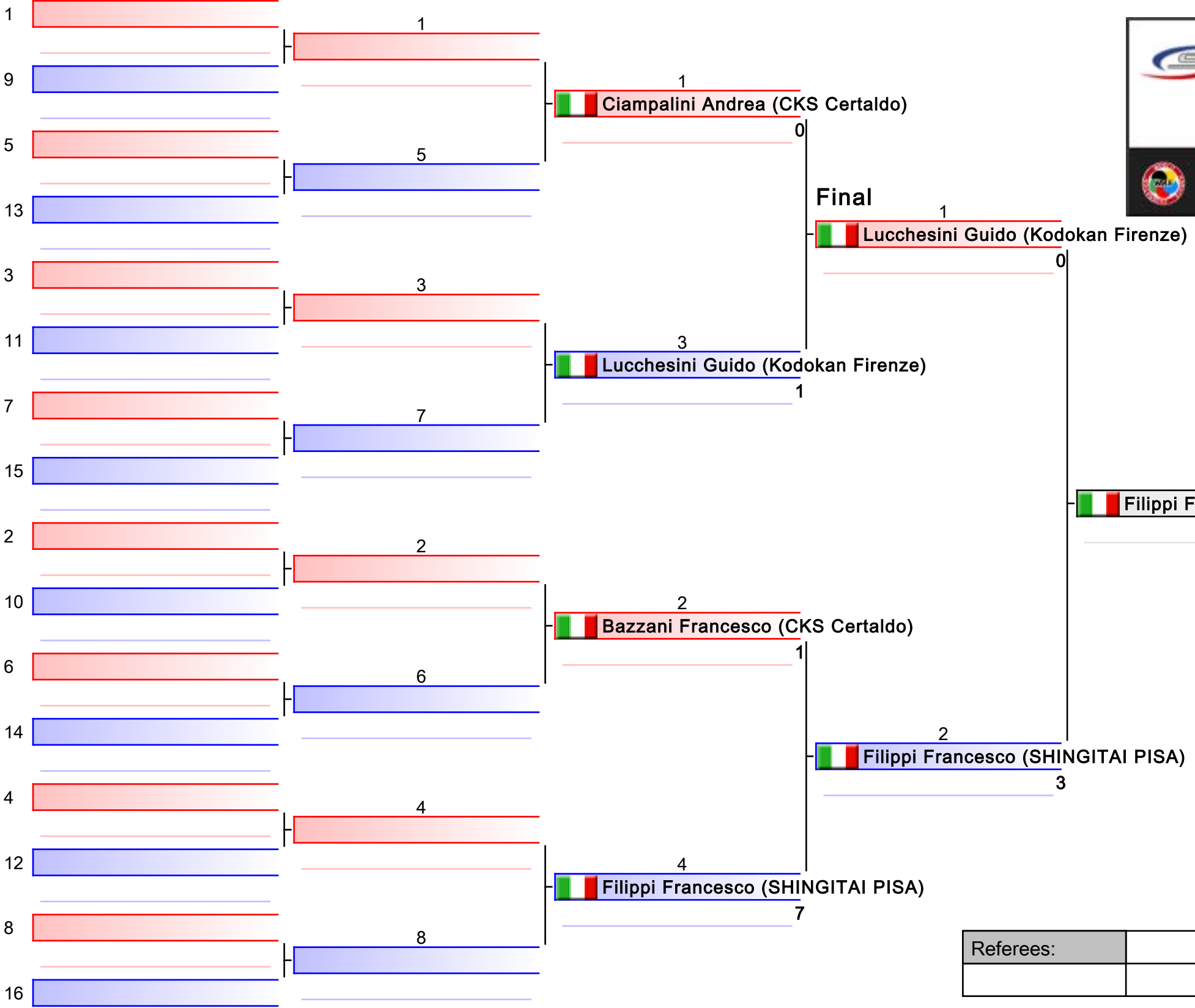

1. Filippi Francesco (SHINGITAI PISA)
2. Lucchesini Guido (Kodokan Firenze)
3. Ciampalini Andrea (CKS Certaldo)
3. Bazzani Francesco (CKS Certaldo)

Referees:			

Kumite M Es.B 63 Kg - Round Robin (each against each)

Trofeo Toscana Primavera

Tatami
2

Pool
1/1

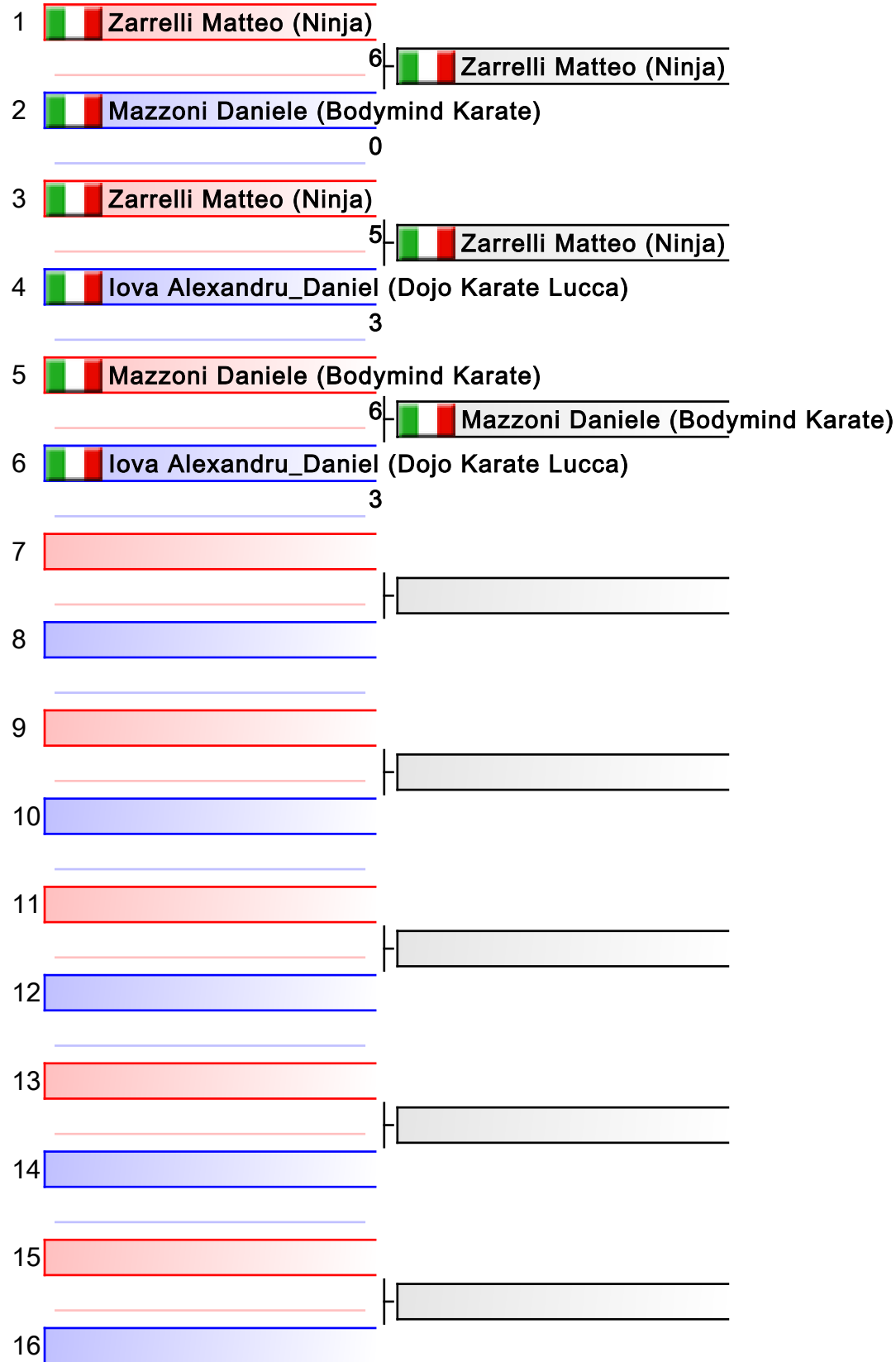

1. Zarrelli Matteo (Ninja)
2. Mazzoni Daniele (Bodymind Karate)
3. Iova Alexandru_Daniel (Dojo Karate Lucca)

Referees:			

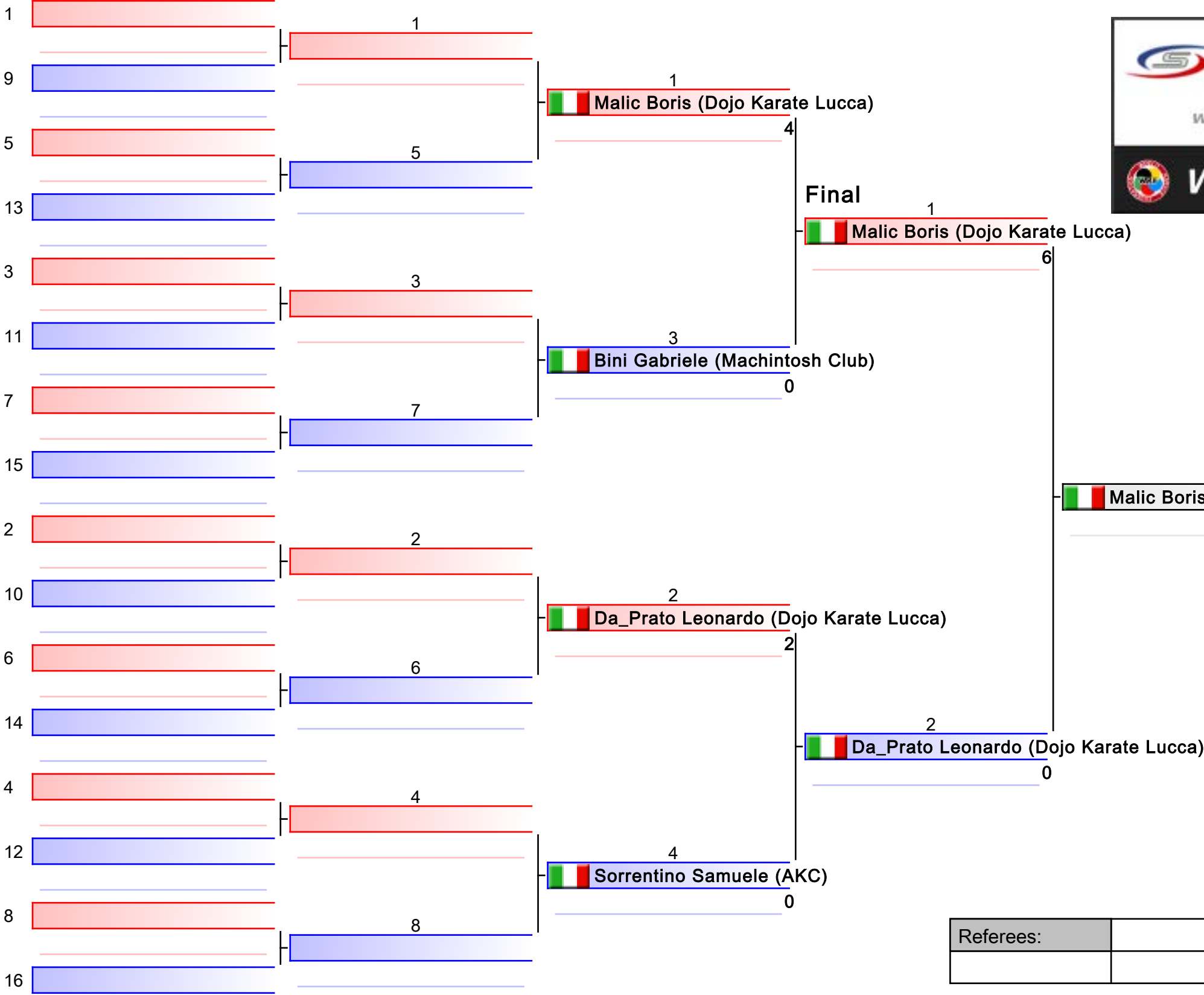

1. Malic Boris (Dojo Karate Lucca)
2. Da_Prato Leonardo (Dojo Karate Lucca)
3. Bini Gabriele (Machintosh Club)
3. Sorrentino Samuele (AKC)

Referees:			

Kumite M Es.B 78 Kg - Round Robin (each against each)

Trofeo Toscana Primavera

Tatami
2

Pool
1/1

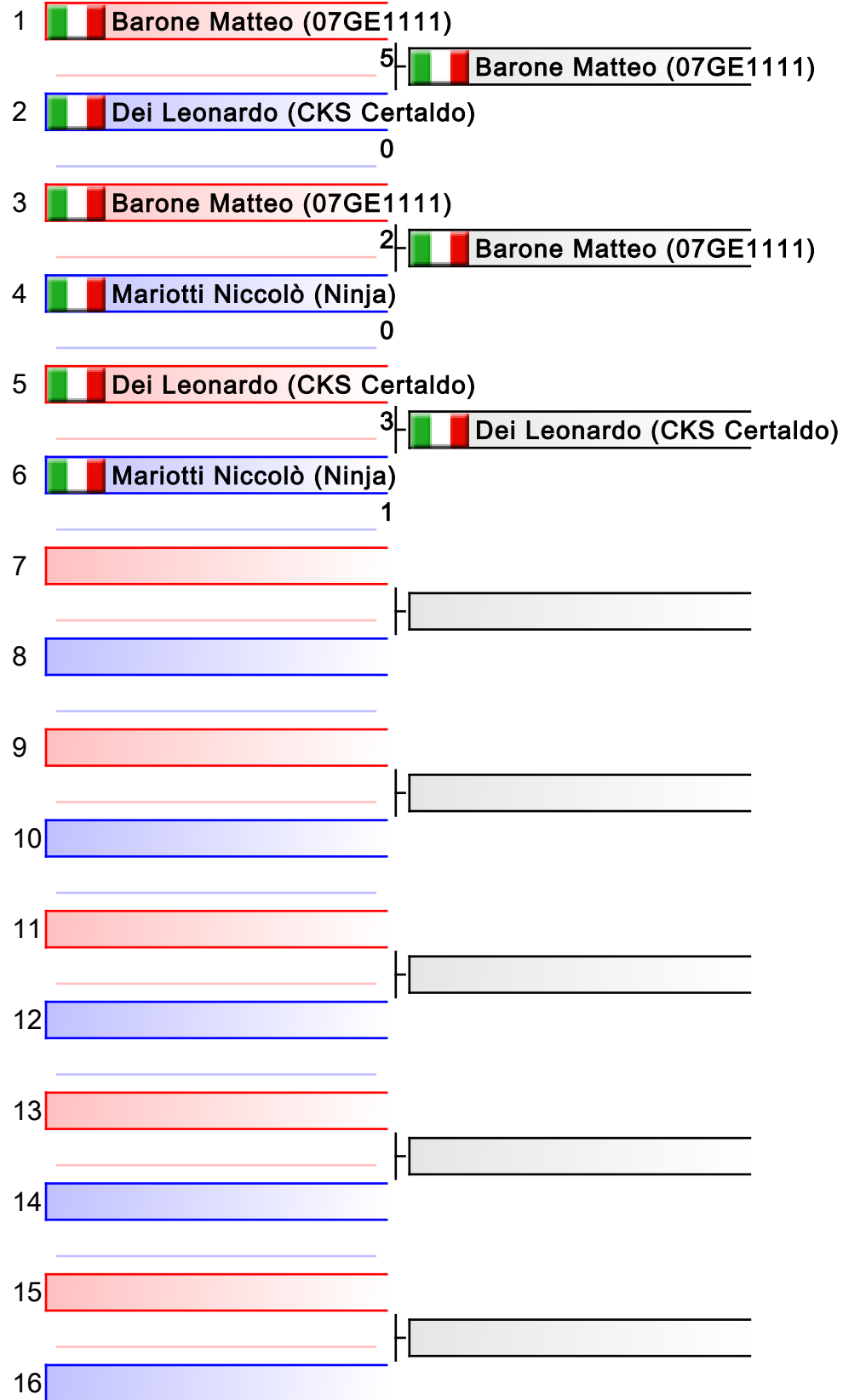

1. Barone Matteo (07GE1111)
2. Dei Leonardo (CKS Certaldo)
3. Mariotti Niccolò (Ninja)

Referees:			

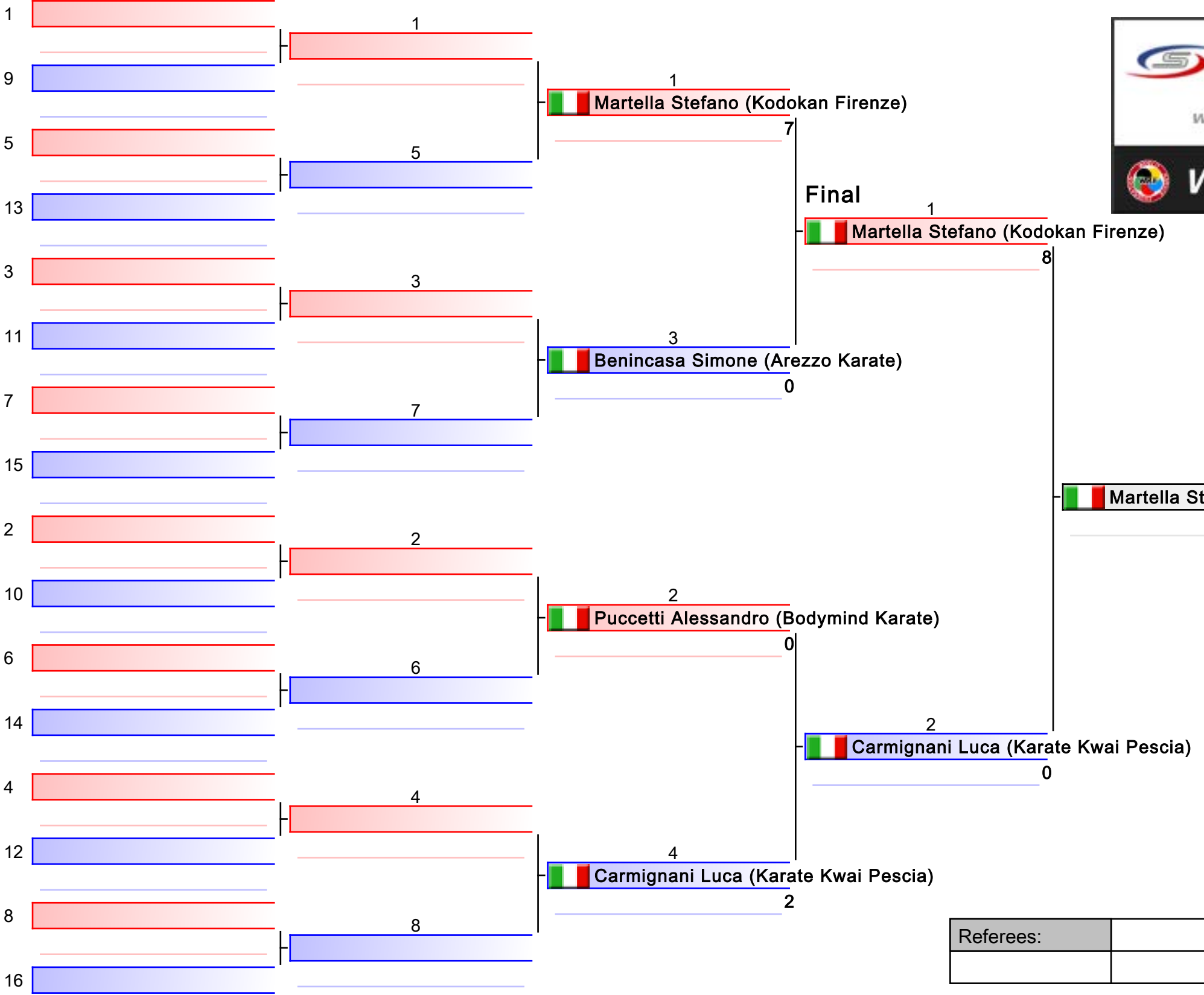

1. Martella Stefano (Kodokan Firenze)
2. Carmignani Luca (Karate Kwai Pescia)
3. Benincasa Simone (Arezzo Karate)
3. Puccetti Alessandro (Bodymind Karate)

Referees:			

Kumite M JUN -67 Kg - Round Robin (each against each)

Trofeo Toscana Primavera

Tatami
3

Pool
1/1

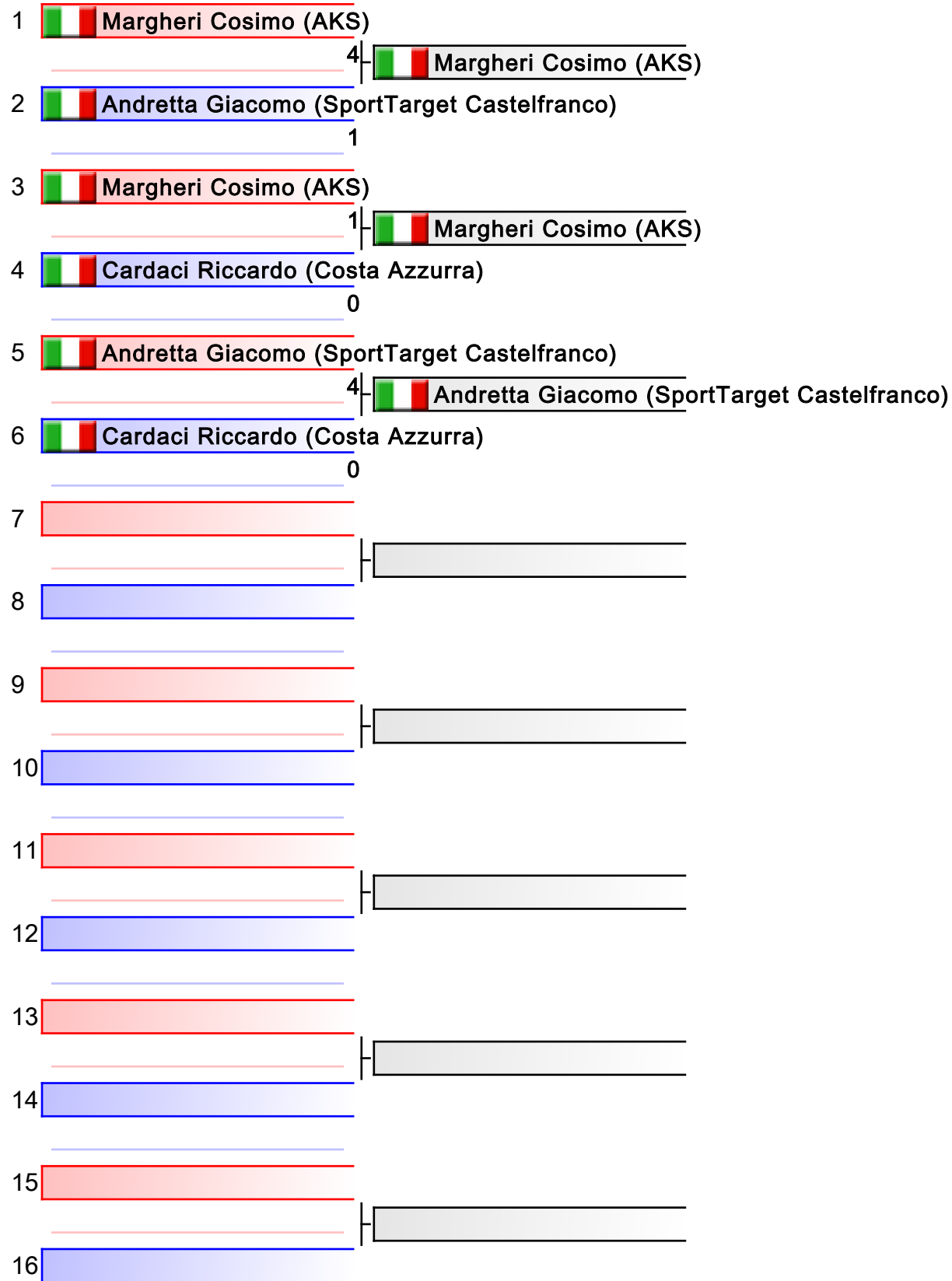

1. Margheri Cosimo (AKS)
2. Andretta Giacomo (SportTarget Castelfranco)
3. Cardaci Riccardo (Costa Azzurra)

Referees:			

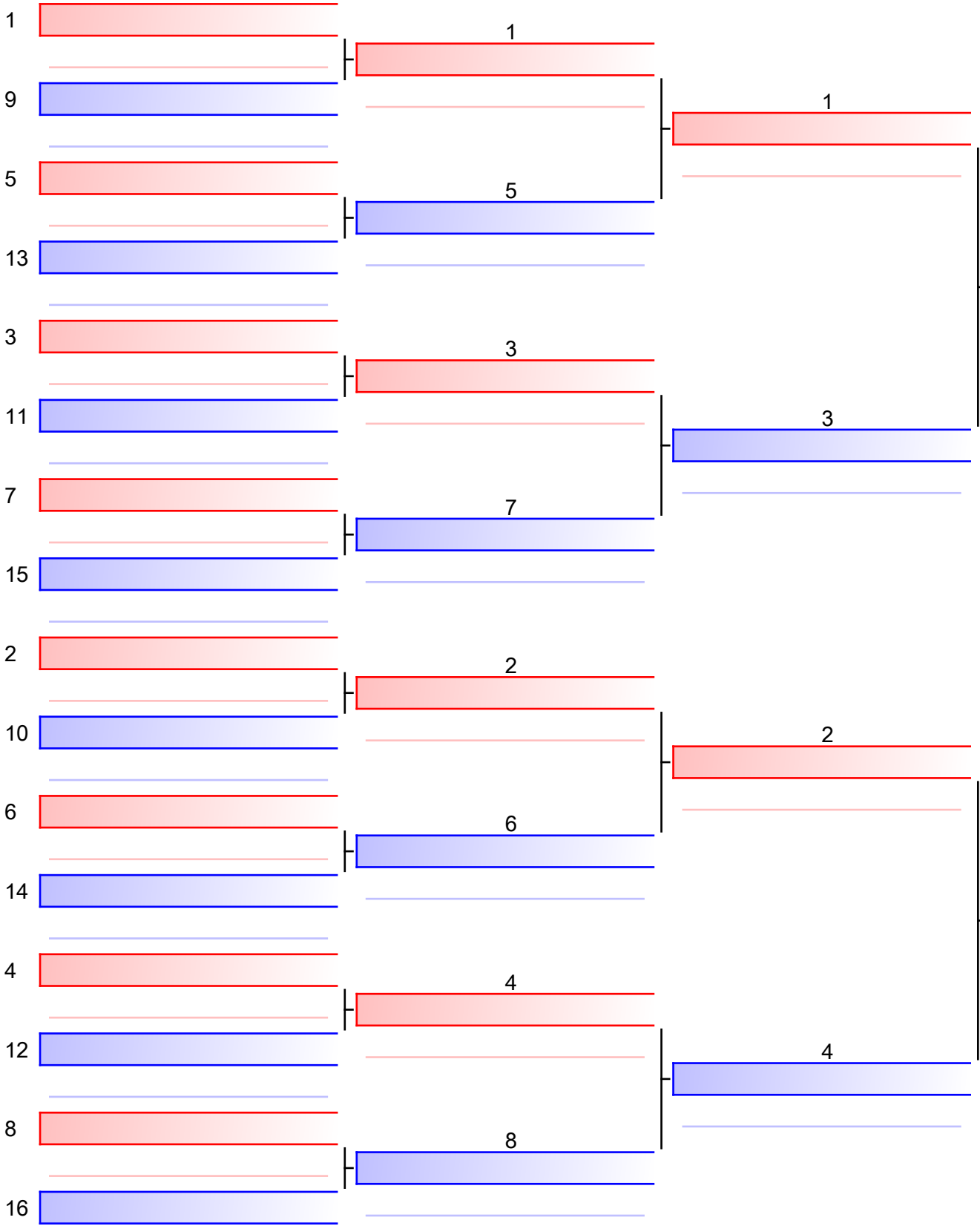

Final

1
ROSSELLI_DEL_TURCO RICCARDO (SHINGITAI PISA)
 0

2
Spagli Lorenzo (Kodokan Firenze)

2
Spagli Lorenzo (Kodokan Firenze)
 4

1. Spagli Lorenzo (Kodokan Firenze)
2. ROSSELLI_DEL_TURCO RICCARDO (SHINGITAI PISA)

Referees:			

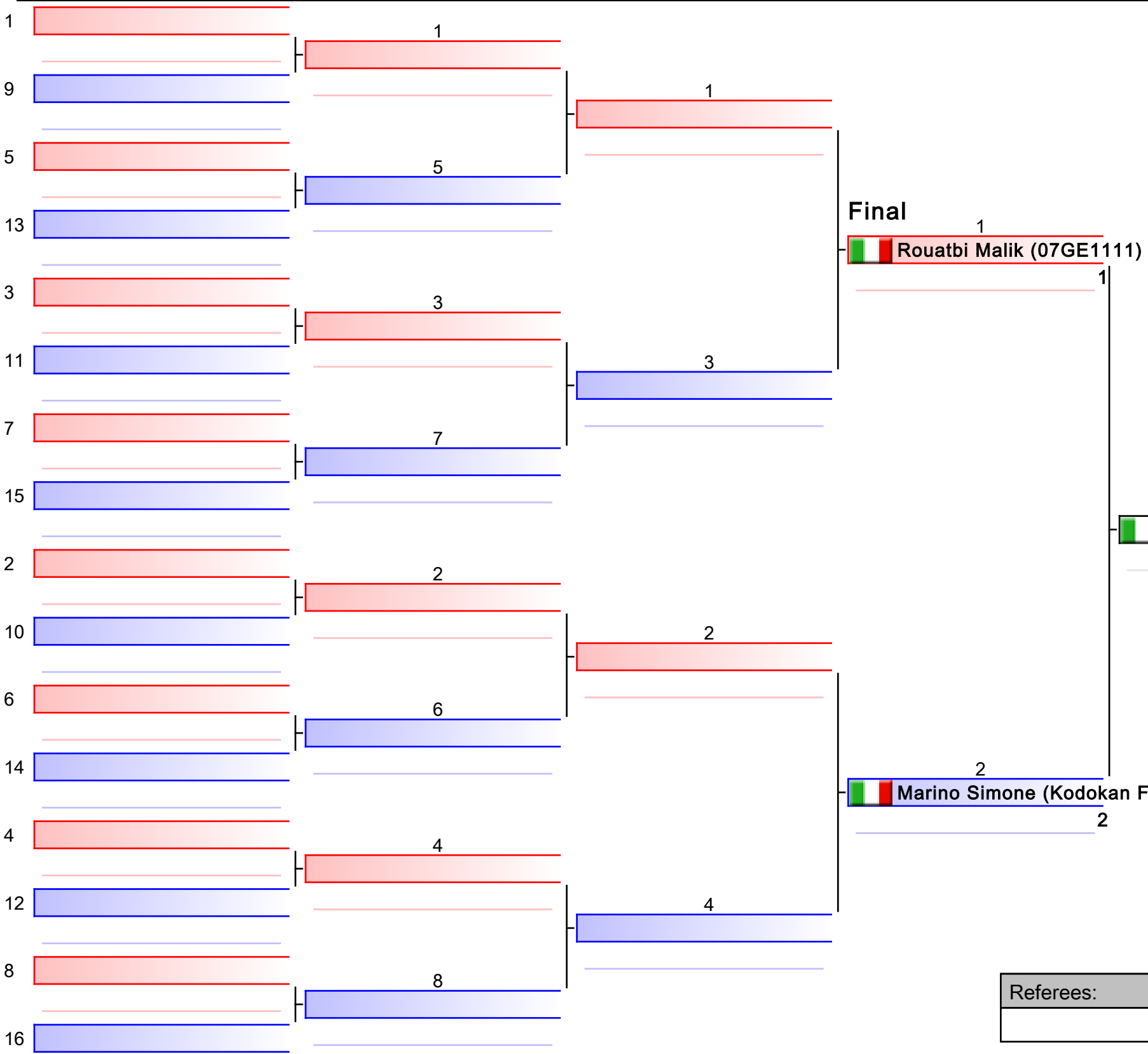

1. Marino Simone (Kodokan Firenze)
2. Rouatbi Malik (07GE1111)

Referees:			

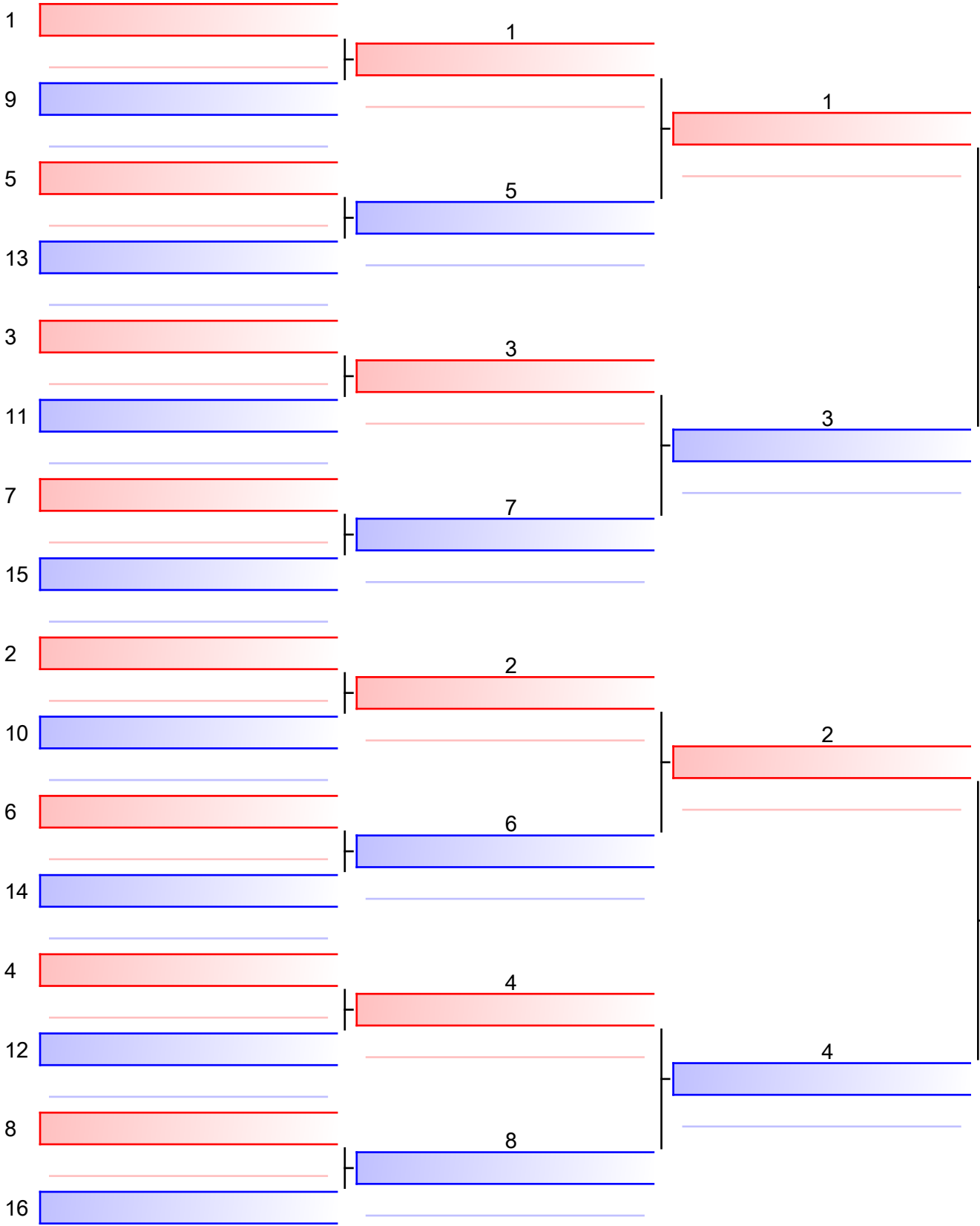

Final

1
CATURELLI ANTONIO (SKF)

0

1
CATURELLI ANTONIO (SKF)

2
Braggion Devis (Shotokan Cavarzere)

0

1. CATURELLI ANTONIO (SKF)
2. Braggion Devis (Shotokan Cavarzere)

Referees:			

Kumite M MAS35 84Kg - Round Robin (each against each)

Trofeo Toscana Primavera

Tatami
1

Pool
1/1

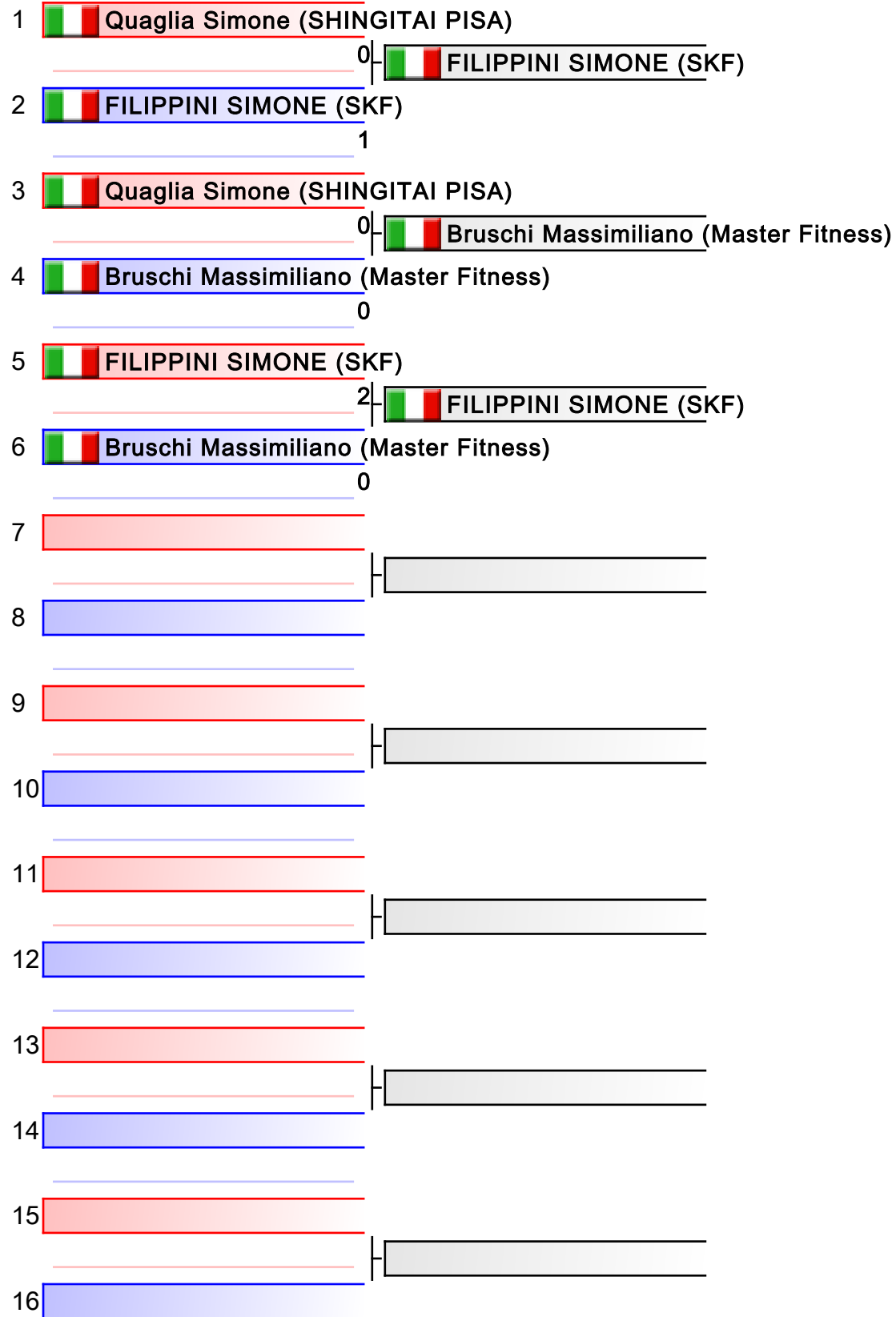

1. FILIPPINI SIMONE (SKF)
2. Bruschi Massimiliano (Master Fitness)
3. Quaglia Simone (SHINGITAI PISA)

Referees:			

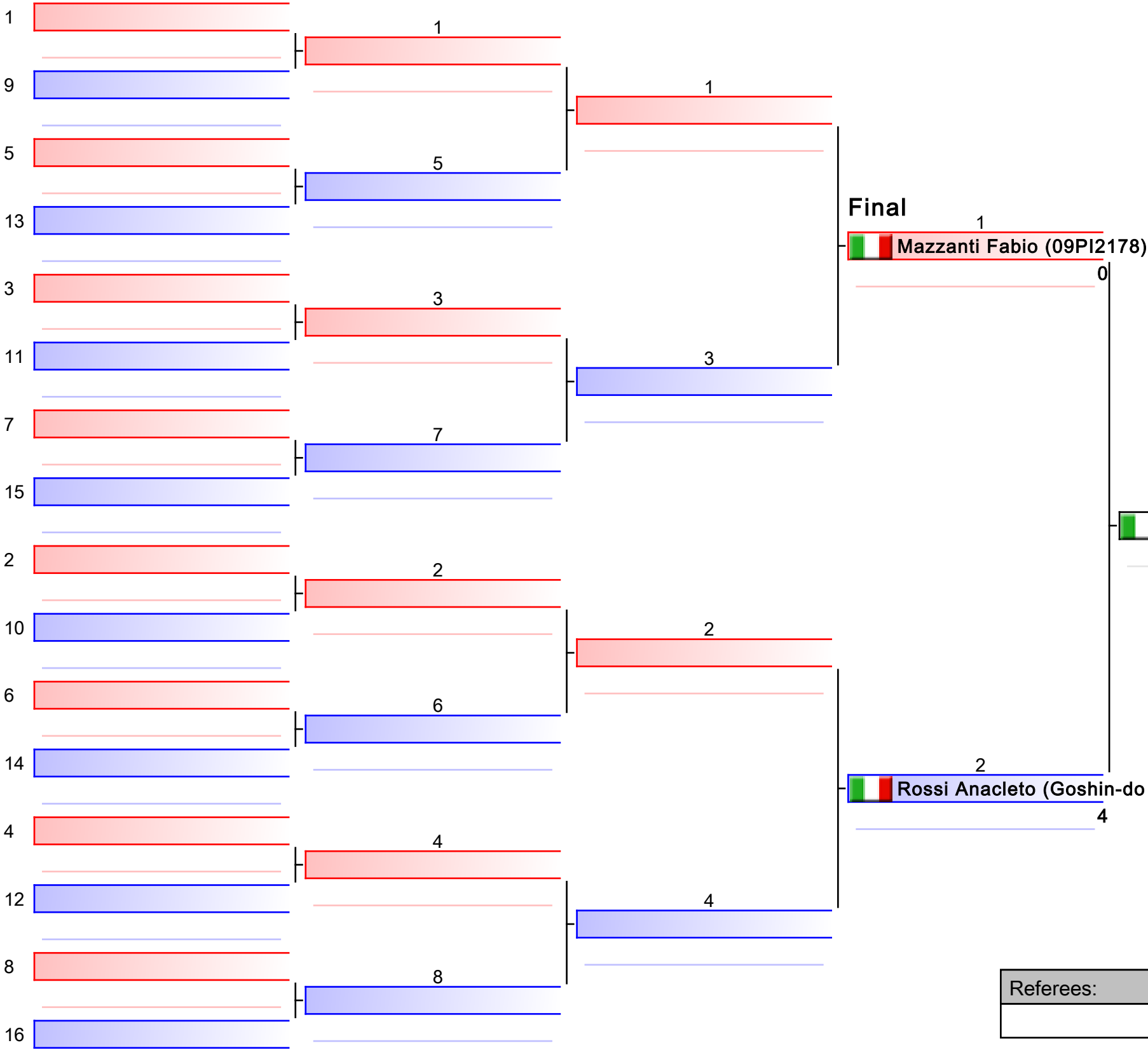

1. Rossi Anacleto (Goshin-do Barga)
2. Mazzanti Fabio (09PI2178)

Referees:			

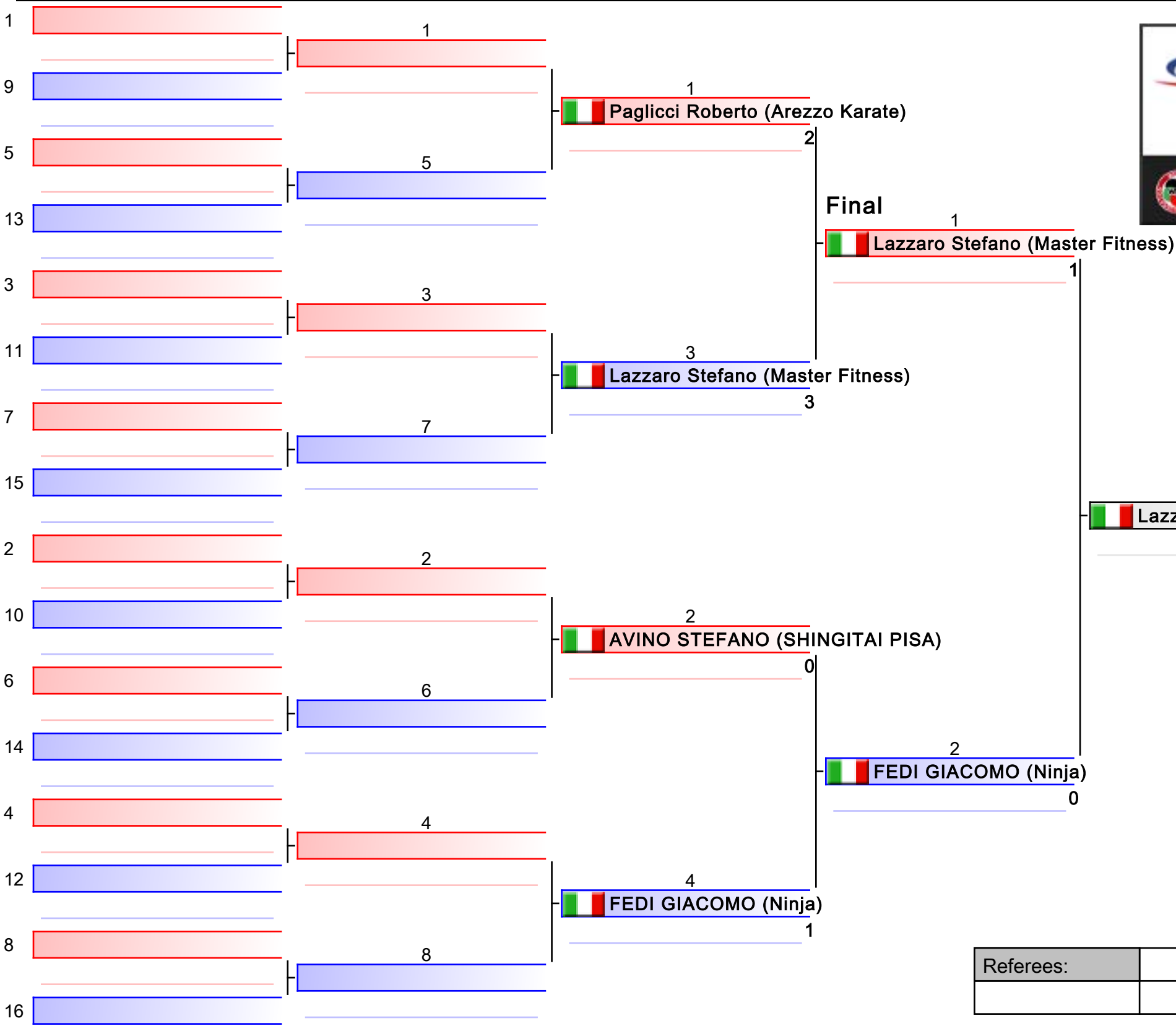

Lazzaro Stefano (Master Fitness)

1. Lazzaro Stefano (Master Fitness)
2. FEDI GIACOMO (Ninja)
3. Paglicci Roberto (Arezzo Karate)
3. AVINO STEFANO (SHINGITAI PISA)

Referees:			

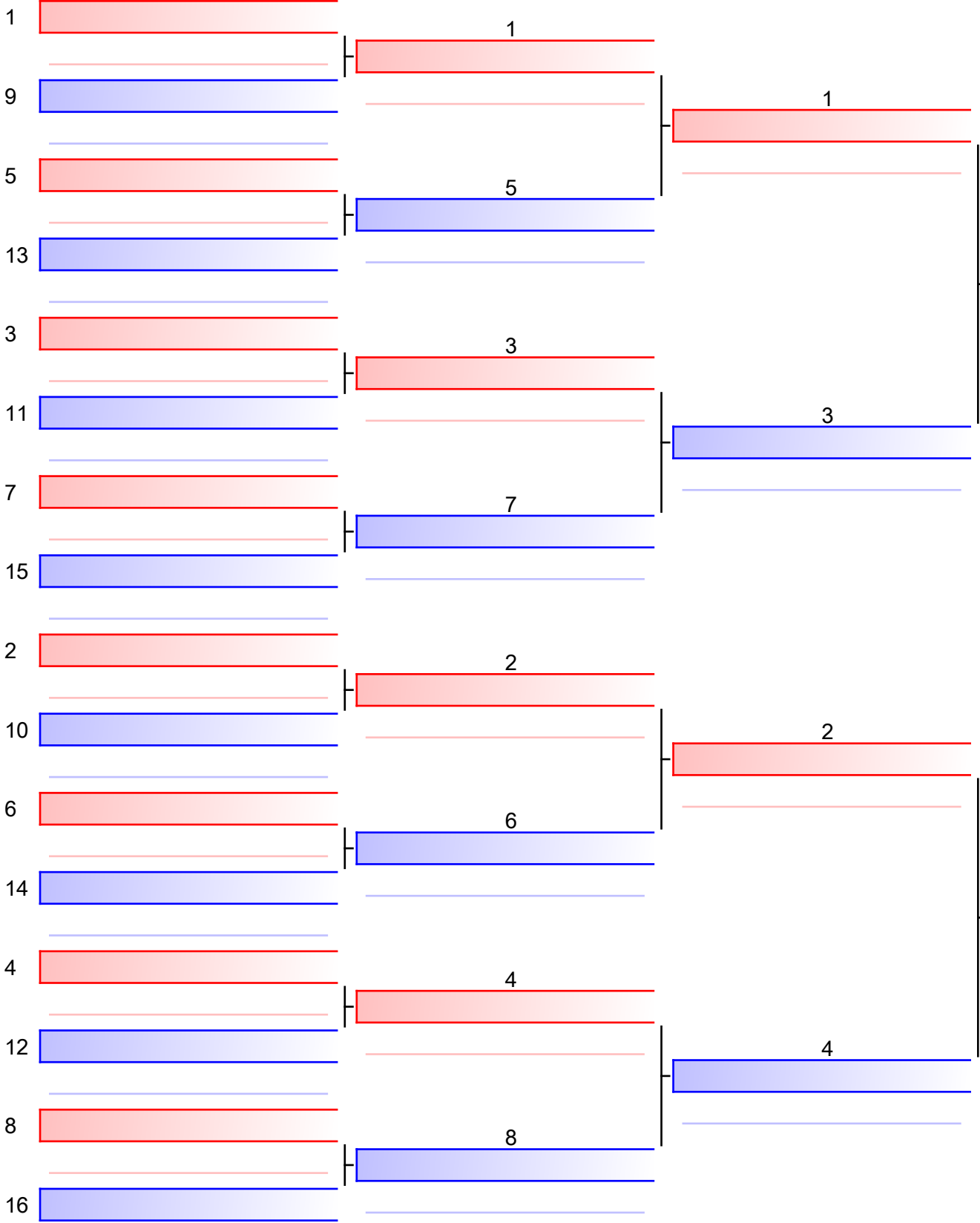

Final

ZIGLIOLI VALTER (PANARO MODENA)

Orsi Lanfranco (Goshin-do Barga)

1. Orsi Lanfranco (Goshin-do Barga)

Referees:			

Kumite M SEN -67 Kg
Trofeo Toscana Primavera

Tatami
1

Pool
1/1

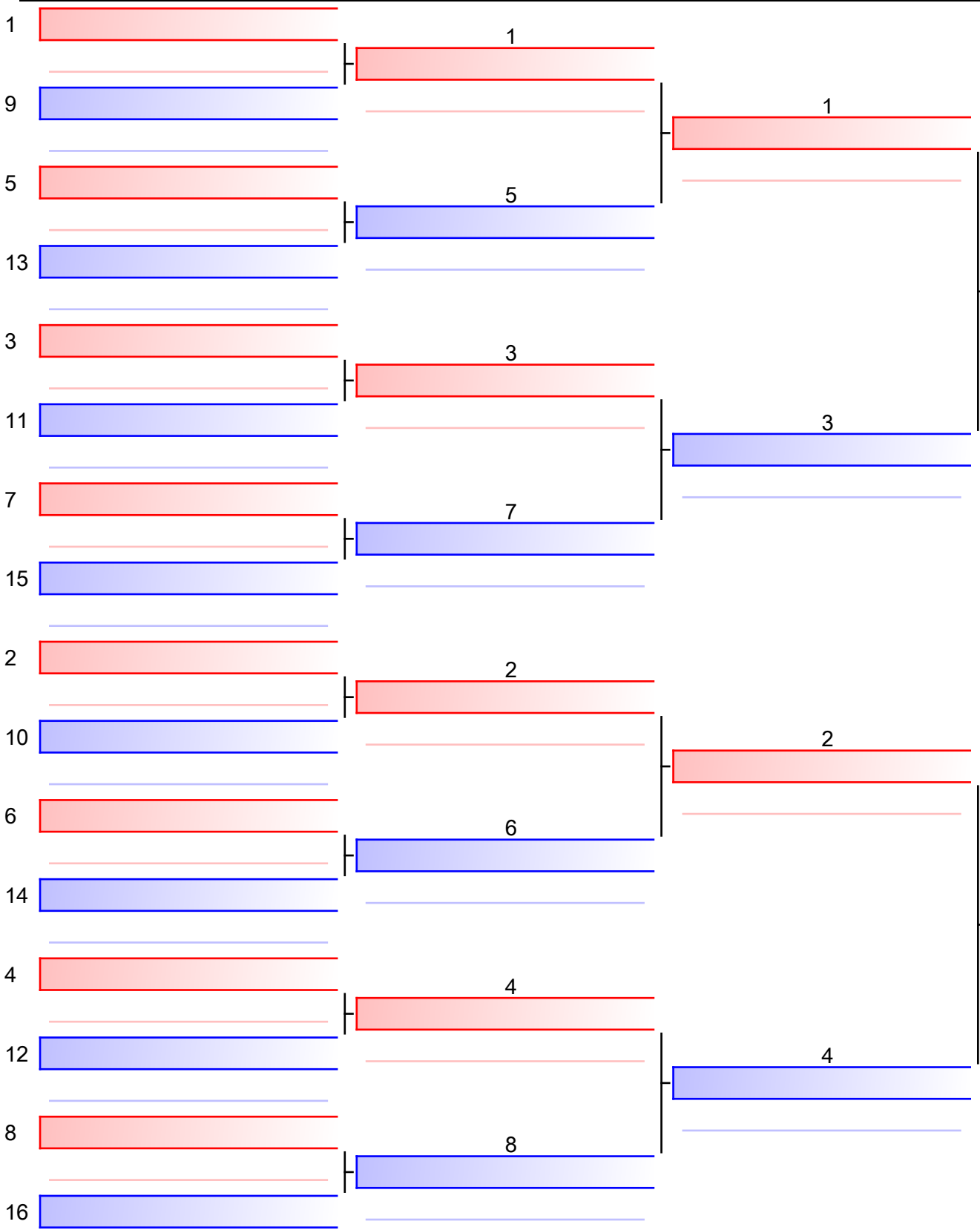

Final

1
Puleo Gabriele (Kodokan Firenze)

10

2
Puleo Gabriele (Kodokan Firenze)

2
CHITI MAXIM (09PI2178)

0

1. Puleo Gabriele (Kodokan Firenze)
2. CHITI MAXIM (09PI2178)

Referees:			

Kumite M SEN -75 Kg - Round Robin (each against each)

Trofeo Toscana Primavera

Tatami
1

Pool
1/1

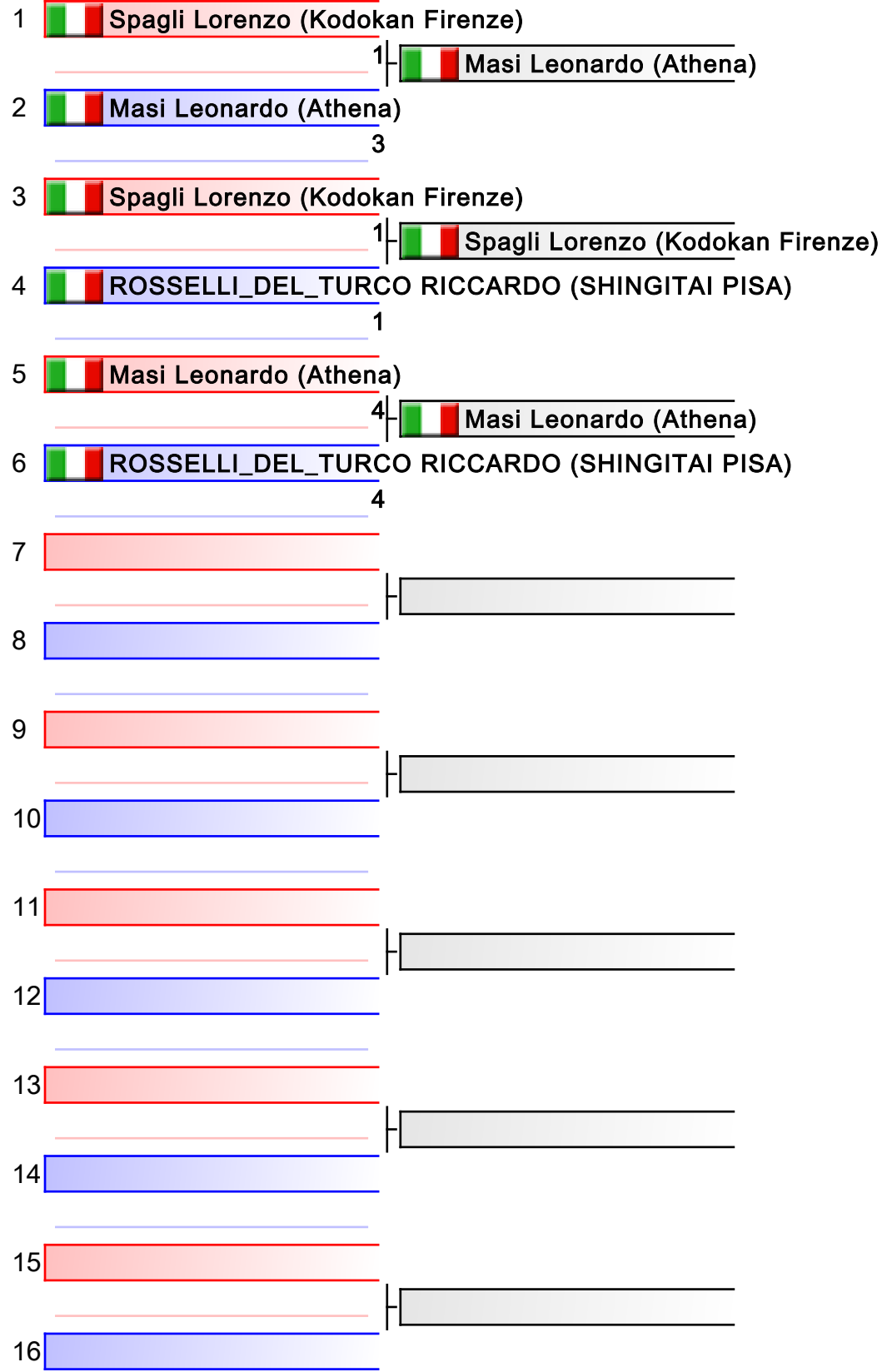

1. Masi Leonardo (Athena)
2. Spagli Lorenzo (Kodokan Firenze)
3. ROSSELLI_DEL_TURCO RICCARDO (SHINGITAI PISA)

Referees:			

Kumite M SEN -84 Kg - Round Robin (each against each)

Trofeo Toscana Primavera

Tatami
3

Pool
1/1

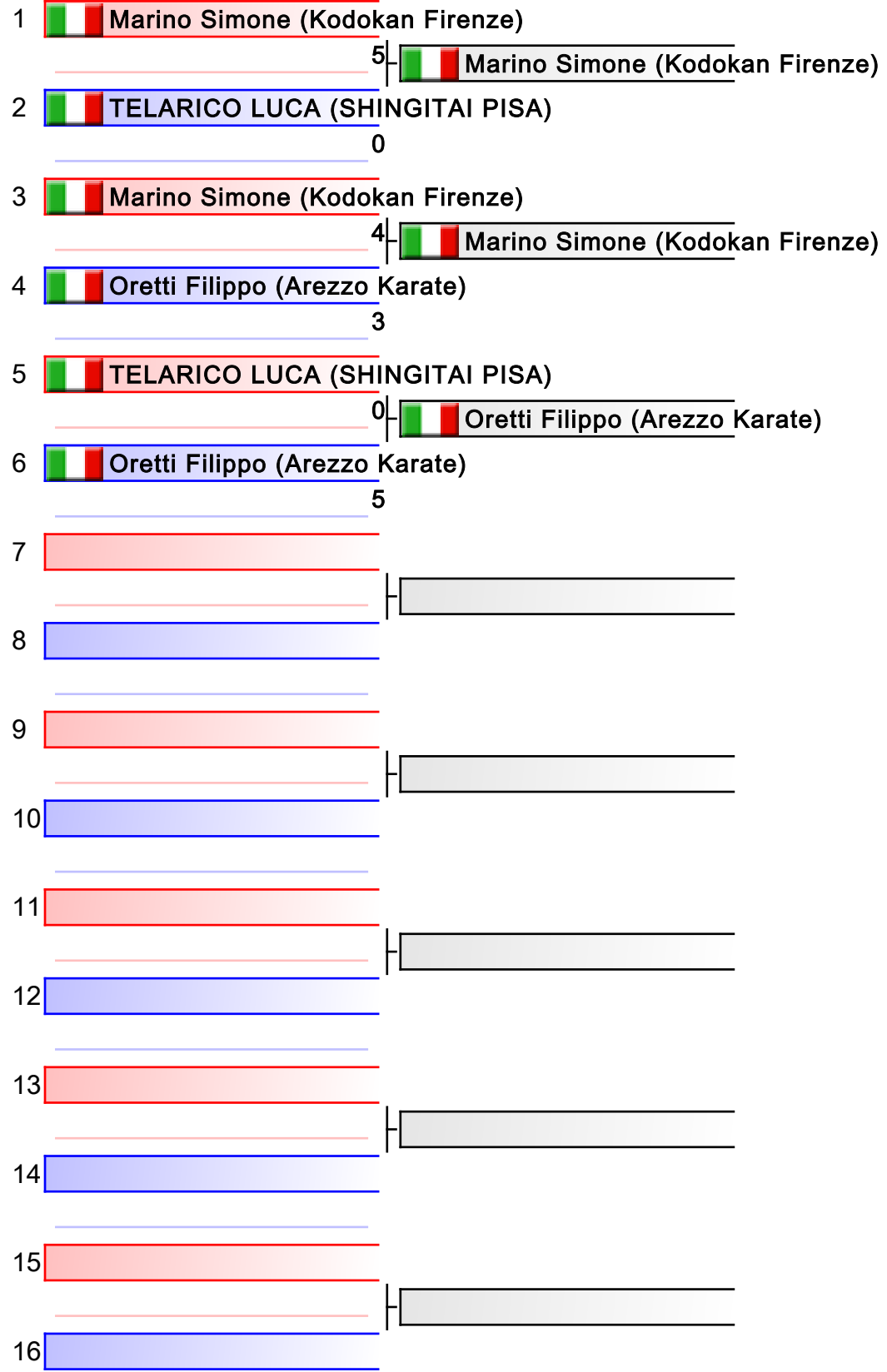

1. Marino Simone (Kodokan Firenze)
2. Oretti Filippo (Arezzo Karate)
3. TELARICO LUCA (SHINGITAI PISA)

Referees:			

Kumite M SEN -94 Kg - Round Robin (each against each)

Trofeo Toscana Primavera

Tatami

Pool
1/1

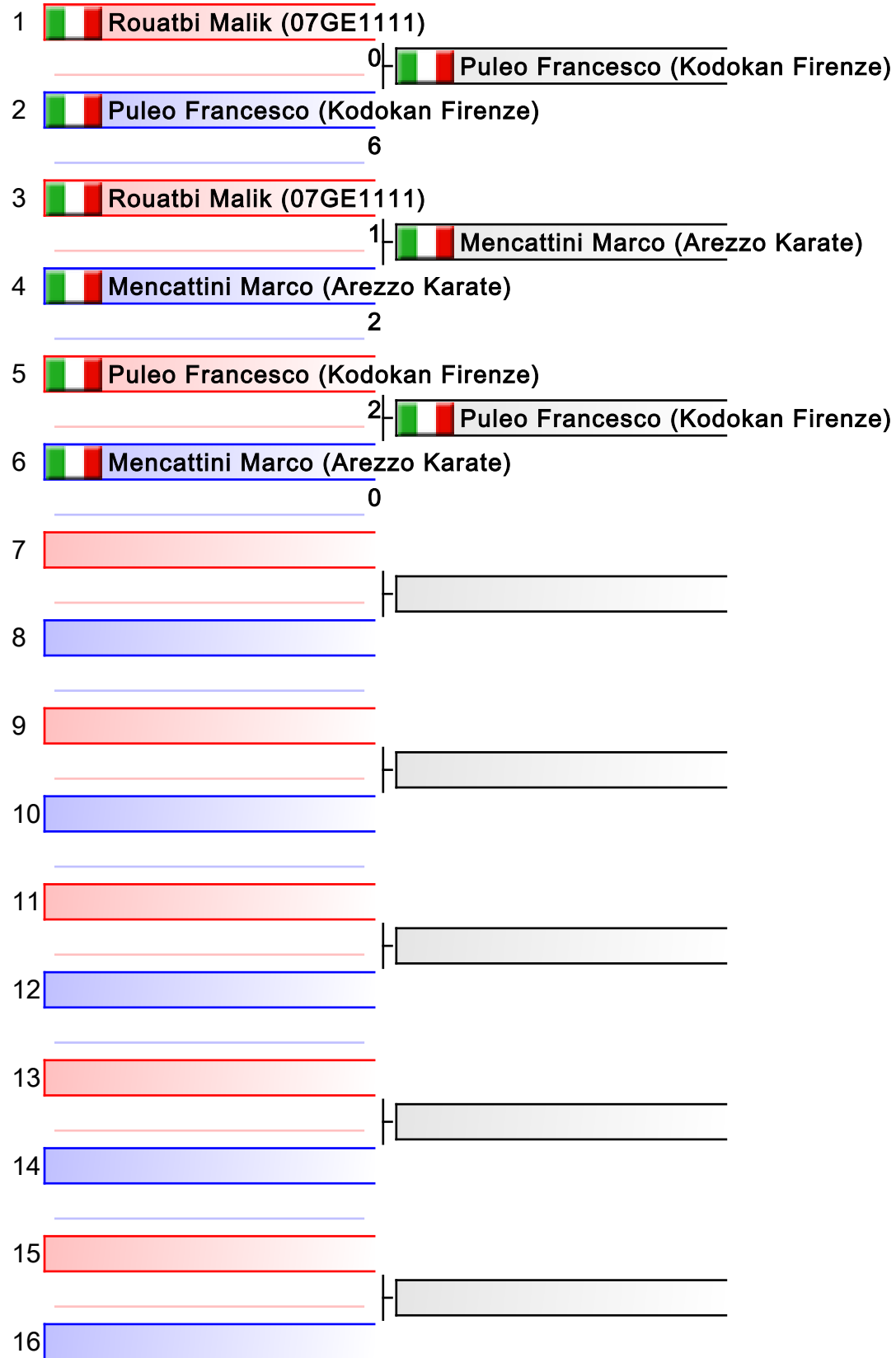

1. Puleo Francesco (Kodokan Firenze)
2. Mencattini Marco (Arezzo Karate)
3. Rouatbi Malik (07GE1111)

Referees:			

Kumite M SEN 55-60 Kg
Trofeo Toscana Primavera

Tatami **4**
Pool **1/1**

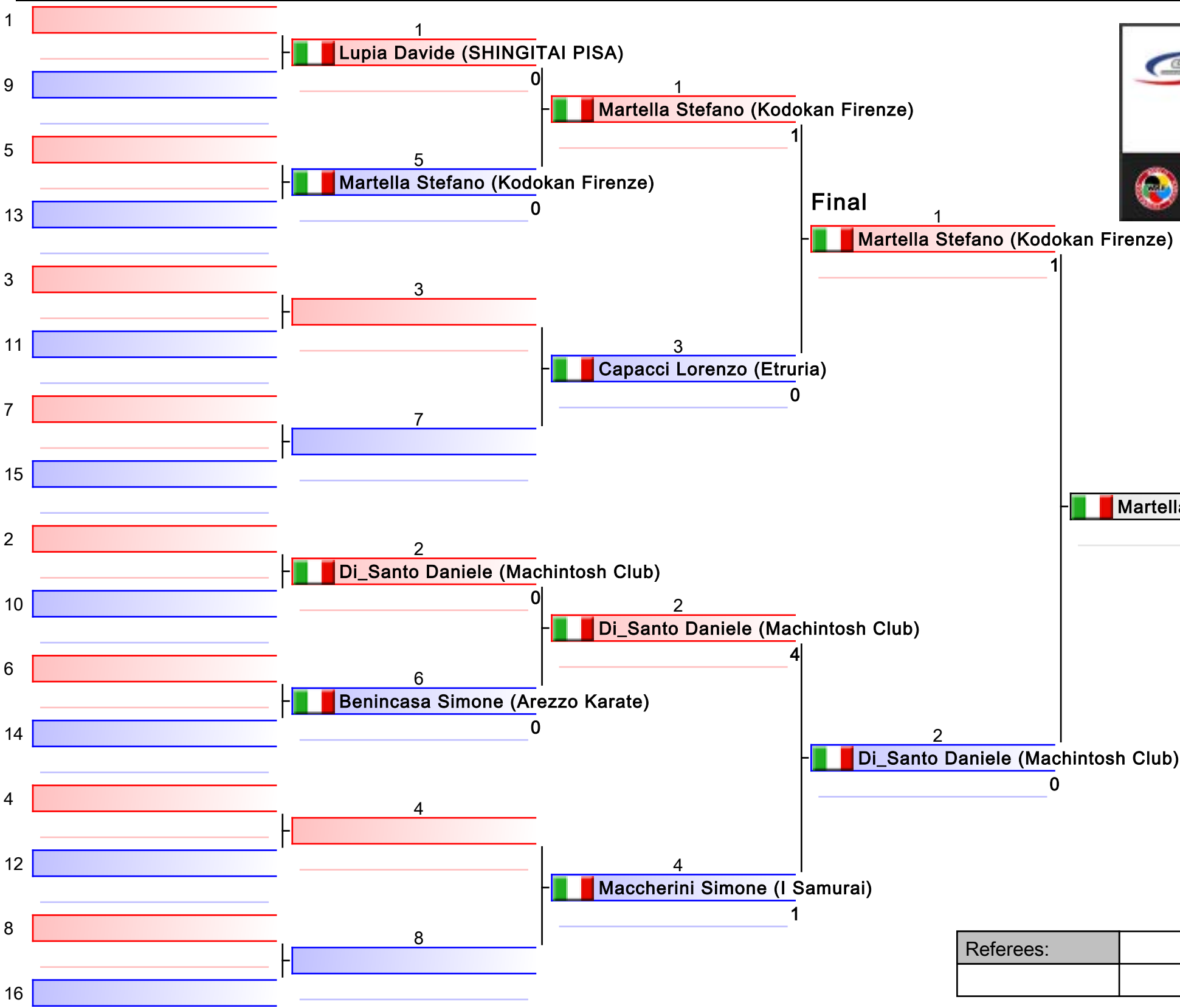

1. Martella Stefano (Kodokan Firenze)
2. Di_Santo Daniele (Machintosh Club)
3. Capacci Lorenzo (Etruria)
3. Benincasa Simone (Arezzo Karate)
5. Lupia Davide (SHINGITAI PISA)
5. Maccherini Simone (I Samurai)

Referees:			

Squadre Kata EsB-Cad F
Trofeo Toscana Primavera

Tatami
4

Pool
1/1

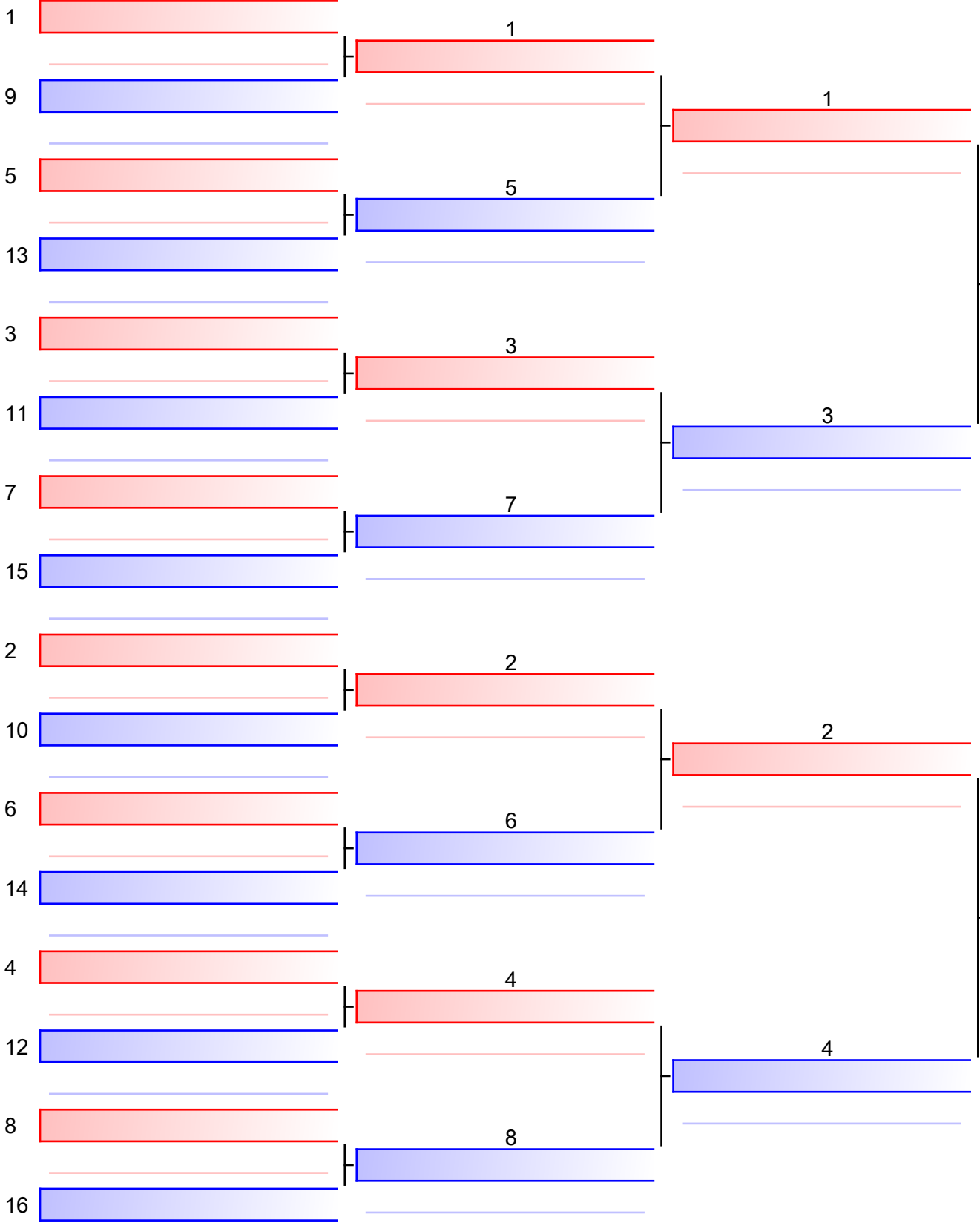

Final

AKS (Paoletti, Pontremolesi) (AKS)
Annan 5

AKS (Paoletti, Pontremolesi) (AKS)

PANARO (Caselli) (PANARO MODENA)
Gankaku 0

1. AKS (AKS)
2. PANARO (PANARO MODENA)

Referees:			

Squadre Kata Jun-Sen M
Trofeo Toscana Primavera

Tatami
4

Pool
1/1

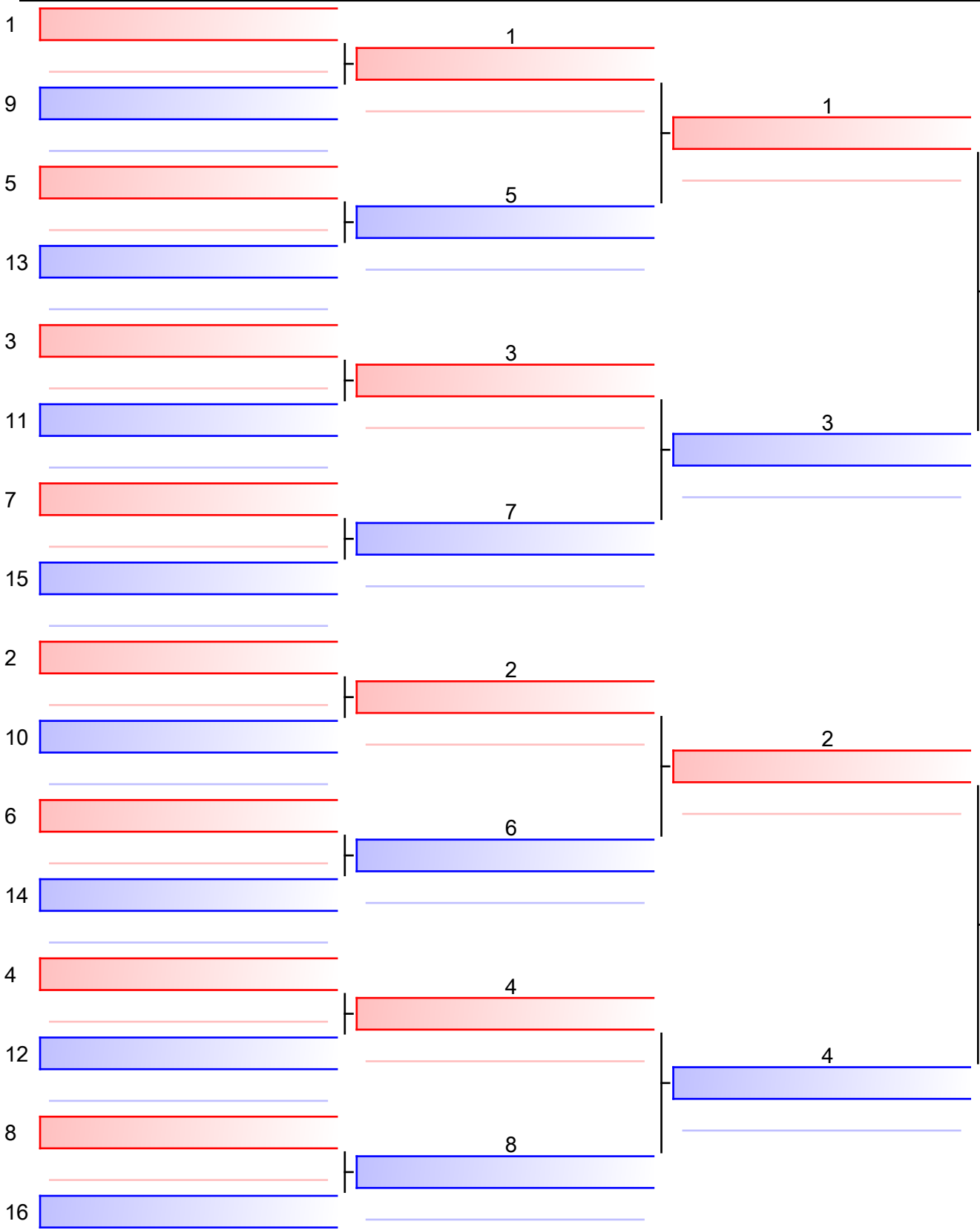

Final

1
Athena (Formoso, Scribani) (Athena)

Empi 5

1
2

Athena (Formoso, Scribani) (Athena)

2
PANARO (VACCARI, VINCIGUERRA, ZIGLIOLI) (PANARO MODENA)

Sochin 0

1. Athena (Athena)
2. PANARO (PANARO MODENA)

Referees:			

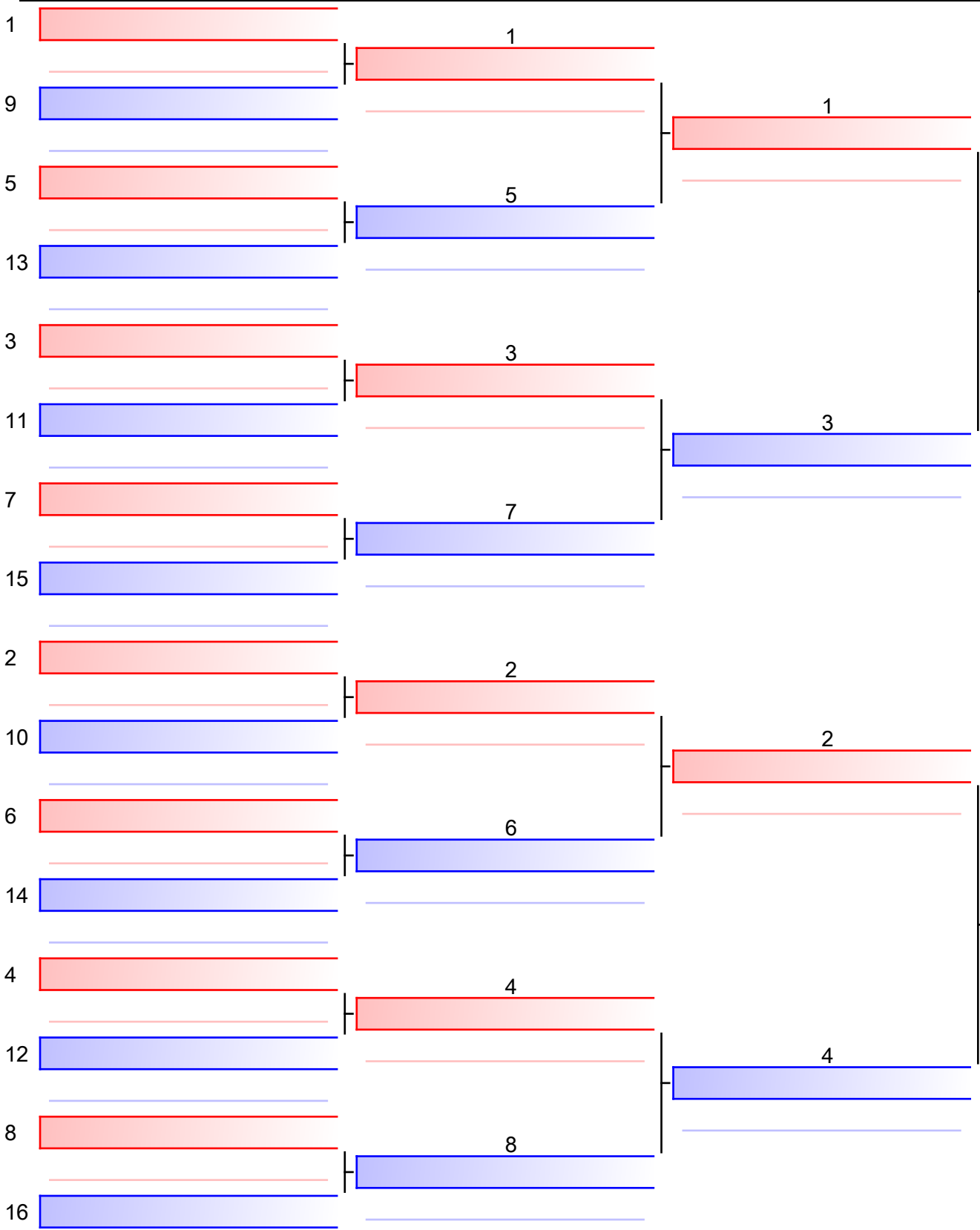

Final

1
AKS (Margheri, Pinzauti, Tapinassi) (AKS)

2

2
KODOKAN (Berti, Brenzini, Lucchesini, Reyes) (Kodokan Firenze)

2
KODOKAN (Berti, Brenzini, Lucchesini, Reyes) (Kodokan Firenze)

3

1. KODOKAN (Kodokan Firenze)
2. AKS (AKS)

Referees:			

Squadre Kumite M Jun-Sen - Round Robin (each against each)

Trofeo Toscana Primavera

Tatami
3

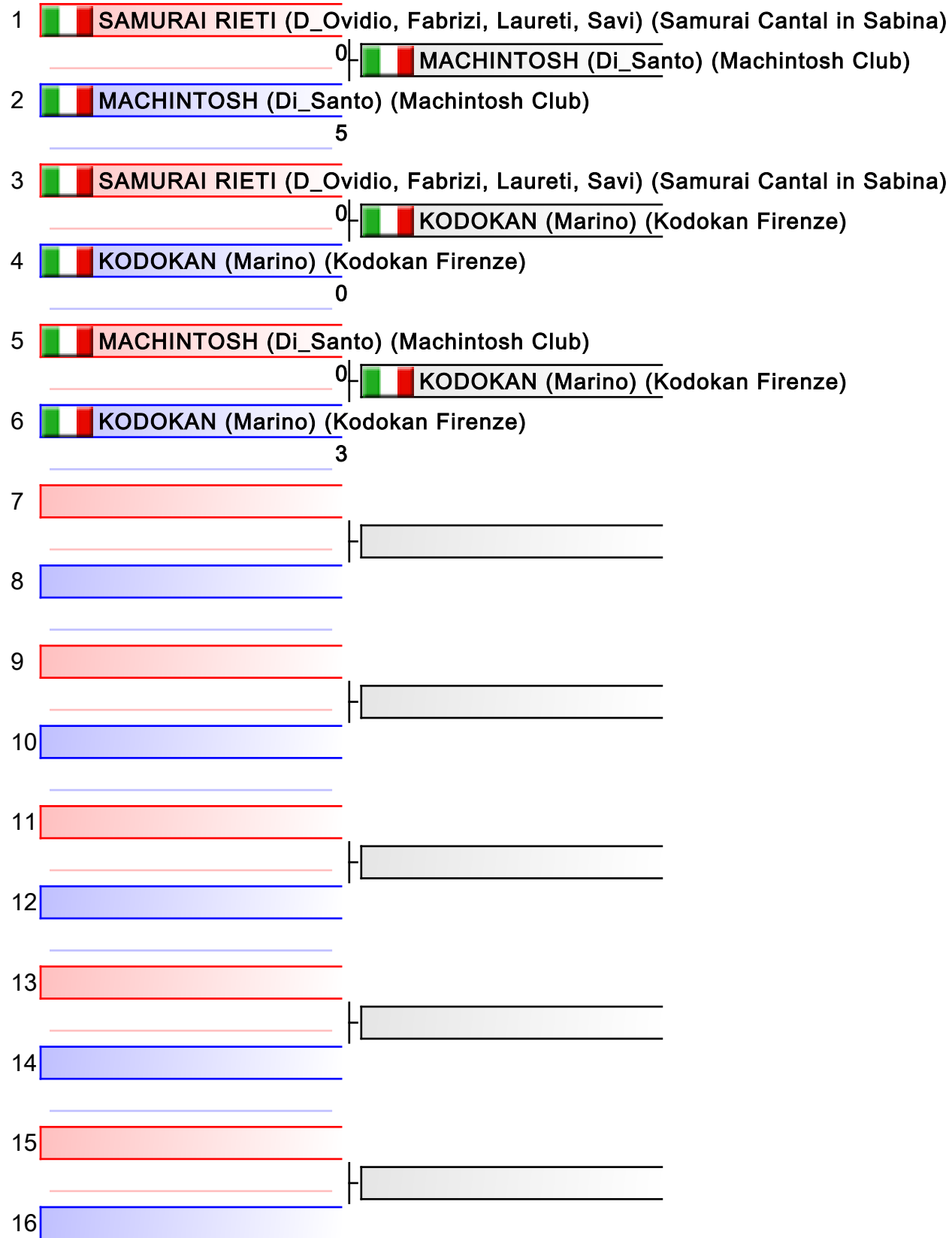

Pool
1/1

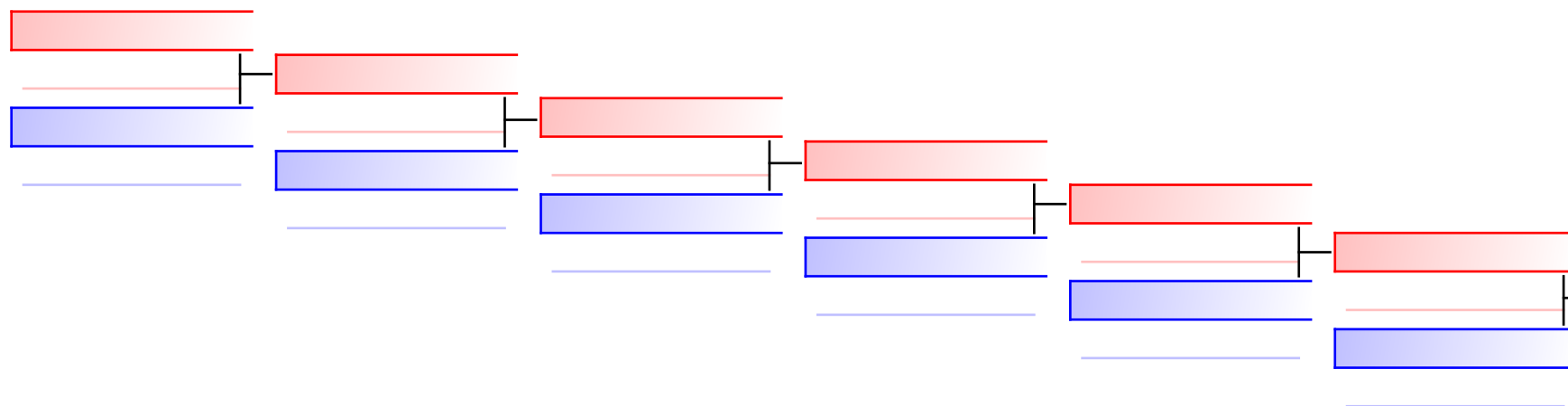

1. KODOKAN (Kodokan Firenze)
2. MACHINTOSH (Machintosh Club)
3. SAMURAI RIETI (Samurai Cantal in Sabina)

Referees:			



 **Colasurdo Simona (AKS)**
Nipaipo 0
 **Sciamanda Chiara (SHINGITAI PISA)**
Annan 5

REPECHAGE: B - Kata F Cad(1)

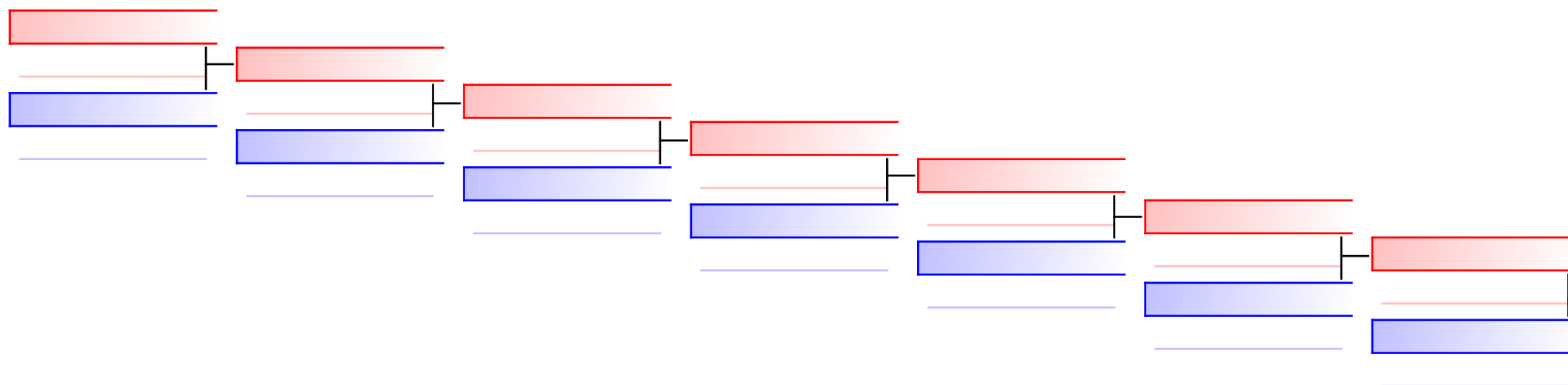

 **Caselli Laura (PANARO MODE)**

Referees:							
-----------	--	--	--	--	--	--	--

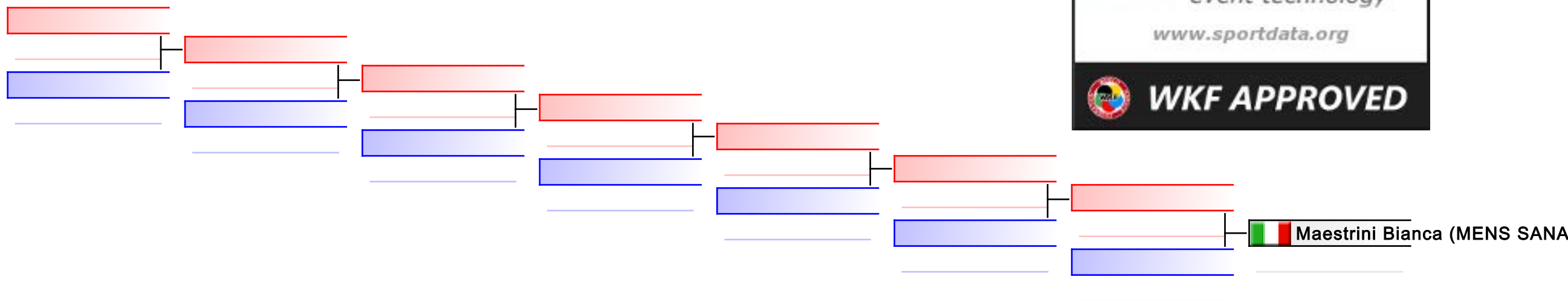

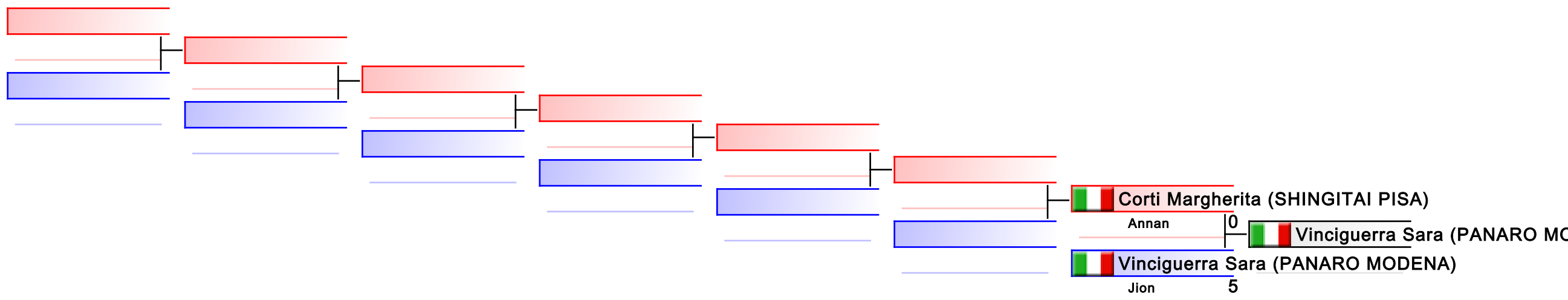

REPECHAGE: B - Kata F Es.A(1)

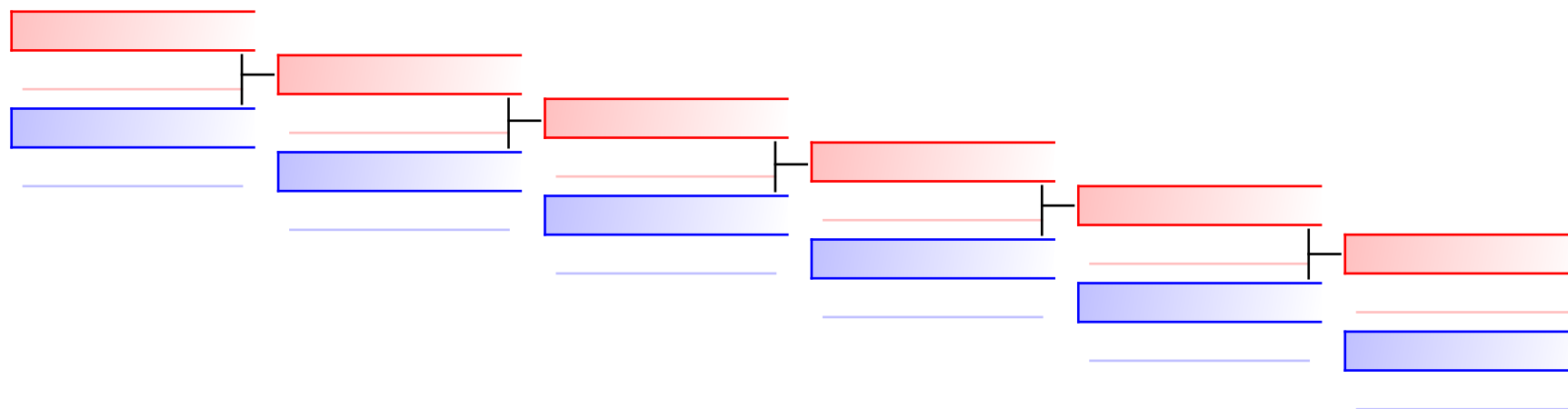

Referees:							
-----------	--	--	--	--	--	--	--



 **Boanini Margherita (Tre Pietre)**
 Pinan Godan | 2
  **Bianchi Ilaria (Karate Kwai Pesca)**
 **Bianchi Ilaria (Karate Kwai Pesca)**
 Heian Sandan | 3

REPECHAGE: B - Kata F Es.B(1)

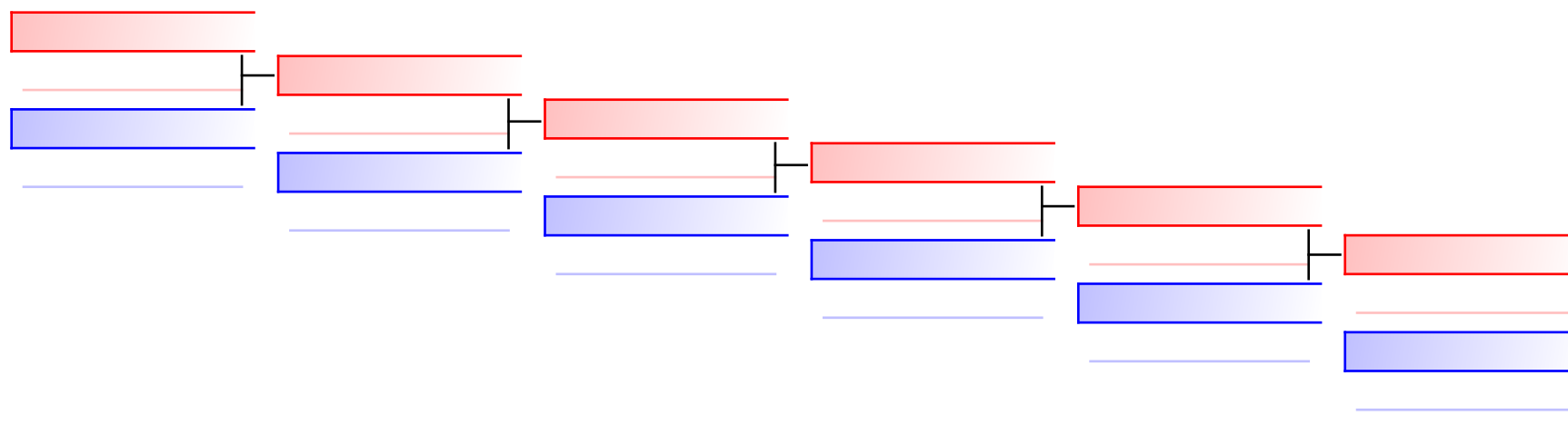

 **Colasurdo Simona (AKS)**
 Unshu | 0
  **Fanti Agnese (Centro A.M. Lucca)**
 **Fanti Agnese (Centro A.M. Lucca)**
 Empi | 5

Referees:							
-----------	--	--	--	--	--	--	--

B - Kata F Juniores

Trofeo Toscana Primavera

(c)sportdata GmbH & Co KG 2000-2015(2015-04-27 10:12) -WKF Approved- v 8.4.0 build 1 License: FIJLKAM 2015 (expire 2015-12-31)

Tatami
1

Pool
1

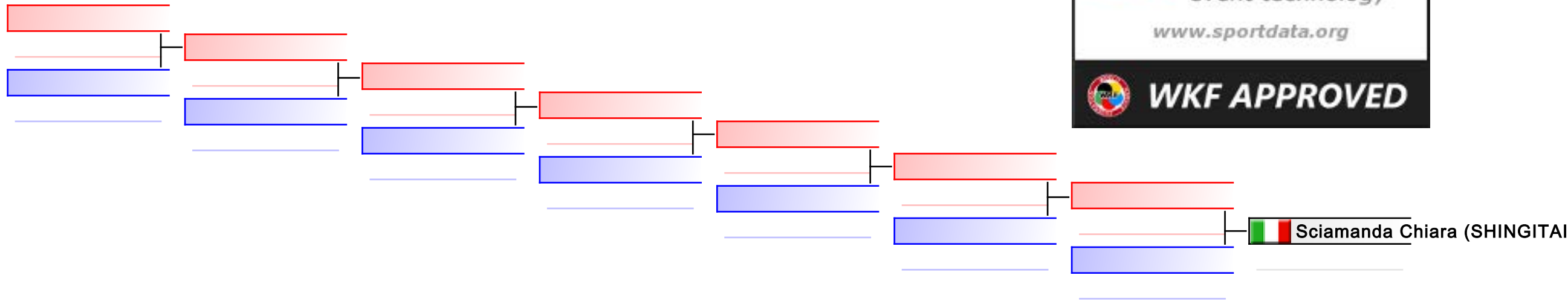

REPECHAGE: B - Kata F Juniores(1)

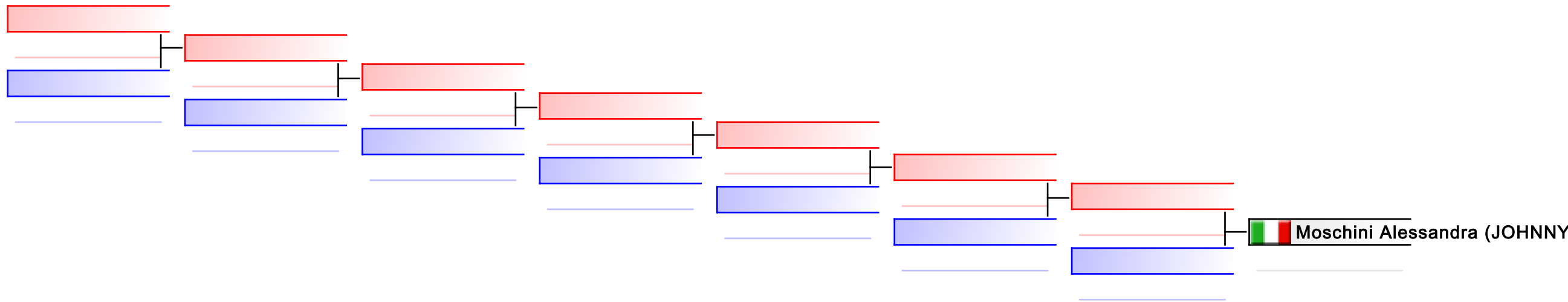

Referees:							
-----------	--	--	--	--	--	--	--

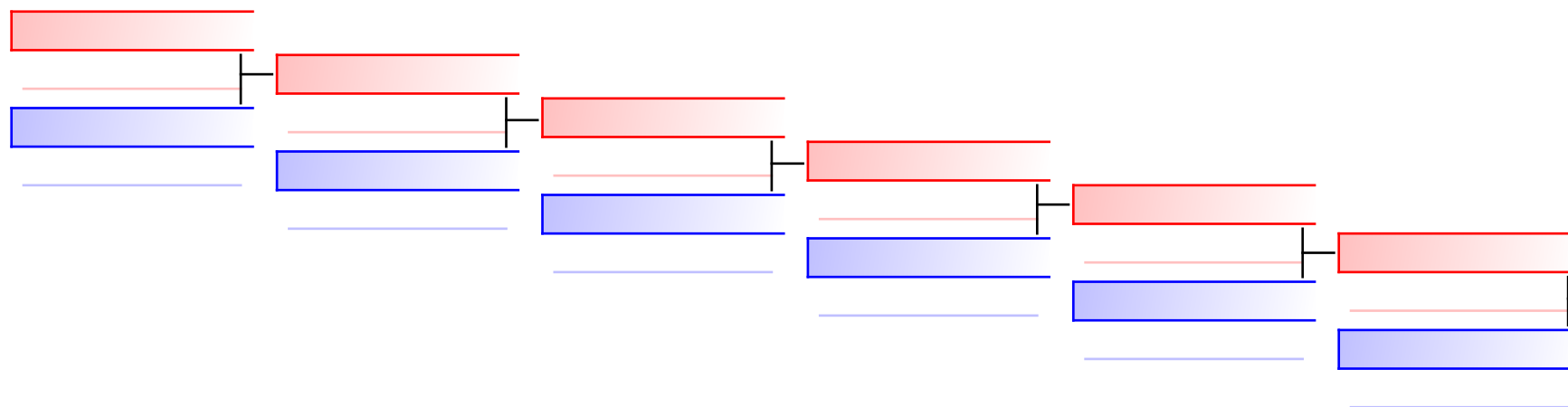

ZIGLIOLI DAVIDE (PANARO MODENA)
Sochin 5
 ZIGLIOLI DAVIDE (PANARO M)
 Moretti Nicholas (Athena)
Jion 0

REPECHAGE: B - Kata M Cad(1)

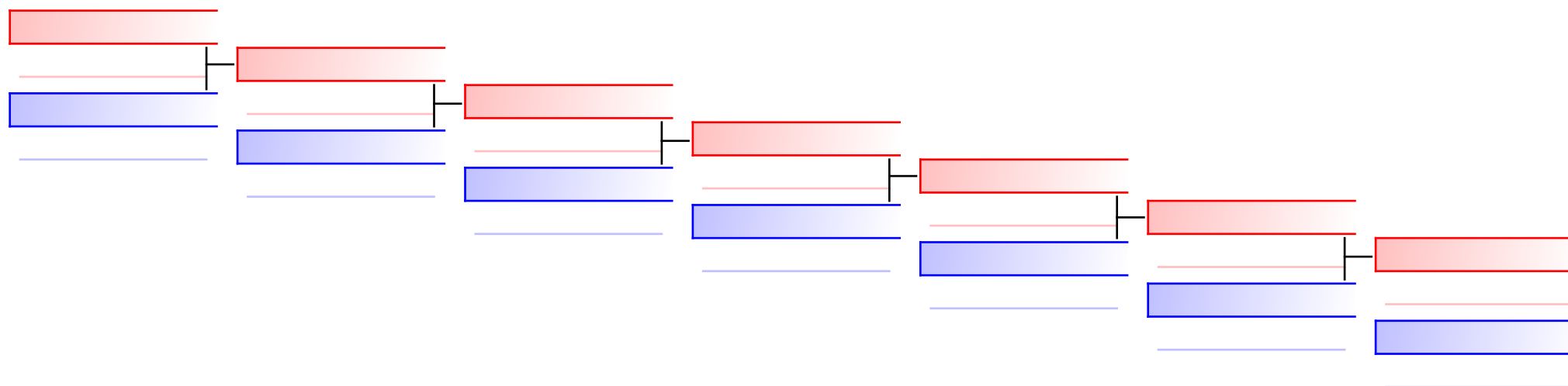

Bazialli Dario (Ronin Karate Liv)

Referees:							
-----------	--	--	--	--	--	--	--

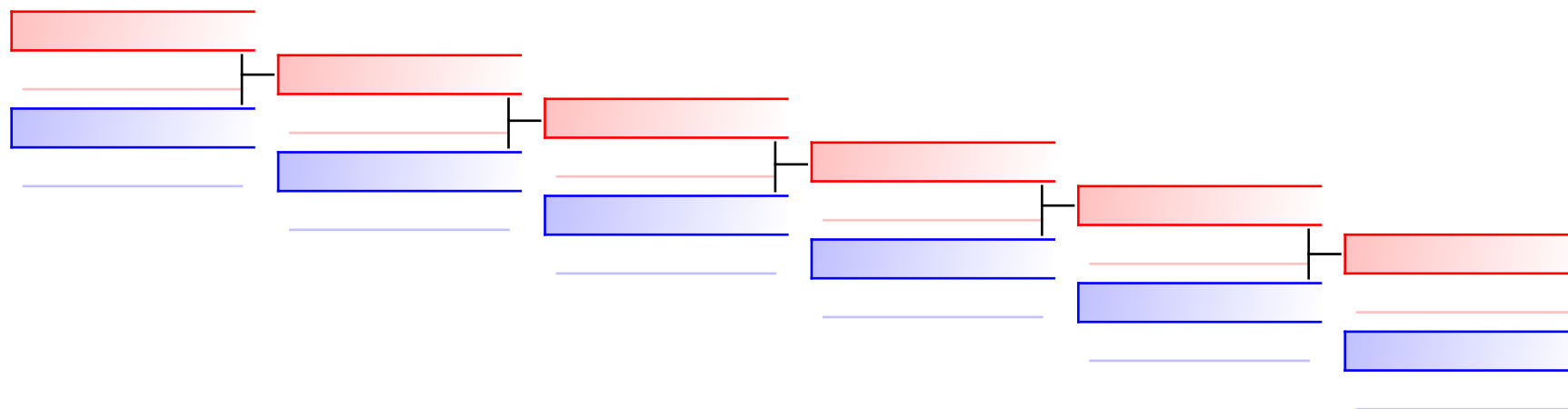

GUARNIERI GREGORIO (PUNTO SPORT)
Kanku Dai 0

Morelli Giacomo (Ronin Karate Livorno)
Kanku Dai 5

REPECHAGE: B - Kata M Es.B(1)

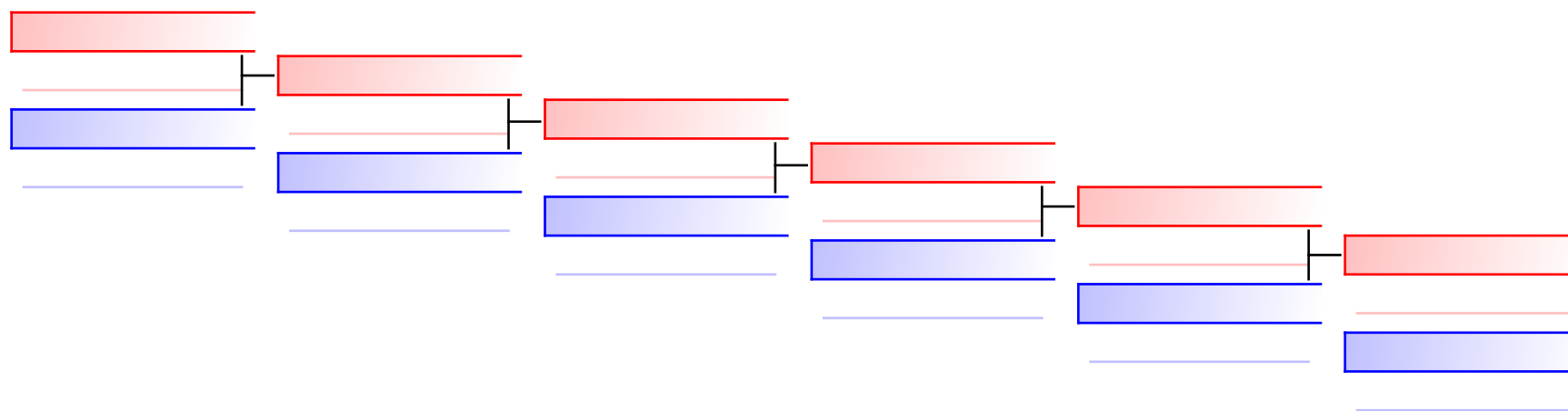

Bazialli Dario (Ronin Karate Livorno)
Empi 5

Bazialli Dario (Ronin Karate Livorno)
Empi 5

Bernabei Mattia (PUNTO SPORT)
Kanku Sho 0

Referees:							
-----------	--	--	--	--	--	--	--

B - Kumite F Es.A 32-37 Kg

Trofeo Toscana Primavera

(c)sportdata GmbH & Co KG 2000-2015(2015-04-27 10:12) -WKF Approved- v 8.4.0 build 1 License: FIJLKAM 2015 (expire 2015-12-31)

Tatami
3

Pool
1

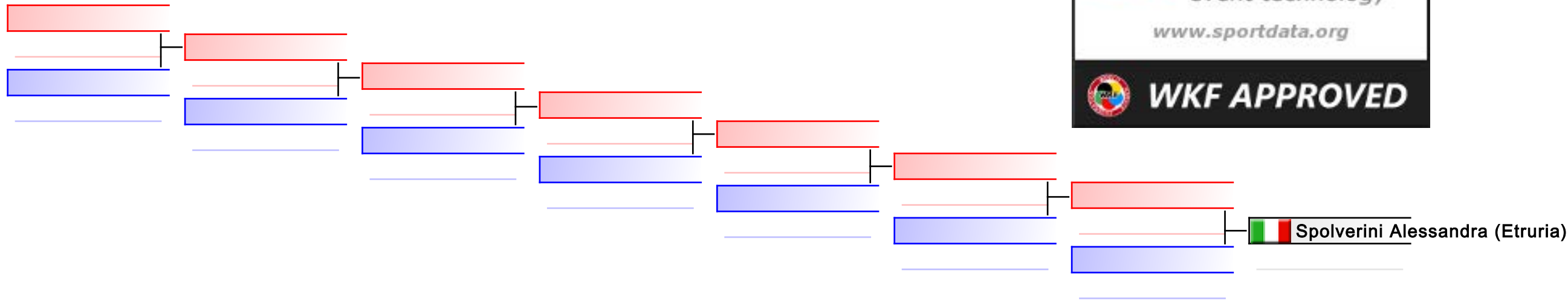

REPECHAGE: B - Kumite F Es.A 32-37 Kg(1)

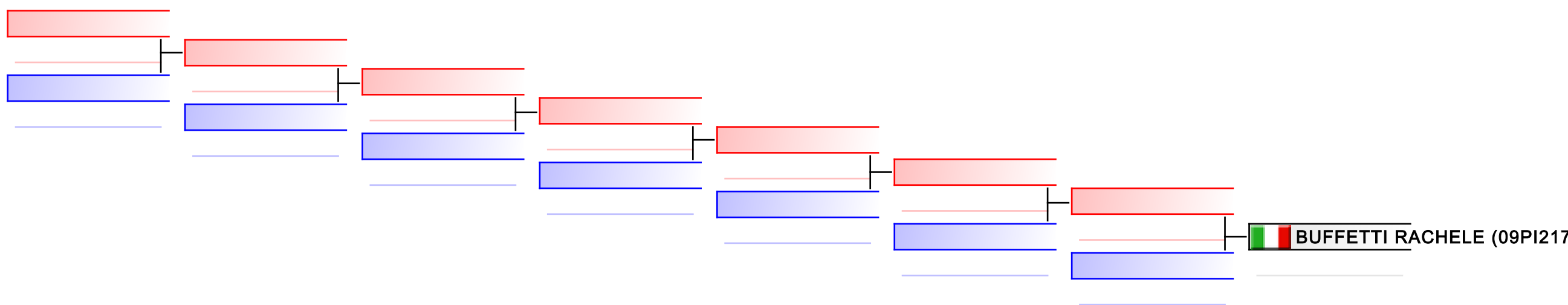

Referees:							
-----------	--	--	--	--	--	--	--

B - Kumite F Es.A 47 Kg



Trofeo Toscana Primavera

(c)sportdata GmbH & Co KG 2000-2015(2015-04-27 10:12) -WKF Approved- v 8.4.0 build 1 License: FIJLKAM 2015 (expire 2015-12-31)

Tatami
4

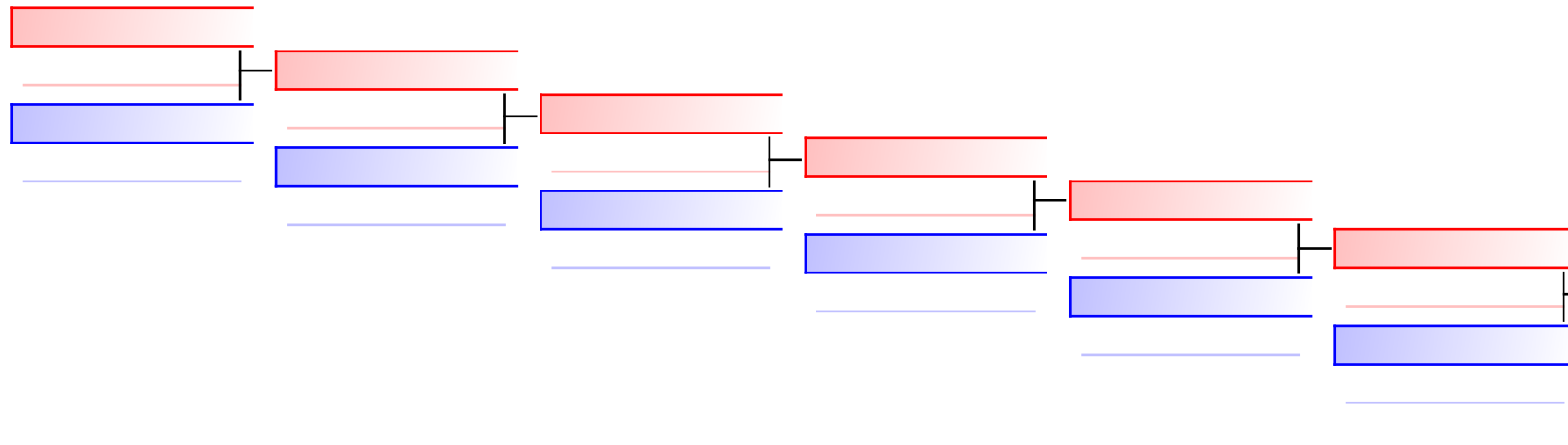
Pool
1



 Cuccia Alessia (AKS)
0
 Cuccia Alessia (AKS)
 Puccinelli Maria (Bodymind Karate)
0

REPECHAGE: B - Kumite F Es.A 47 Kg(1)

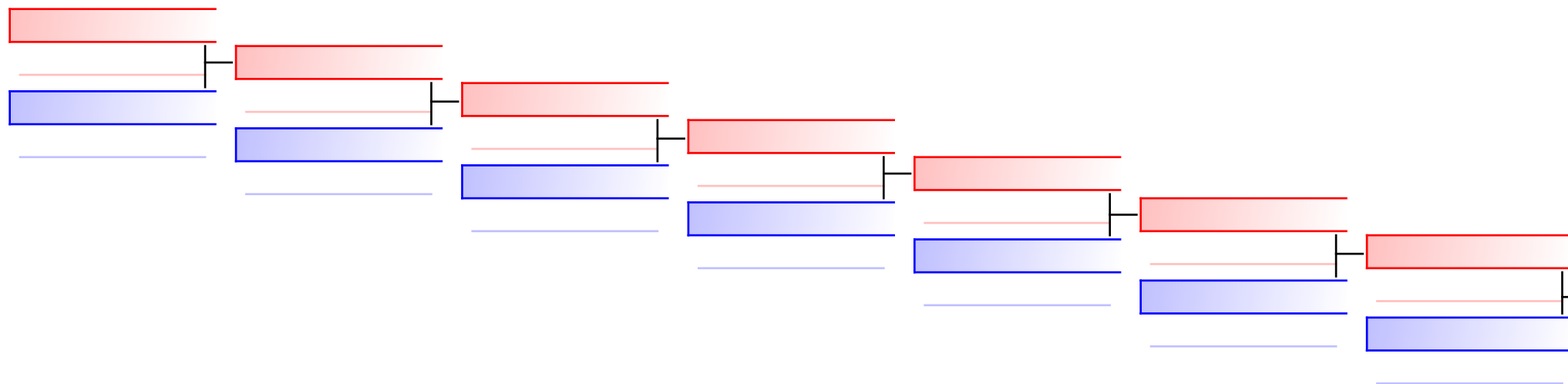

 Guidetti Alessia (Don Bosco)

Referees:							
-----------	--	--	--	--	--	--	--

B - Kumite F Es.A 53 Kg

Trofeo Toscana Primavera

(c)sportdata GmbH & Co KG 2000-2015(2015-04-27 10:12) -WKF Approved- v 8.4.0 build 1 License: FIJLKAM 2015 (expire 2015-12-31)

Tatami
3

Pool
1

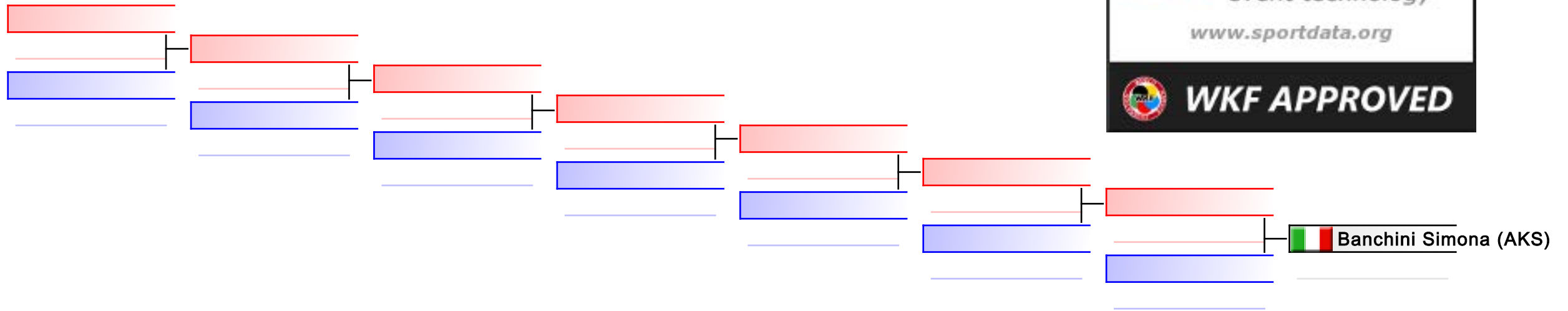

REPECHAGE: B - Kumite F Es.A 53 Kg(1)

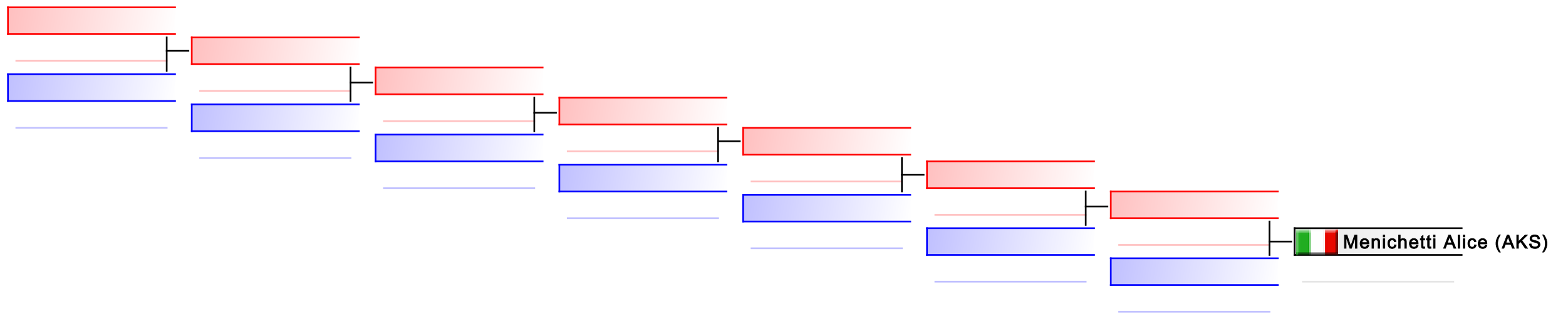

Referees:							
-----------	--	--	--	--	--	--	--

B - Kumite F Es.B 63 Kg



Trofeo Toscana Primavera

(c)sportdata GmbH & Co KG 2000-2015(2015-04-27 10:12) -WKF Approved- v 8.4.0 build 1 License: FIJLKAM 2015 (expire 2015-12-31)

Tatami
3

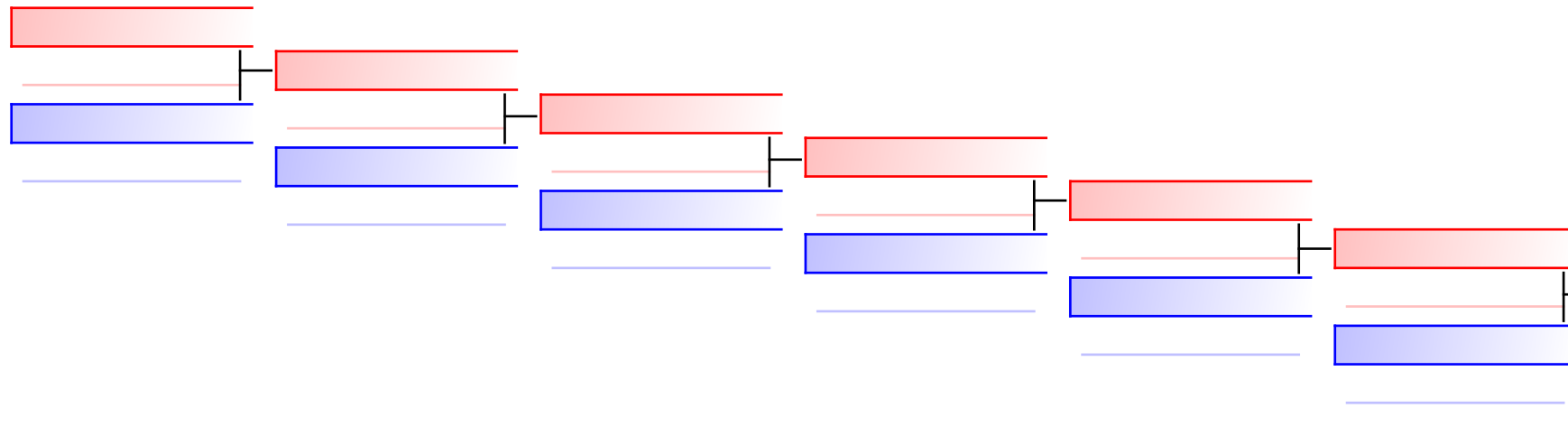
Pool
1



 Cetoloni Sara (MENS SANA)
 Cetoloni Sara (MENS SANA)
 Dini Berisha (SportTarget Castelfranco)

REPECHAGE: B - Kumite F Es.B 63 Kg(1)

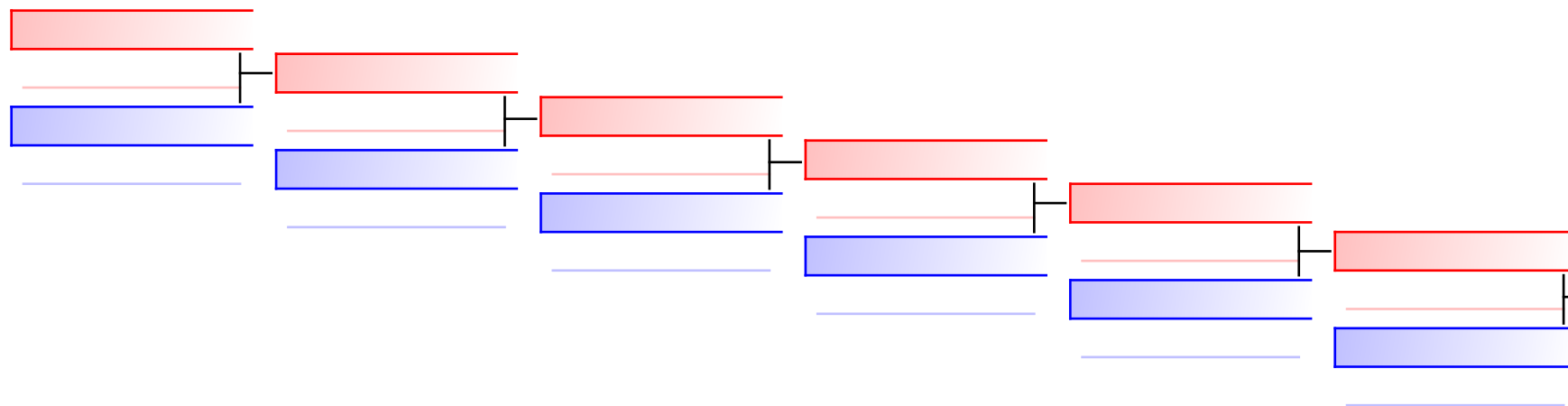

 Lenzi Eva (Sakura Piombino)
 Lenzi Eva (Sakura Piombino)
 Meneghini Camilla (Accademia Lotte Orientali)

Referees:							
-----------	--	--	--	--	--	--	--

B - Kumite F Jun 55 kg

Trofeo Toscana Primavera

(c)sportdata GmbH & Co KG 2000-2015(2015-04-27 10:12) -WKF Approved- v 8.4.0 build 1 License: FIJLKAM 2015 (expire 2015-12-31)

Tatami

Pool
1

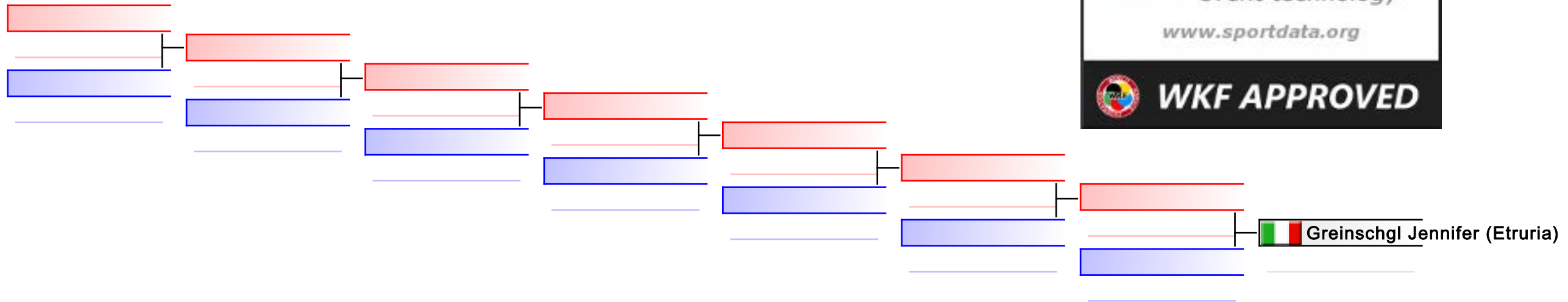

REPECHAGE: B - Kumite F Jun 55 kg(1)

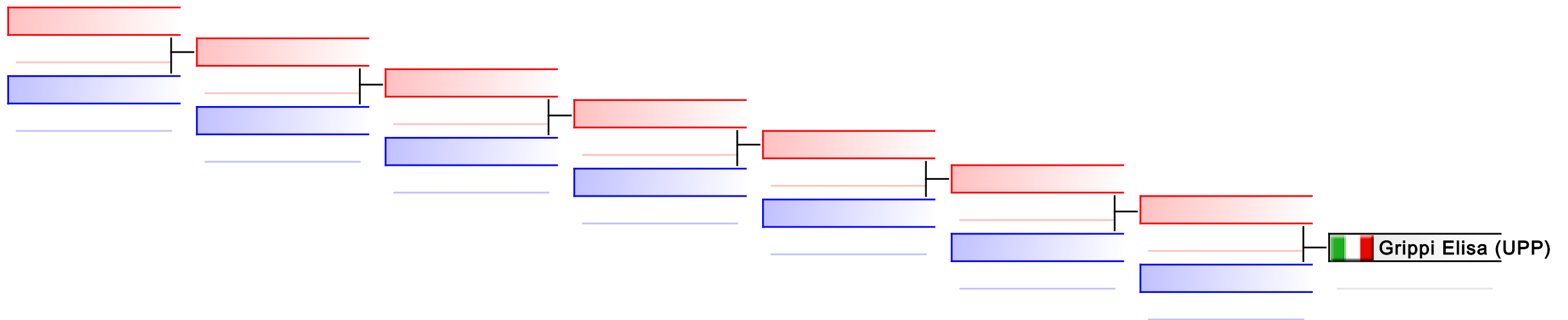

Referees:							
-----------	--	--	--	--	--	--	--

B - Kumite M Cad 68 Kg

Trofeo Toscana Primavera

(c)sportdata GmbH & Co KG 2000-2015(2015-04-27 10:12) -WKF Approved- v 8.4.0 build 1 License: FIJLKAM 2015 (expire 2015-12-31)

Tatami
4

Pool
1

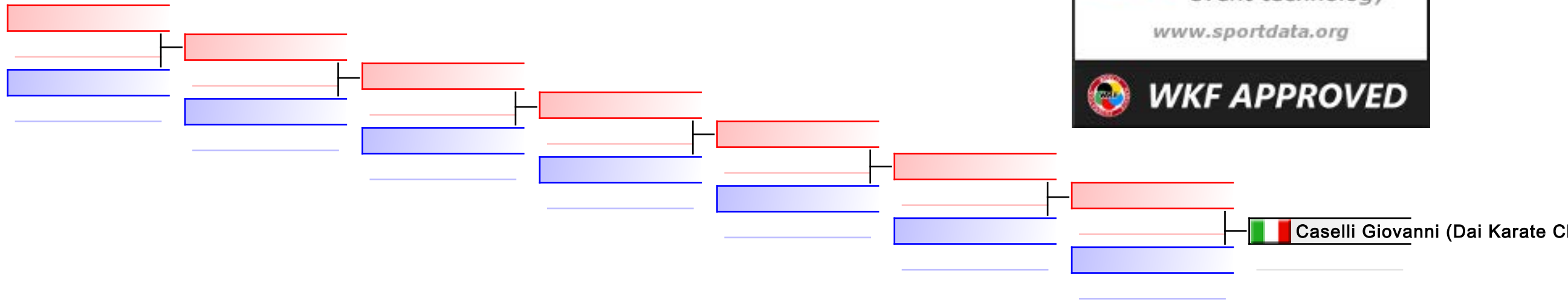

REPECHAGE: B - Kumite M Cad 68 Kg(1)

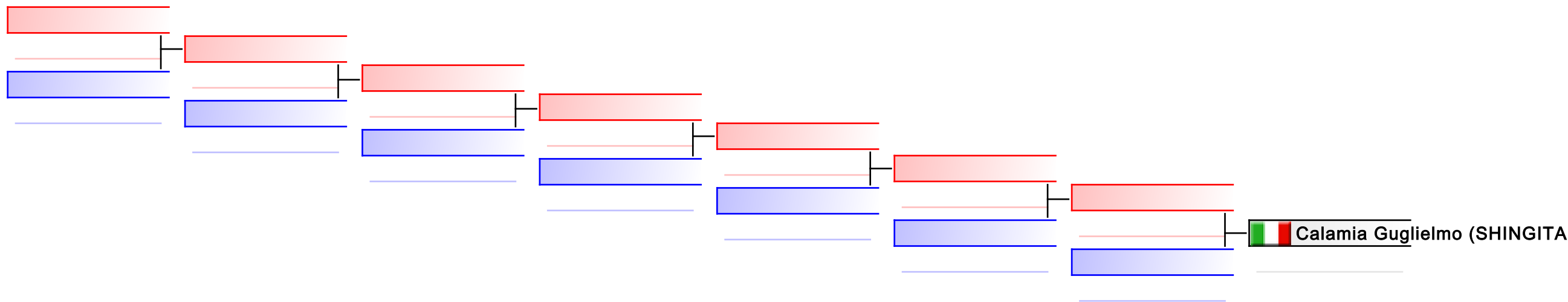

Referees:							
-----------	--	--	--	--	--	--	--

B - Kumite M Es.A 35-40 Kg



Trofeo Toscana Primavera

(c)sportdata GmbH & Co KG 2000-2015(2015-04-27 10:12) -WKF Approved- v 8.4.0 build 1 License: FIJKAM 2015 (expire 2015-12-31)

Tatami
1

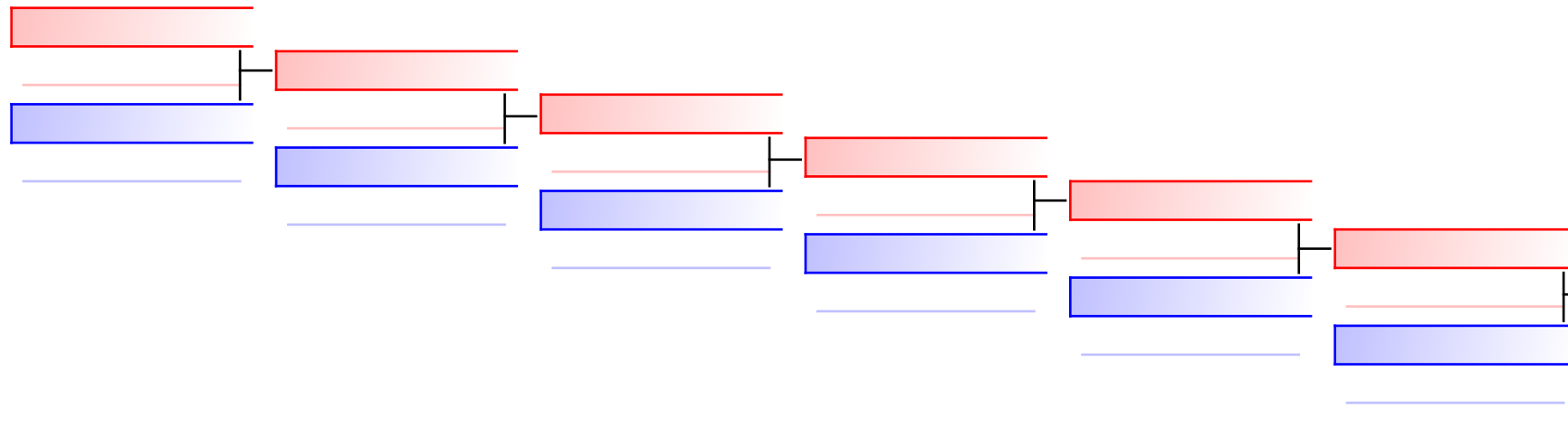
Pool
1



 Fonte Francesco (Bodymind Karate) 0
 Cioncolini Thomas (Accad Kara...)
 Cioncolini Thomas (Accad Karate Sh Valdarno) 3

REPECHAGE: B - Kumite M Es.A 35-40 Kg(1)

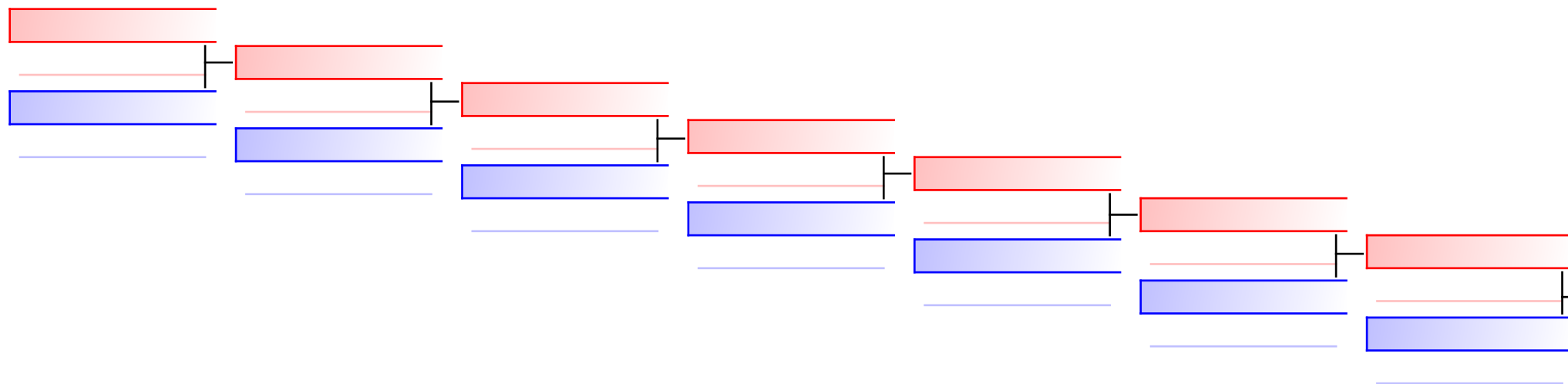

 Perotto Elia (Don Bosco)

Referees:							
-----------	--	--	--	--	--	--	--

B - Kumite M Es.A 45 kg

Trofeo Toscana Primavera

(c)sportdata GmbH & Co KG 2000-2015(2015-04-27 10:12) -WKF Approved- v 8.4.0 build 1 License: FIJLKAM 2015 (expire 2015-12-31)

Tatami
1

Pool
1

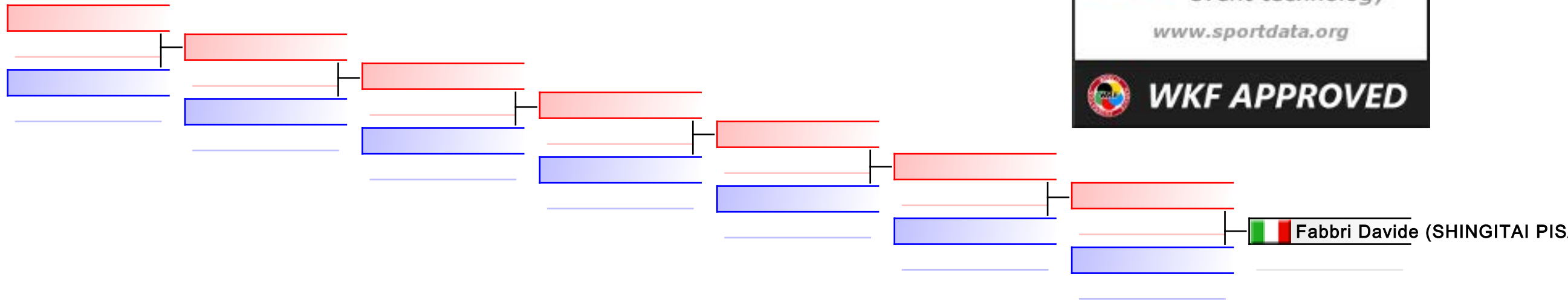

REPECHAGE: B - Kumite M Es.A 45 kg(1)

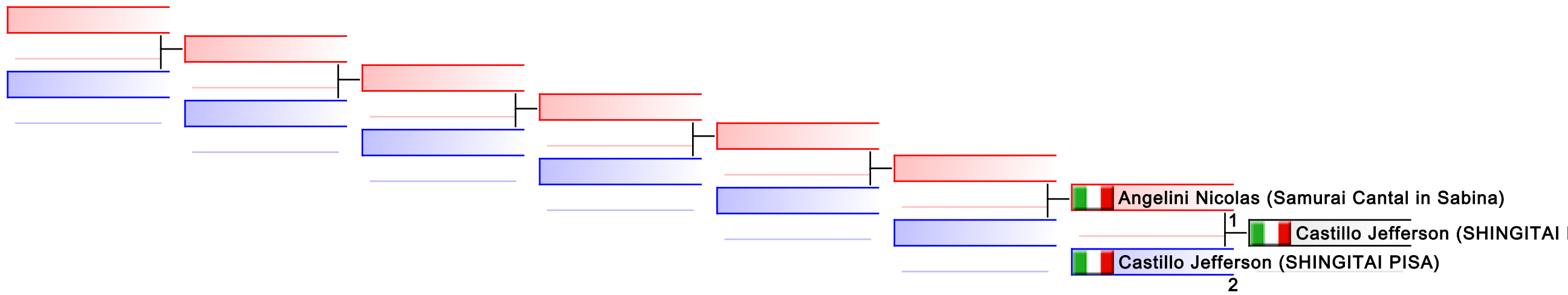

Referees:							
-----------	--	--	--	--	--	--	--

B - Kumite M Es.A 50 Kg

Trofeo Toscana Primavera

(c)sportdata GmbH & Co KG 2000-2015(2015-04-27 10:12) -WKF Approved- v 8.4.0 build 1 License: FIJLKAM 2015 (expire 2015-12-31)

Tatami	Pool
2	1

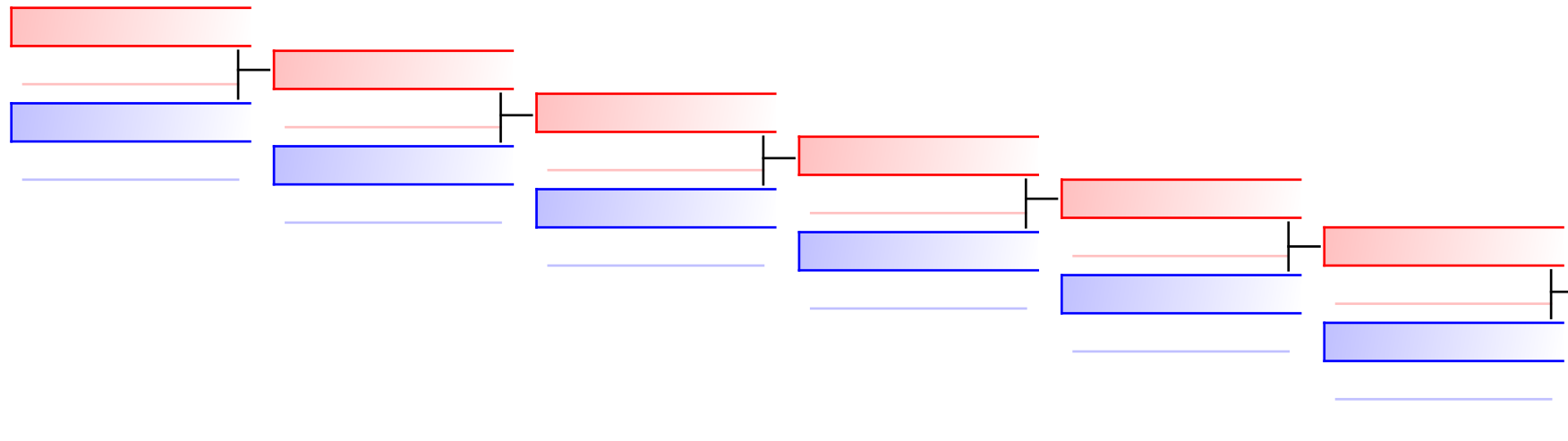

Dqjq Hatim (Don Bosco)
 3
Dqjq Hatim (Don Bosco)
Avuri Lorenzo (CKS Certaldo)
 0

REPECHAGE: B - Kumite M Es.A 50 Kg(1)

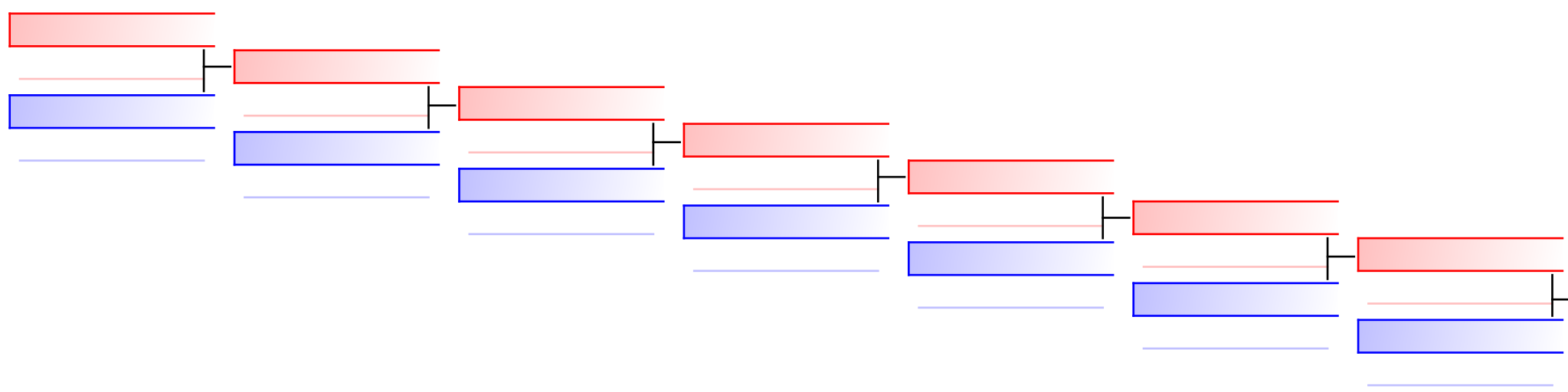

Tortelli Michael (AKC)

Referees:							
-----------	--	--	--	--	--	--	--

B - Kumite M Es.A 61 Kg

Trofeo Toscana Primavera

(c)sportdata GmbH & Co KG 2000-2015(2015-04-27 10:12) -WKF Approved- v 8.4.0 build 1 License: FIJLKAM 2015 (expire 2015-12-31)

Tatami	Pool
2	1

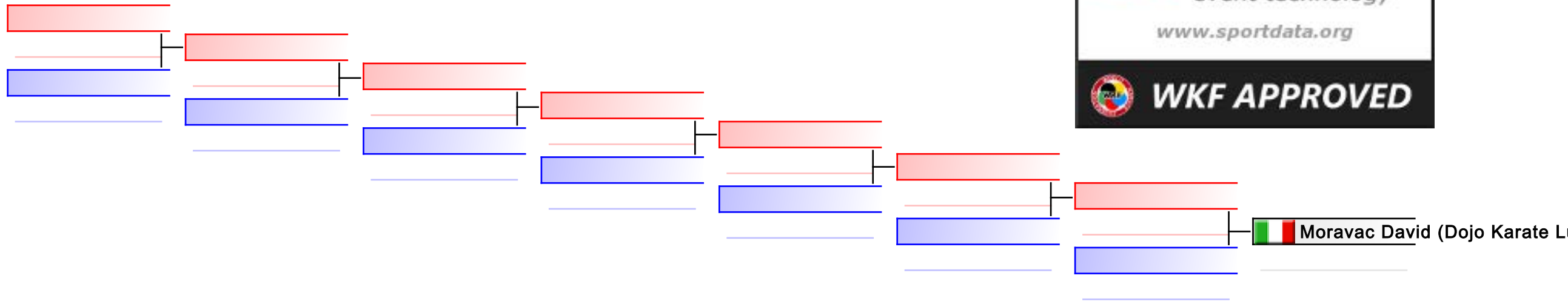

REPECHAGE: B - Kumite M Es.A 61 Kg(1)

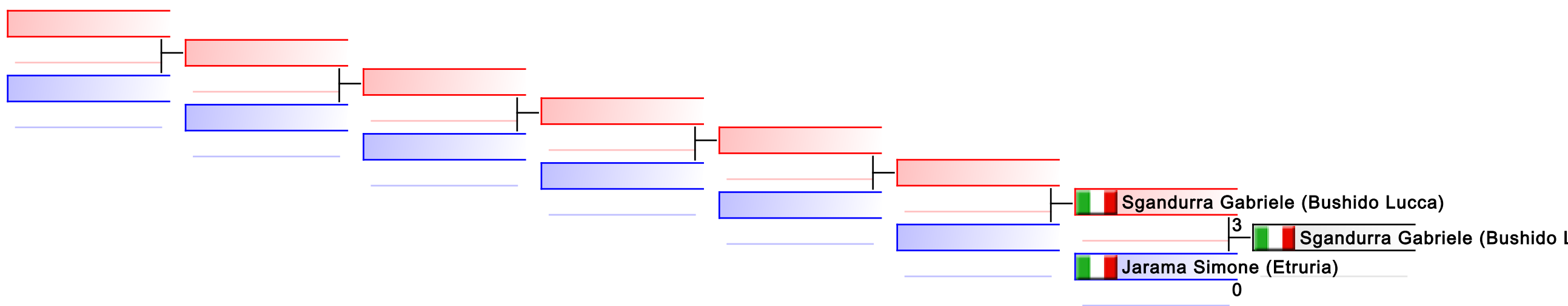

Referees:							
-----------	--	--	--	--	--	--	--

B - Kumite M Es.B 63 Kg

Trofeo Toscana Primavera

(c)sportdata GmbH & Co KG 2000-2015(2015-04-27 10:12) -WKF Approved- v 8.4.0 build 1 License: FIJLKAM 2015 (expire 2015-12-31)

Tatami	Pool
2	1

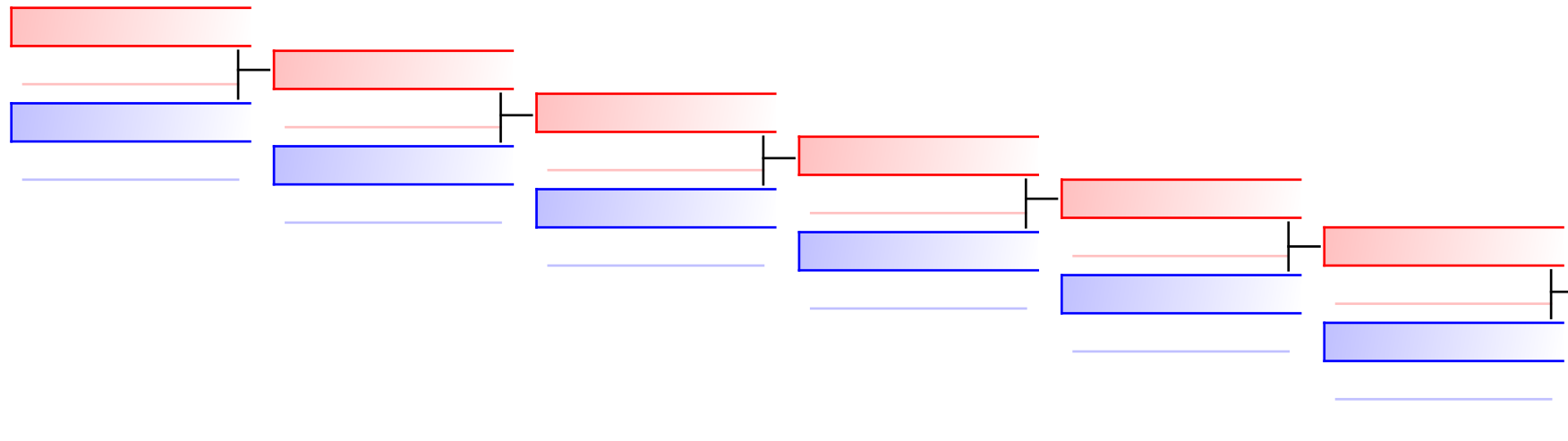

Angelini Thomas (Samurai Cantal in Sabina) 0
 Cesari Riccardo (Centro Sferologico) 1

REPECHAGE: B - Kumite M Es.B 63 Kg(1)

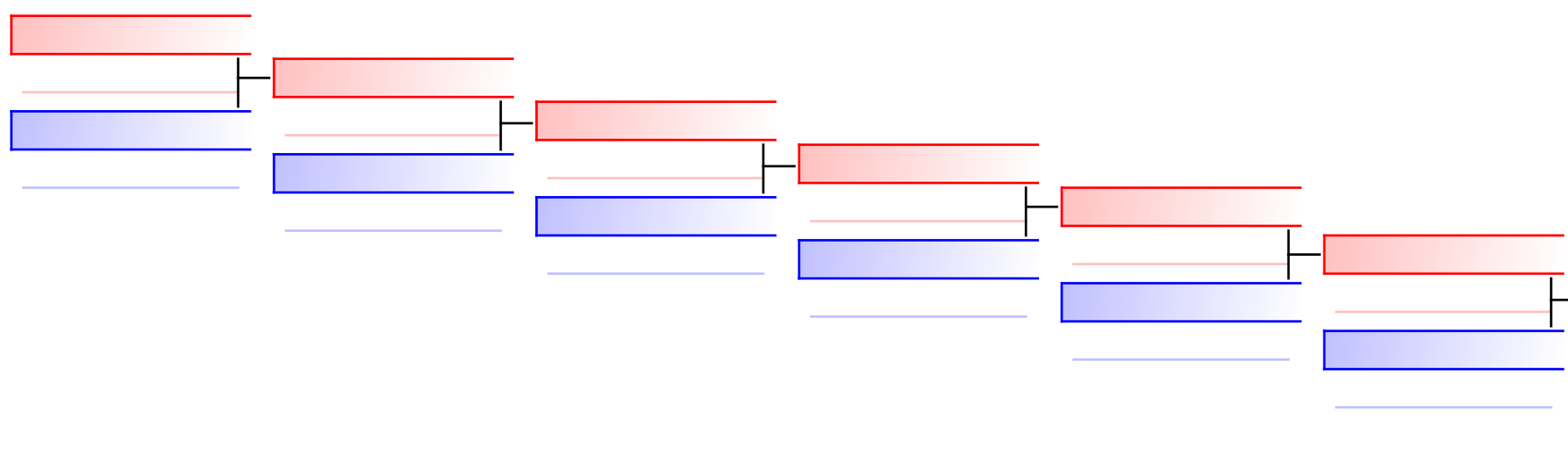

Sarti Alberto (Costa Azzurra) 0
 Mastria Lorenzo (UPP) 1

Referees:							
-----------	--	--	--	--	--	--	--

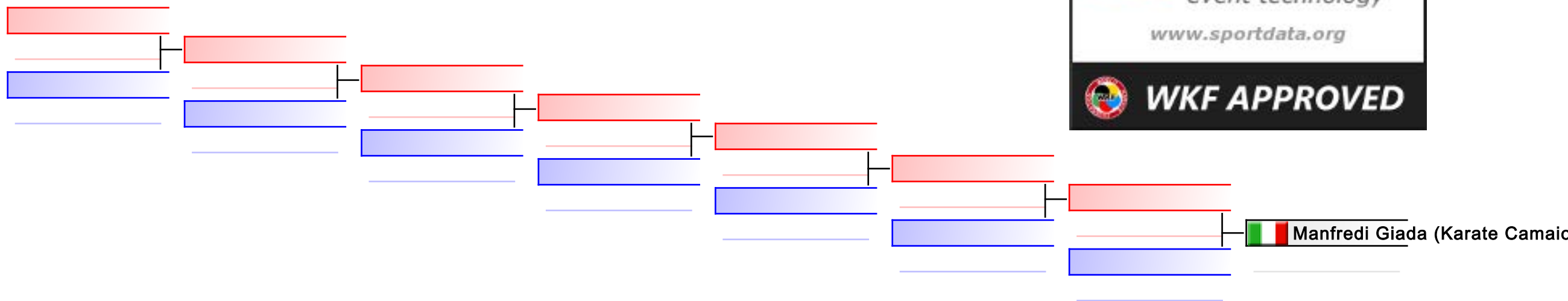

REPECHAGE: Kata F Assoluti(1)

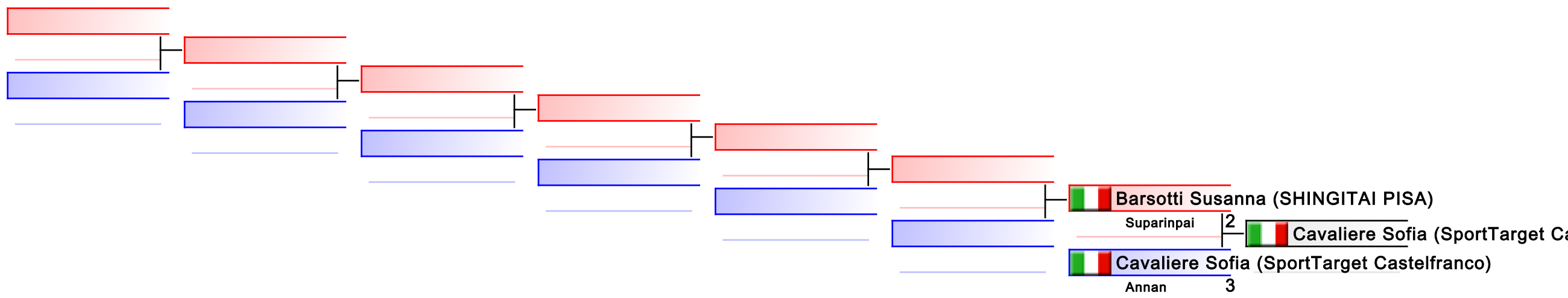

Referees:							
-----------	--	--	--	--	--	--	--

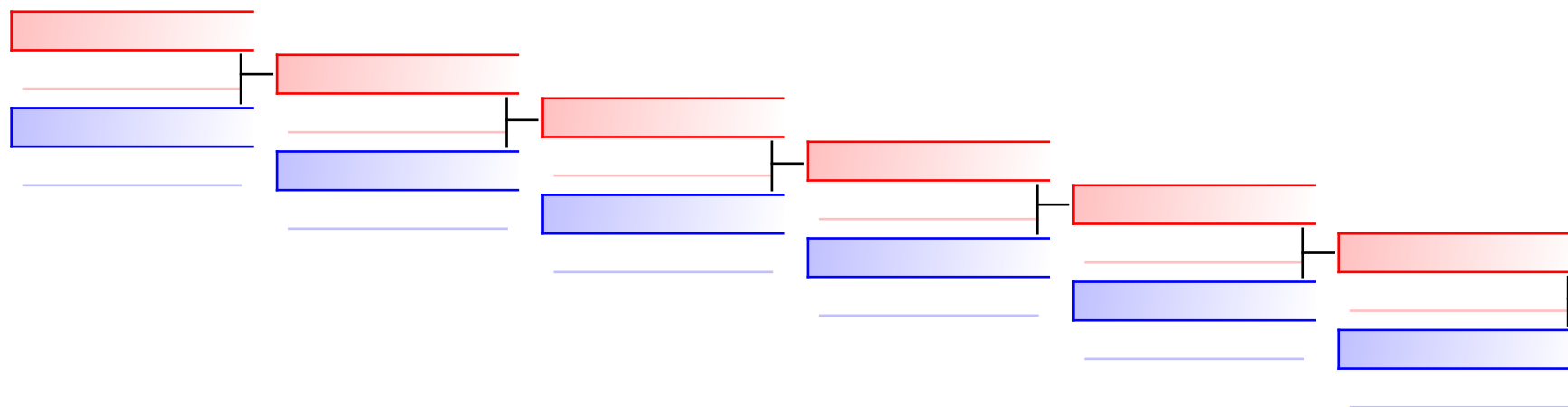

Pontremolesi Rebecca (AKS)
 Suparinpai 4
Pontremolesi Rebecca (AKS)
Alushi Debora (OMNISPORT GAMBASSI)
 Unshu 1

REPECHAGE: Kata F Cad(1)

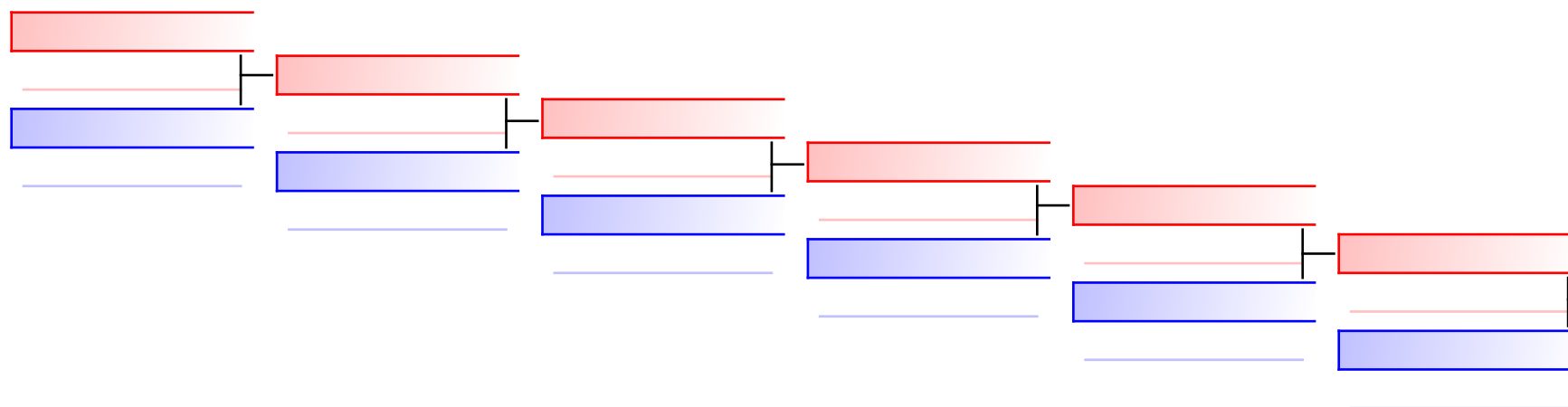

Gronchi Asia (SHINGITAI PISA)
 Suparinpai 2
Franchini Elisa (Centro Karate P)
Franchini Elisa (Centro Karate Riccione)
 Annan 3

Referees:							
-----------	--	--	--	--	--	--	--

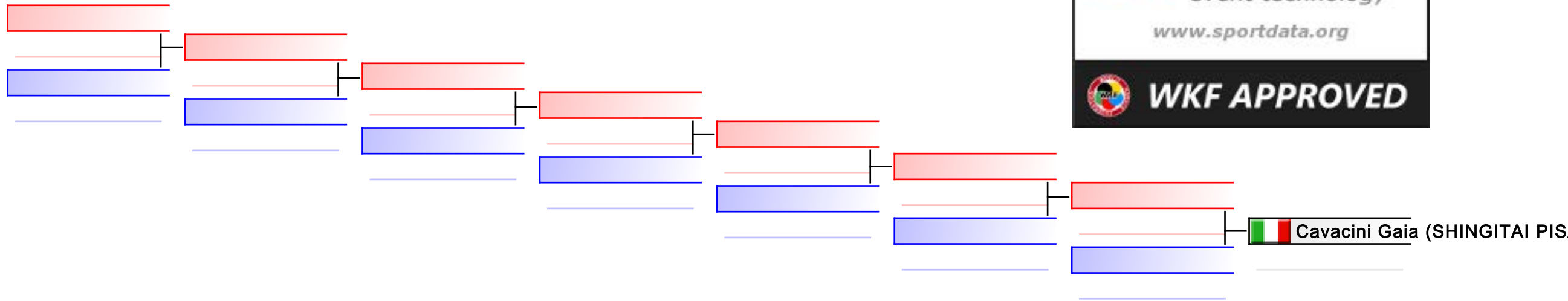

REPECHAGE: Kata F Es.B(1)

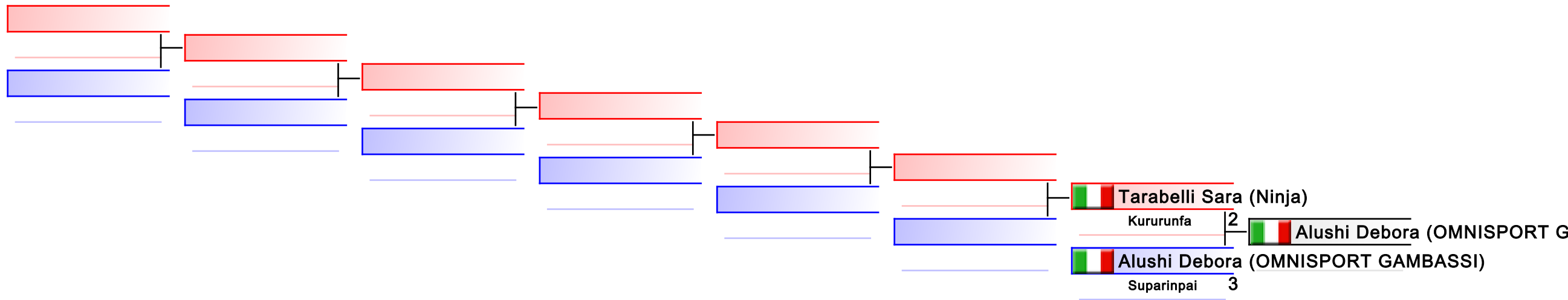

Referees:							
-----------	--	--	--	--	--	--	--

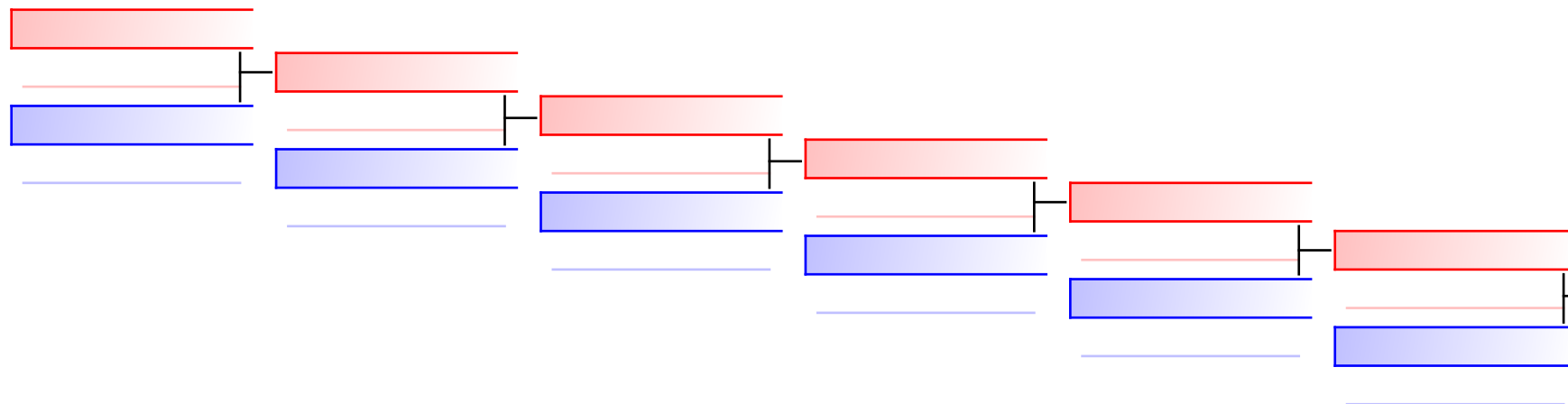

BENEDETTI MARIA (Karate Camaio)
Chatanyara Ku4
 BENEDETTI MARIA (Karate Camaio)
 Barsotti Susanna (SHINGITAI PISA)
Annan 1

REPECHAGE: Kata F Juniores(1)

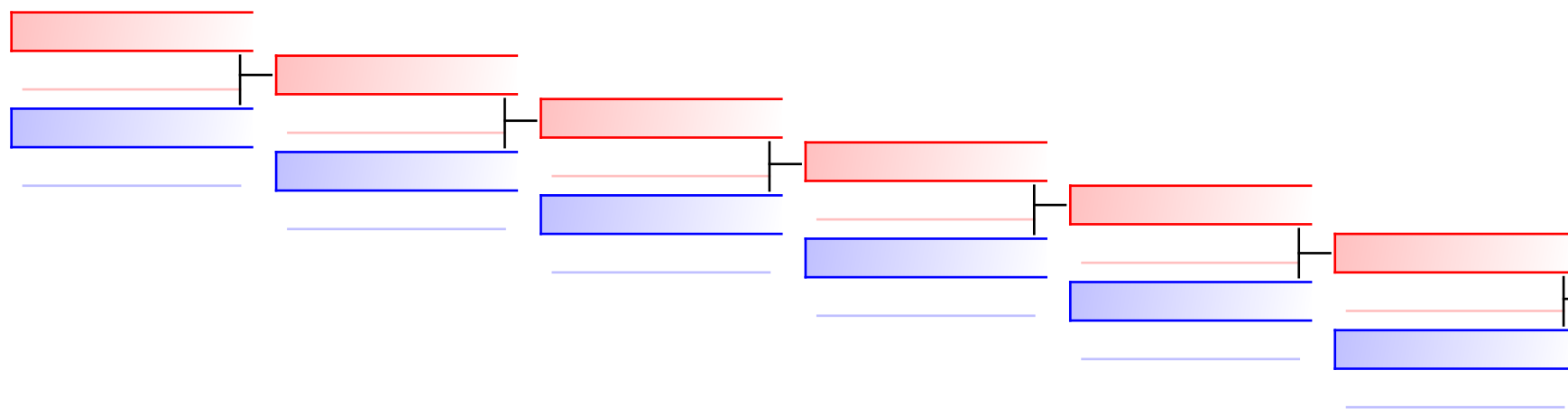

Cavaliere Sofia (SportTarget Castelfranco)
Paiku 2
 Gronchi Asia (SHINGITAI PISA)
 Gronchi Asia (SHINGITAI PISA)
Suparinpai 3

Referees:							
-----------	--	--	--	--	--	--	--

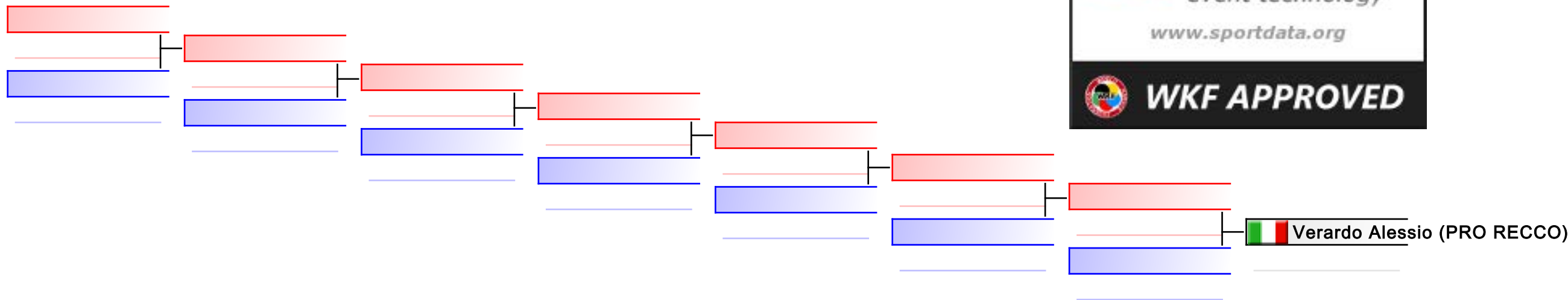

REPECHAGE: Kata M Assoluti(1)

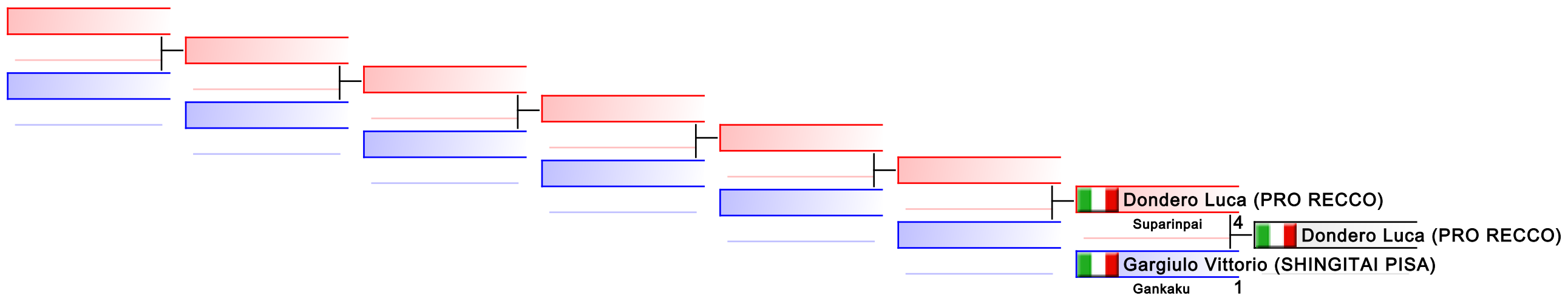

Referees:							
-----------	--	--	--	--	--	--	--

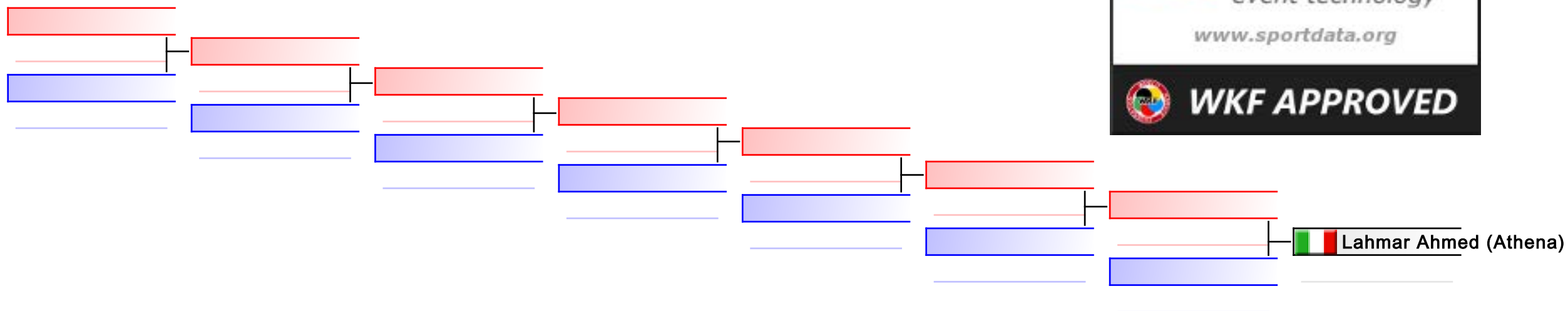

REPECHAGE: Kata M Cad(1)

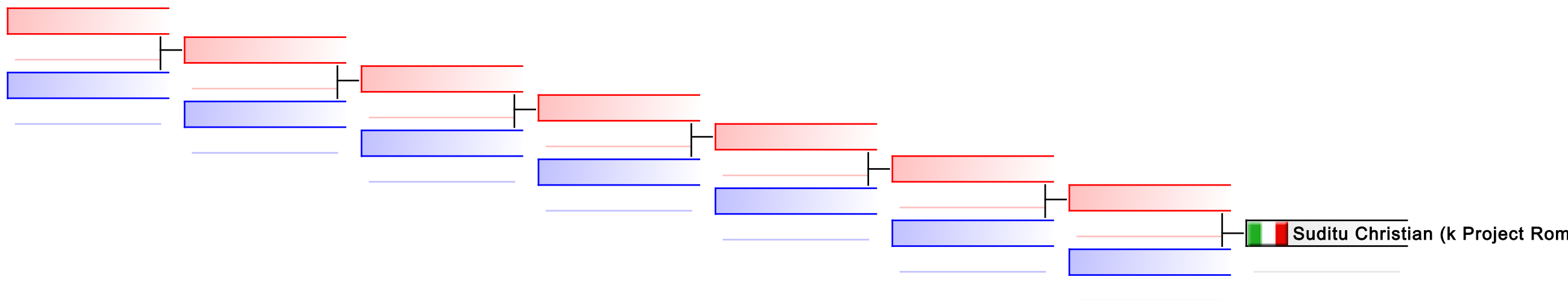

Referees:							
-----------	--	--	--	--	--	--	--

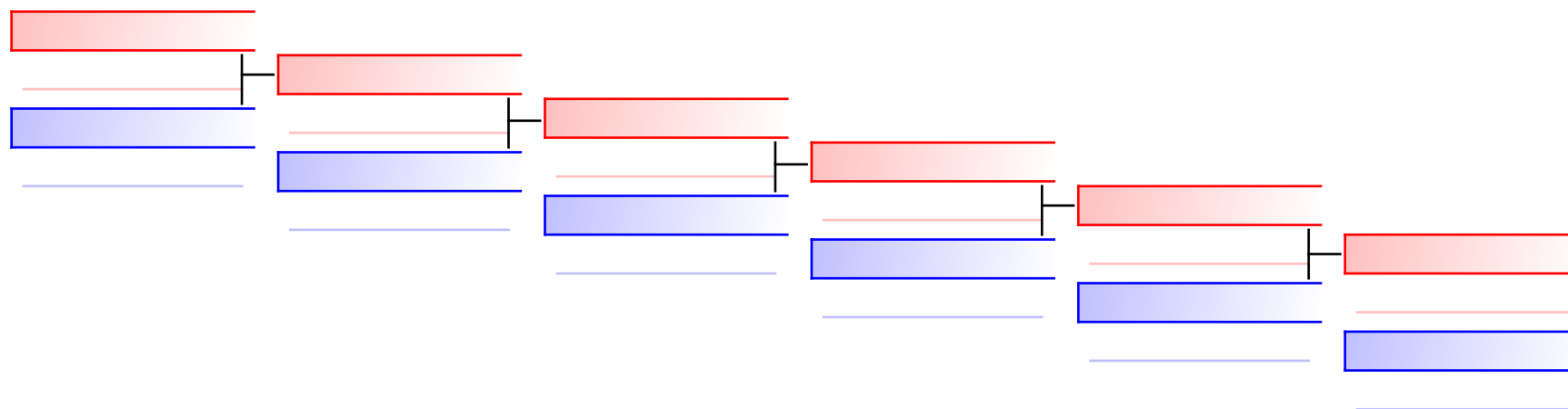

Samarughi Tommaso (k Project Roma)
Empi 4

Samarughi Tommaso (k Project Roma)
Suparinpai 1

Boetti Francesco (AKS)
Suparinpai 1

REPECHAGE: Kata M Es.A(1)

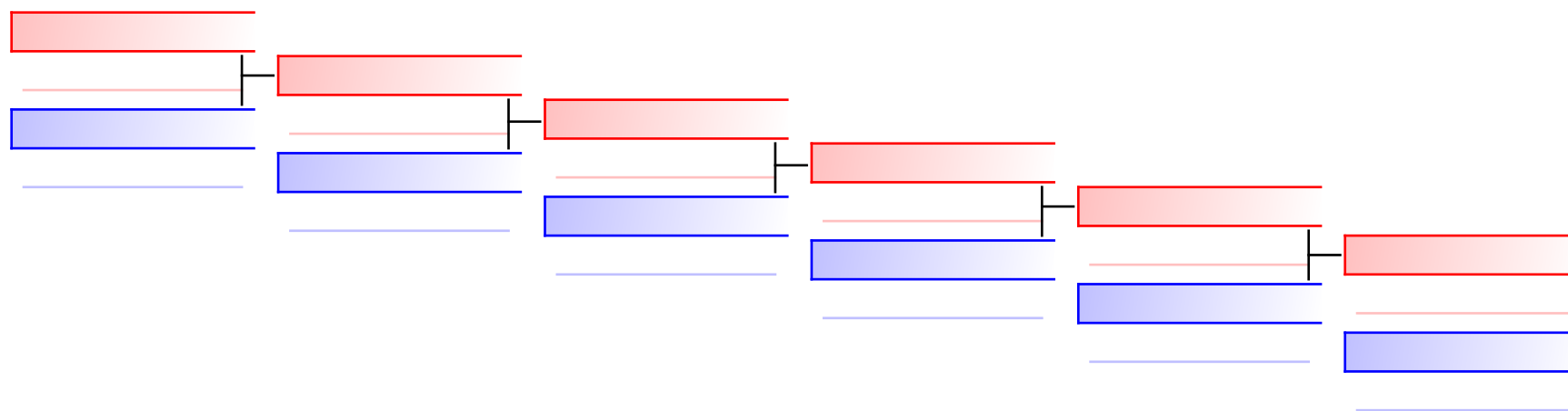





Michelotti Massimo (Ninja)
Paiku 5

Michelotti Massimo (Ninja)
Chatanyara Ku.0

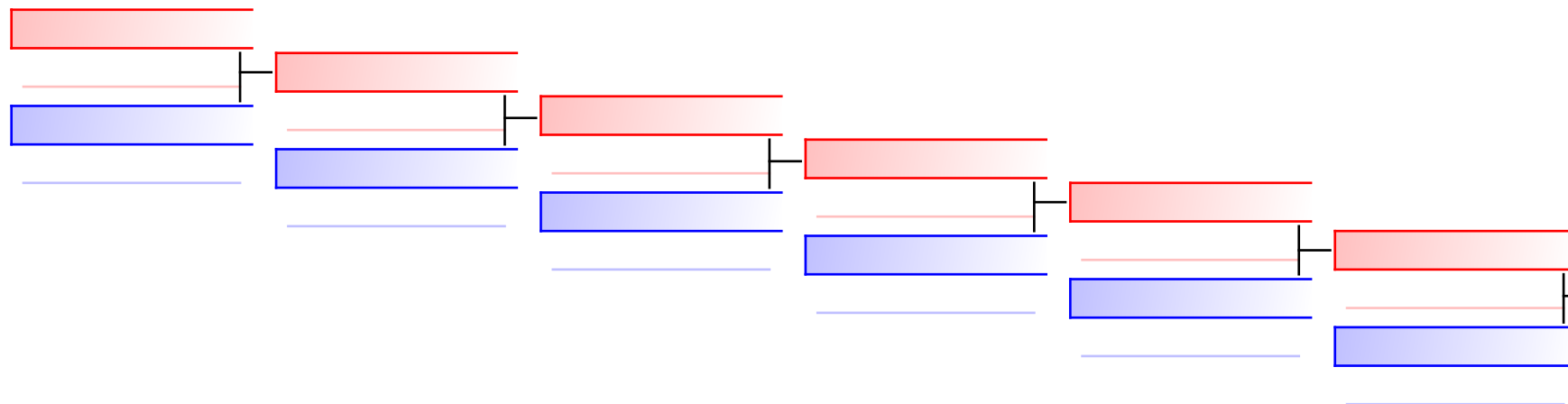
Fassone Filippo (PRO RECCO)
Chatanyara Ku.0

Referees:							
-----------	--	--	--	--	--	--	--



-  **Corona Mattia (Karate Camaiore)**
Goju Shiho Sh.4
-  **Corona Mattia (Karate Camaiore)**
-  **Ongarato Andrea (SportTarget Castelfranco)**
Goju Shiho Da. 1

REPECHAGE: Kata M Es.B(1)

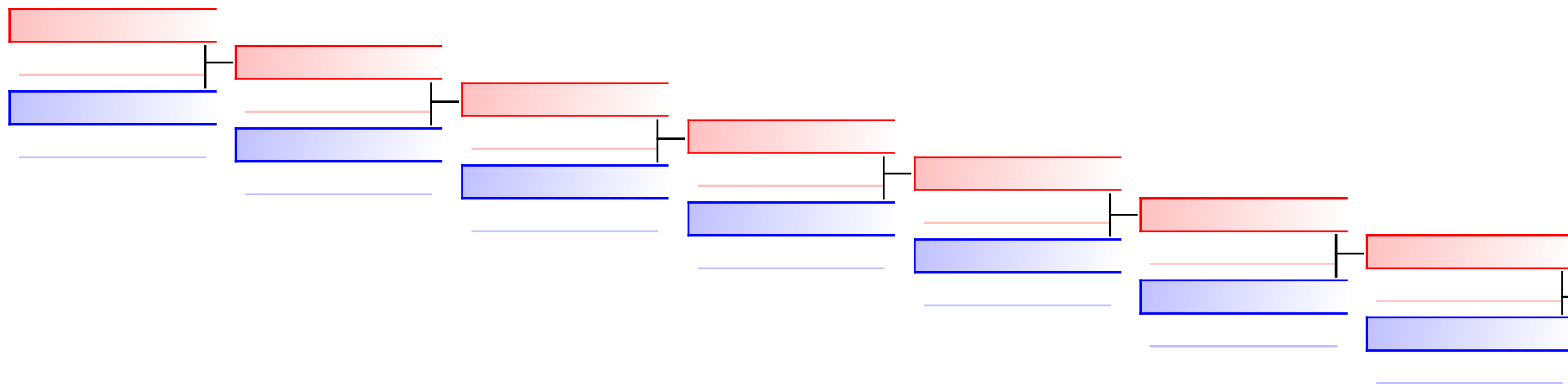

-  **Durastanti Edoardo (k Project F)**

Referees:							
-----------	--	--	--	--	--	--	--

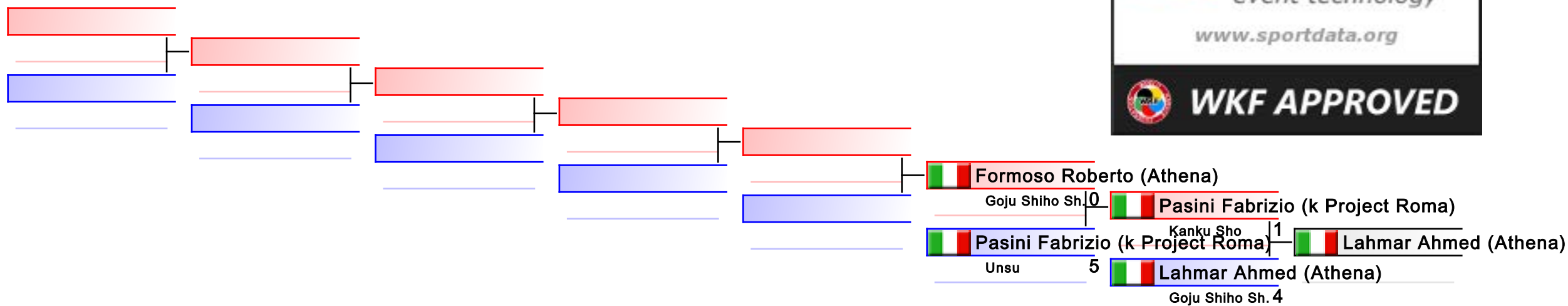

REPECHAGE: Kata M Juniores(1)

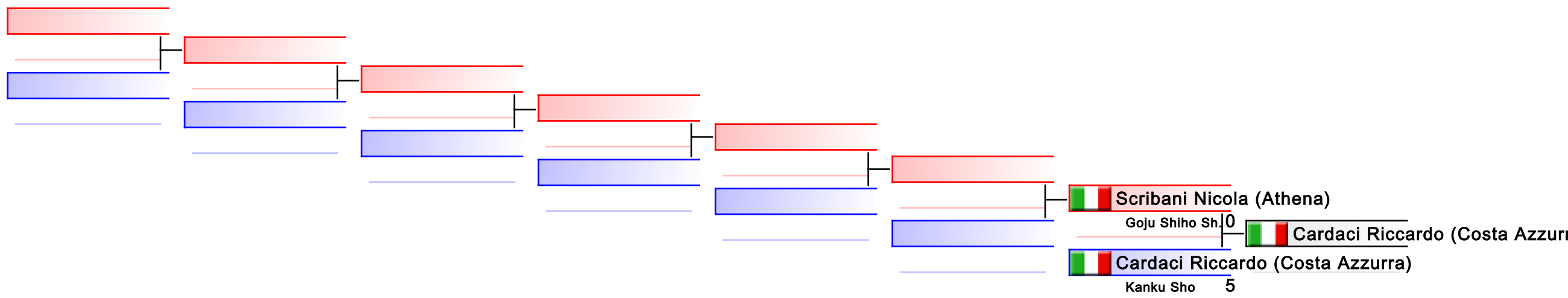

Referees:							
-----------	--	--	--	--	--	--	--

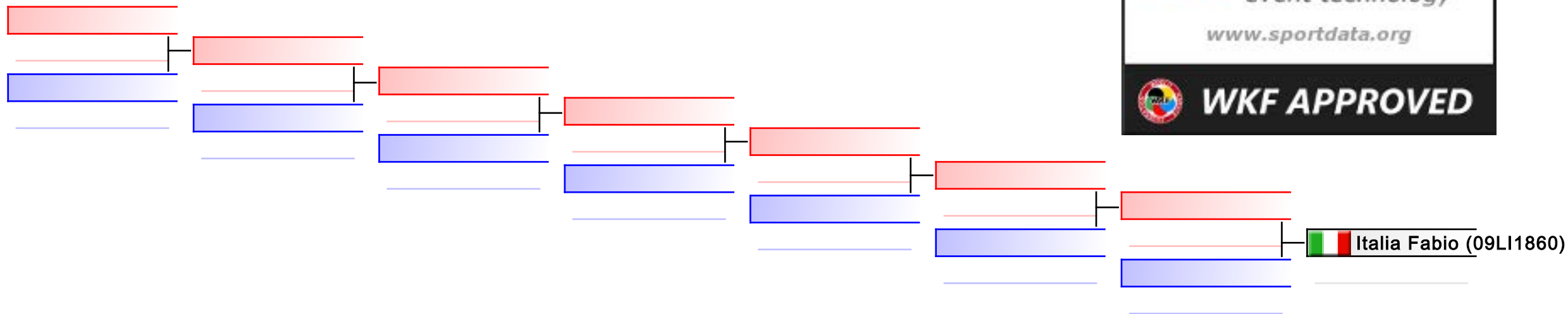

REPECHAGE: Kata M MAS35(1)

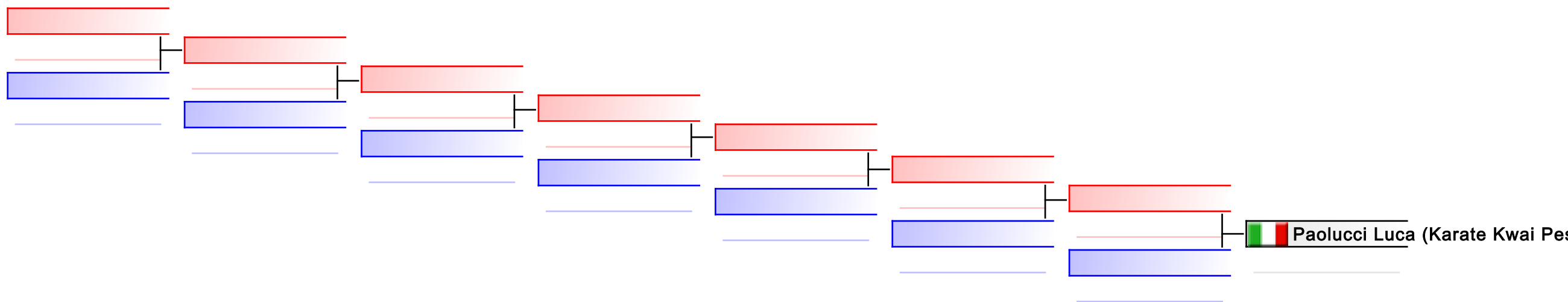

Referees:							
-----------	--	--	--	--	--	--	--

Kumite F CAD 59 Kg



Trofeo Toscana Primavera

(c)sportdata GmbH & Co KG 2000-2015(2015-04-27 10:12) -WKF Approved- v 8.4.0 build 1 License: FIJLKAM 2015 (expire 2015-12-31)

Tatami
3

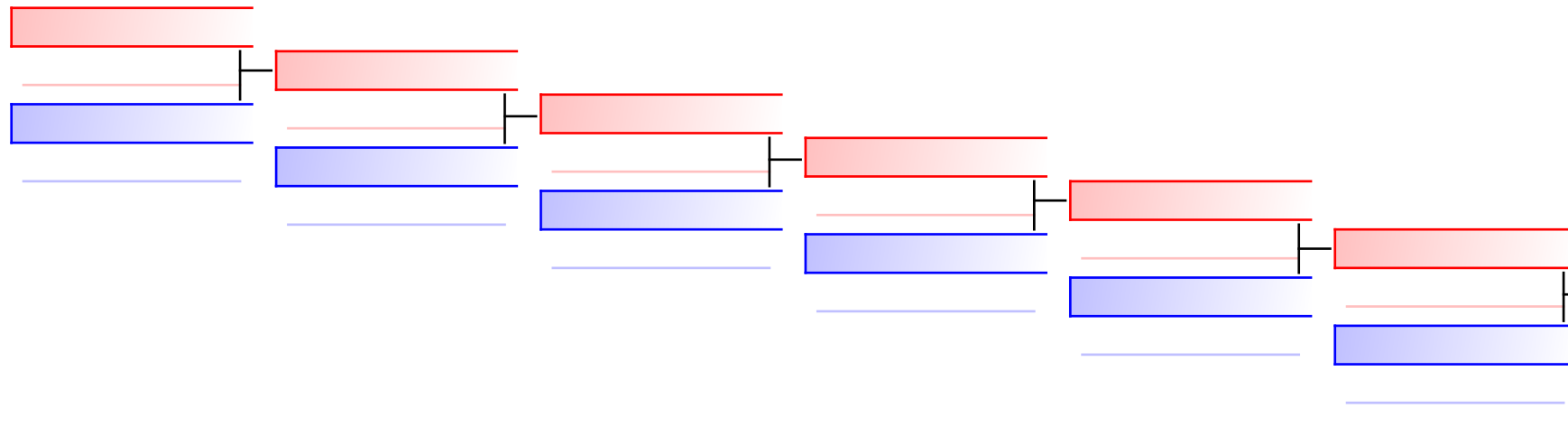
Pool
1



 Raffaelli Erika (SKF)
3
 Raffaelli Erika (SKF)
 Barnini Ambra (OMNISPORT GAMBASSI)
0

REPECHAGE: Kumite F CAD 59 Kg(1)

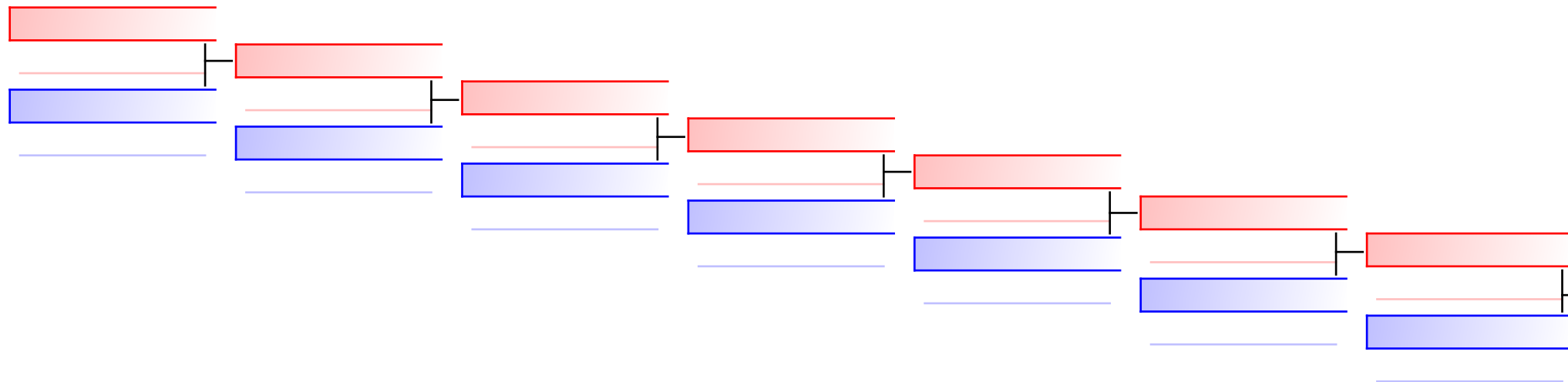

 Pannini Emanuela (MENS SAN)

Referees:							
-----------	--	--	--	--	--	--	--

Kumite F Es.A 32-37 Kg

Trofeo Toscana Primavera

(c)sportdata GmbH & Co KG 2000-2015(2015-04-27 10:12) -WKF Approved- v 8.4.0 build 1 License: FIJLKAM 2015 (expire 2015-12-31)

Tatami
2

Pool
1

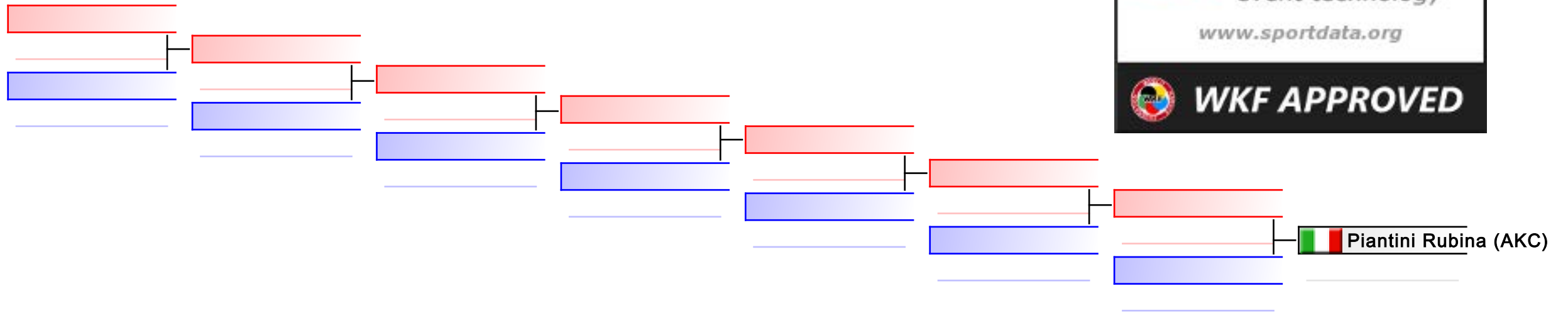

REPECHAGE: Kumite F Es.A 32-37 Kg(1)

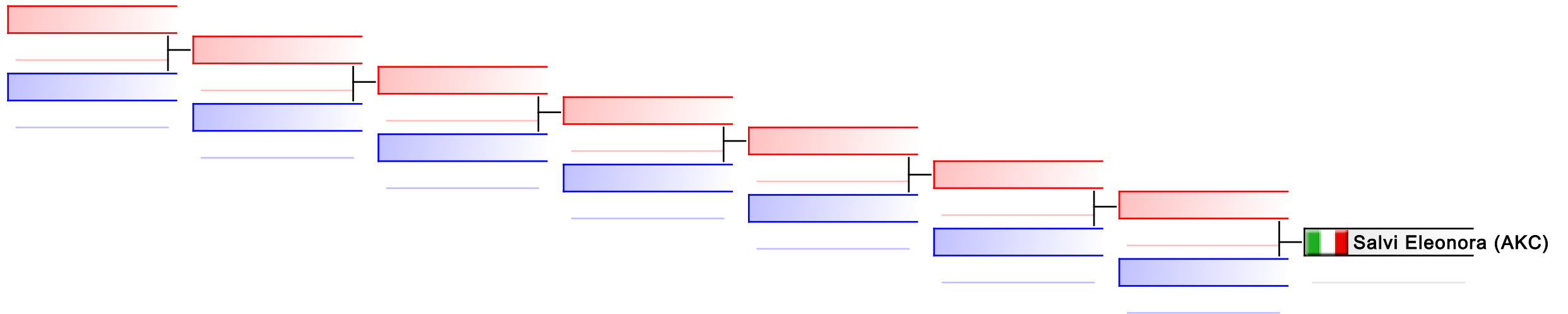

Referees:							
-----------	--	--	--	--	--	--	--

Kumite F Es.A 47 Kg

Trofeo Toscana Primavera

(c)sportdata GmbH & Co KG 2000-2015(2015-04-27 10:12) -WKF Approved- v 8.4.0 build 1 License: FIJLKAM 2015 (expire 2015-12-31)

Tatami
1

Pool
1

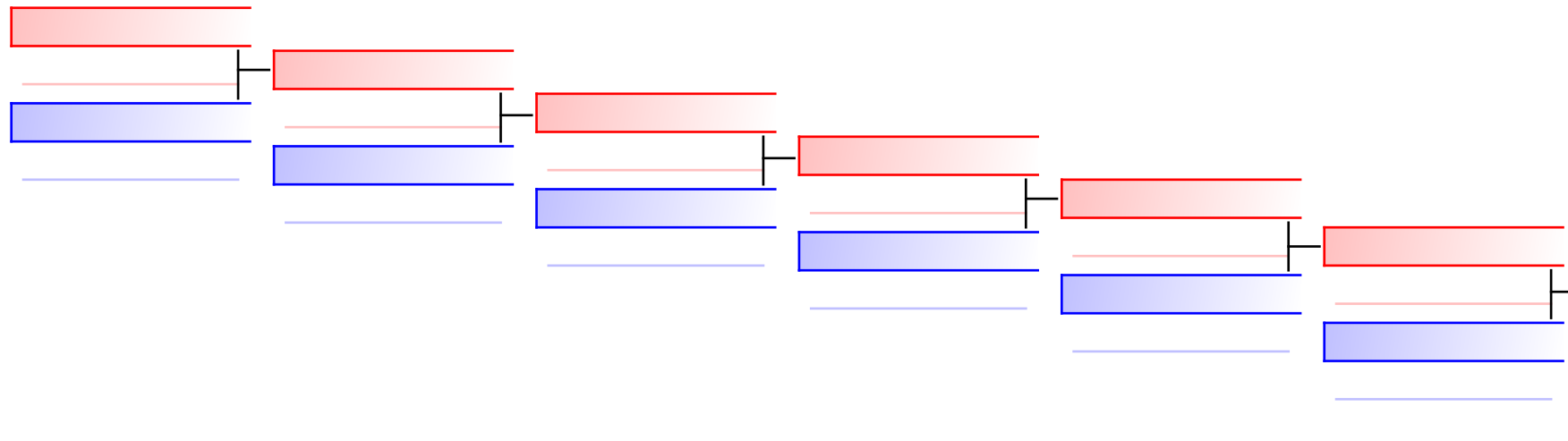

 **Bellinelli Melania (Bodymind Karate)**
 0
 **Bellinelli Melania (Bodymind Ka**
 0
 **Piparo Ludovica (SHINGITAI PISA)**
 0

REPECHAGE: Kumite F Es.A 47 Kg(1)

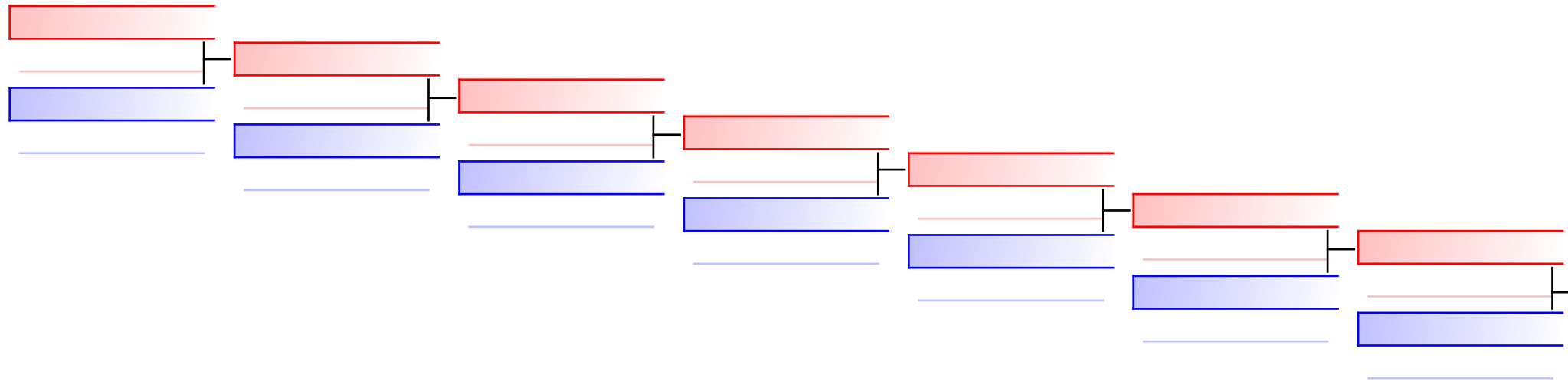

 **Franchini Martina (CKS Certald**

Referees:							
-----------	--	--	--	--	--	--	--

Kumite F JUN -50 Kg

Trofeo Toscana Primavera

(c)sportdata GmbH & Co KG 2000-2015(2015-04-27 10:12) -WKF Approved- v 8.4.0 build 1 License: FIJLKAM 2015 (expire 2015-12-31)

Tatami
4

Pool
1

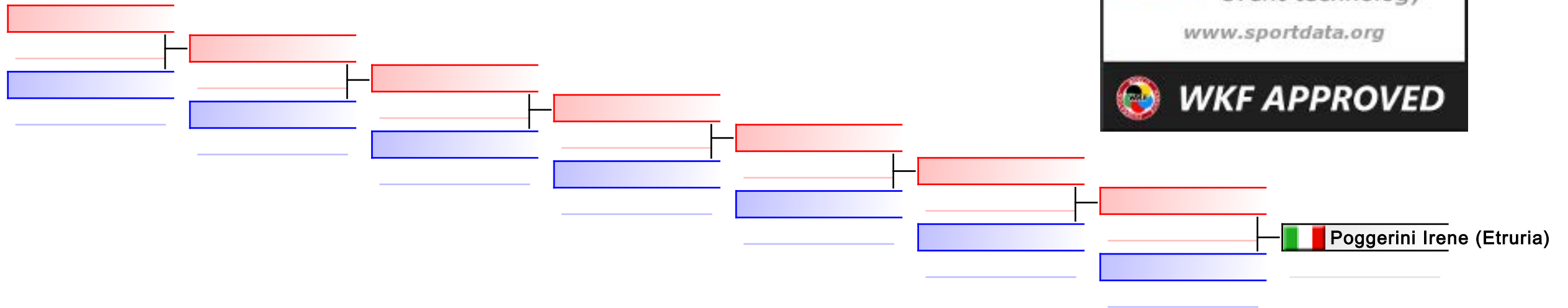

REPECHAGE: Kumite F JUN -50 Kg(1)

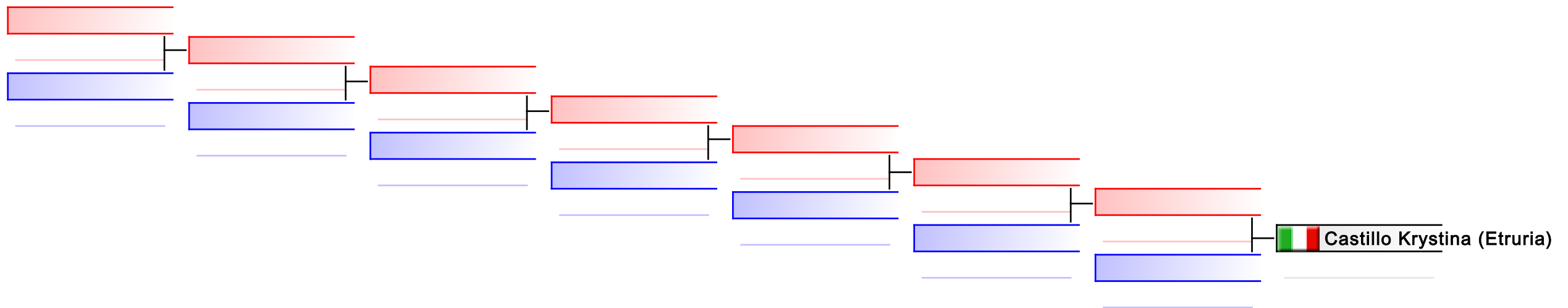

Referees:							
-----------	--	--	--	--	--	--	--

Kumite F JUN -61 Kg

Trofeo Toscana Primavera

(c)sportdata GmbH & Co KG 2000-2015(2015-04-27 10:12) -WKF Approved- v 8.4.0 build 1 License: FIJLKAM 2015 (expire 2015-12-31)

Tatami
2

Pool
1

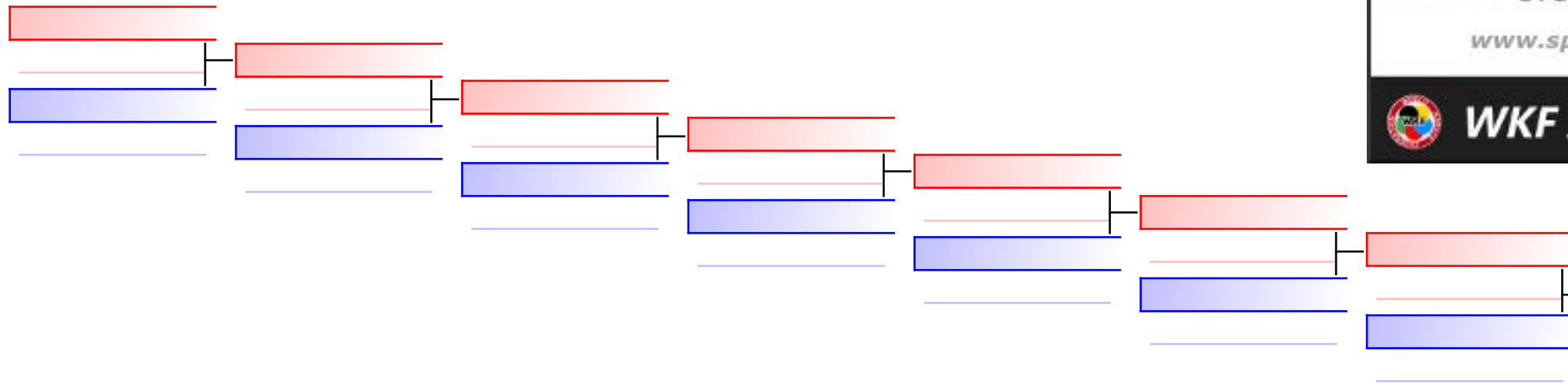

REPECHAGE: Kumite F JUN -61 Kg(1)

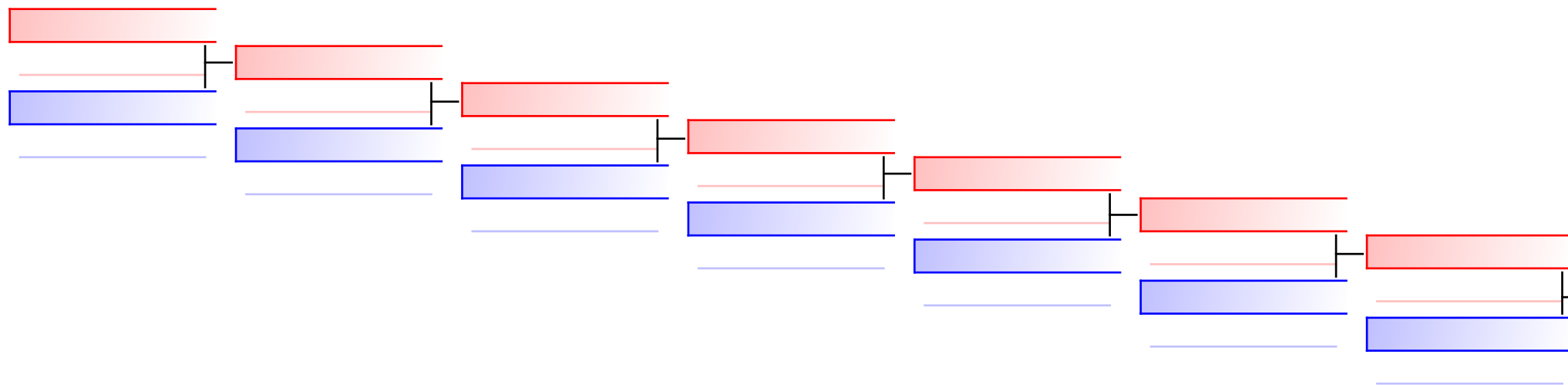

Referees:							
-----------	--	--	--	--	--	--	--

Kumite M CAD 61 Kg

Trofeo Toscana Primavera

(c)sportdata GmbH & Co KG 2000-2015(2015-04-27 10:12) -WKF Approved- v 8.4.0 build 1 License: FIJKAM 2015 (expire 2015-12-31)

Tatami
3

Pool
1

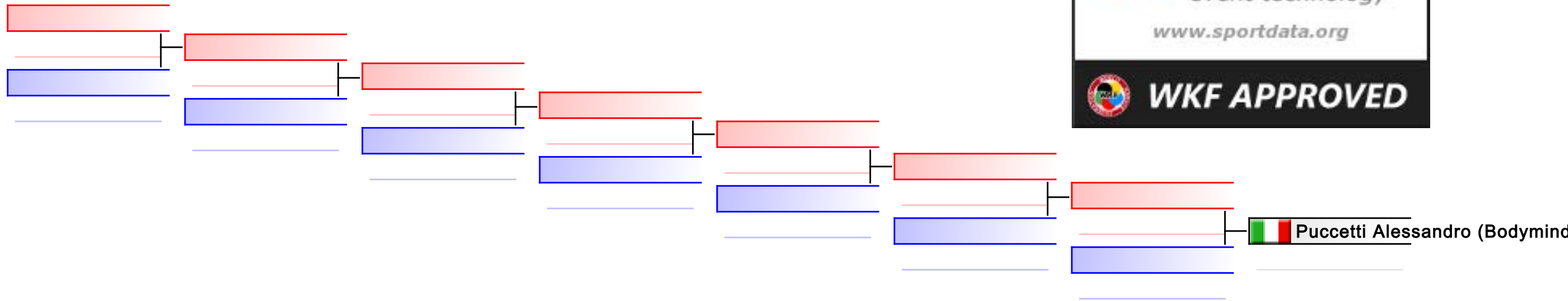

REPECHAGE: Kumite M CAD 61 Kg(1)

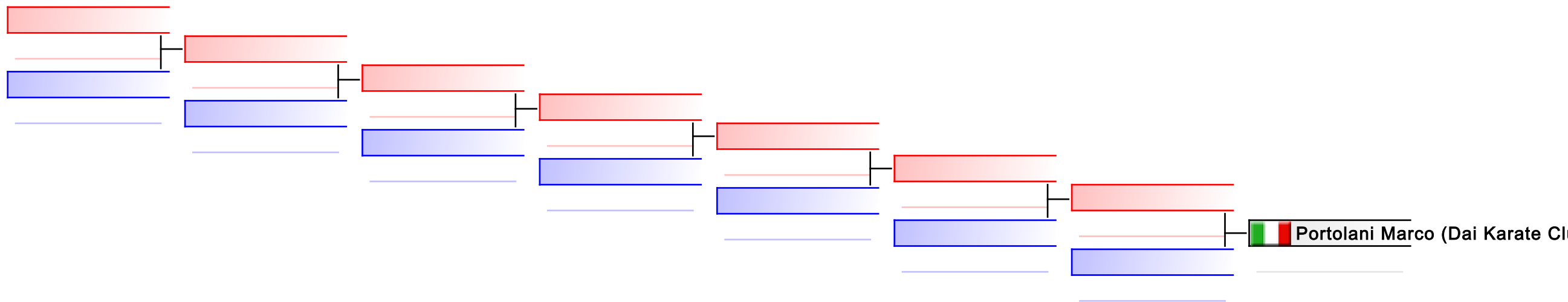

Referees:							
-----------	--	--	--	--	--	--	--

Kumite M CAD 68 Kg

Trofeo Toscana Primavera

(c)sportdata GmbH & Co KG 2000-2015(2015-04-27 10:12) -WKF Approved- v 8.4.0 build 1 License: FIJLKAM 2015 (expire 2015-12-31)

Tatami
2

Pool
1

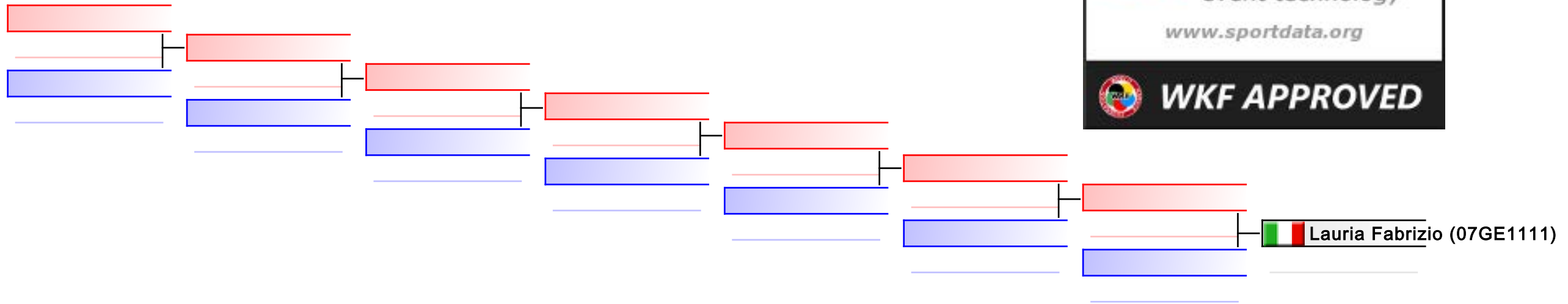

REPECHAGE: Kumite M CAD 68 Kg(1)

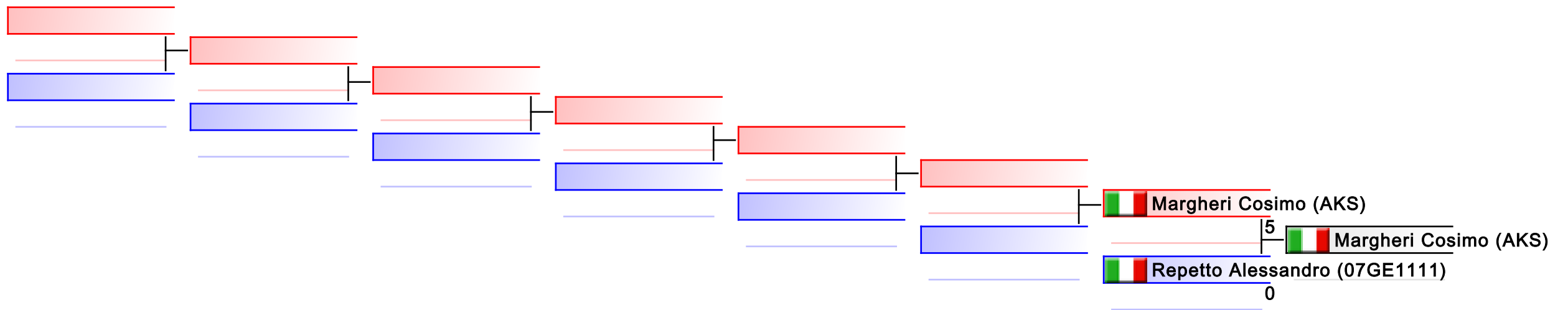

Referees:							
-----------	--	--	--	--	--	--	--

Kumite M CAD 76 Kg

Trofeo Toscana Primavera

(c)sportdata GmbH & Co KG 2000-2015(2015-04-27 10:12) -WKF Approved- v 8.4.0 build 1 License: FIJLKAM 2015 (expire 2015-12-31)

Tatami
1

Pool
1

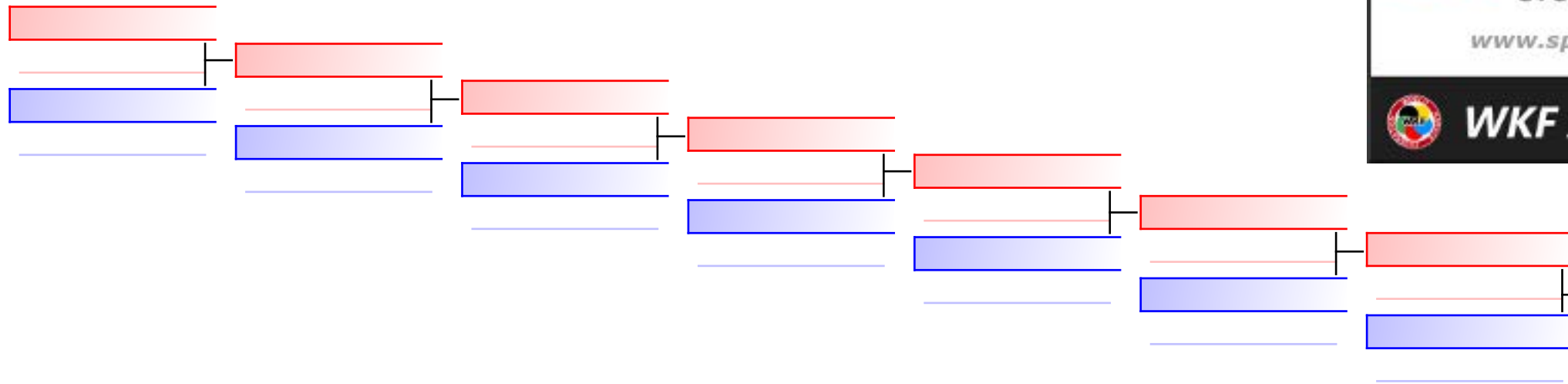

REPECHAGE: Kumite M CAD 76 Kg(1)

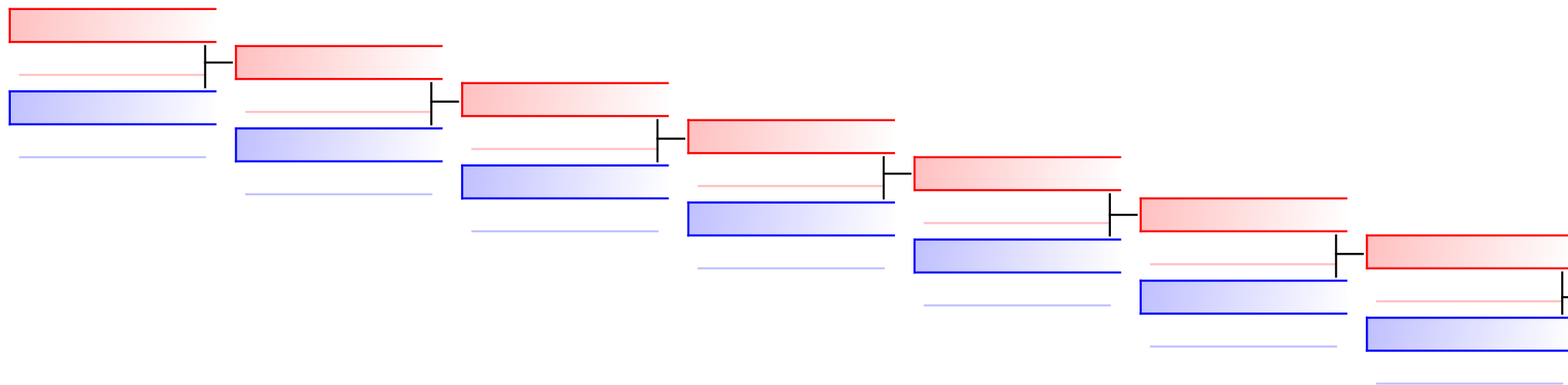

Referees:							
-----------	--	--	--	--	--	--	--

Kumite M Es.A 35-40 Kg

Trofeo Toscana Primavera

(c)sportdata GmbH & Co KG 2000-2015(2015-04-27 10:12) -WKF Approved- v 8.4.0 build 1 License: FIJKAM 2015 (expire 2015-12-31)

Tatami
4

Pool
1

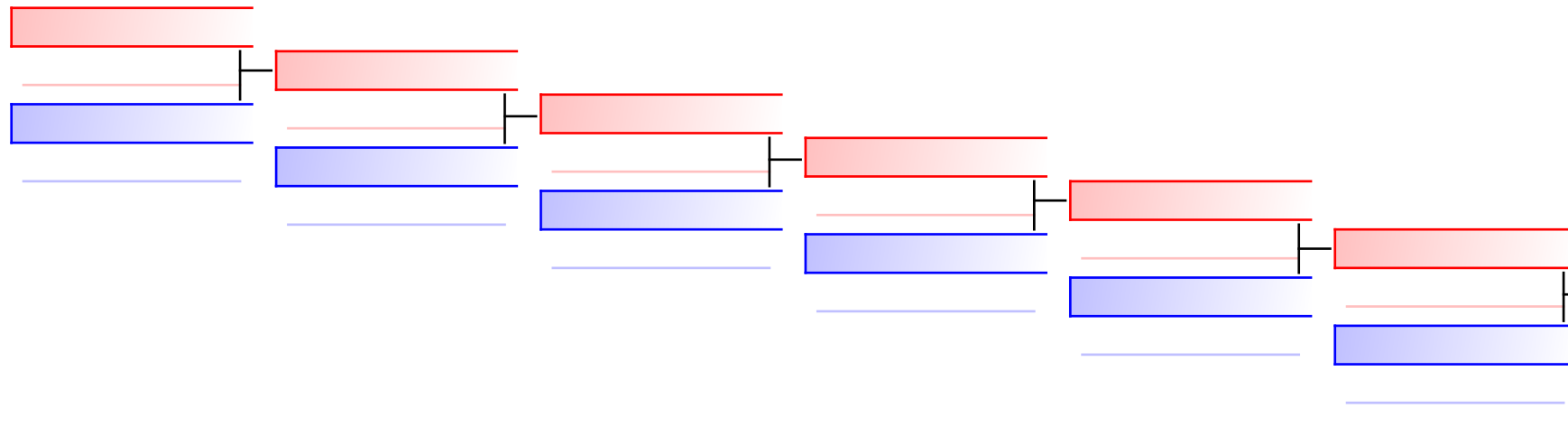

Fedi Davide (Ninja)
0
 Balleggi Lorenzo (Athena)
0

REPECHAGE: Kumite M Es.A 35-40 Kg(1)

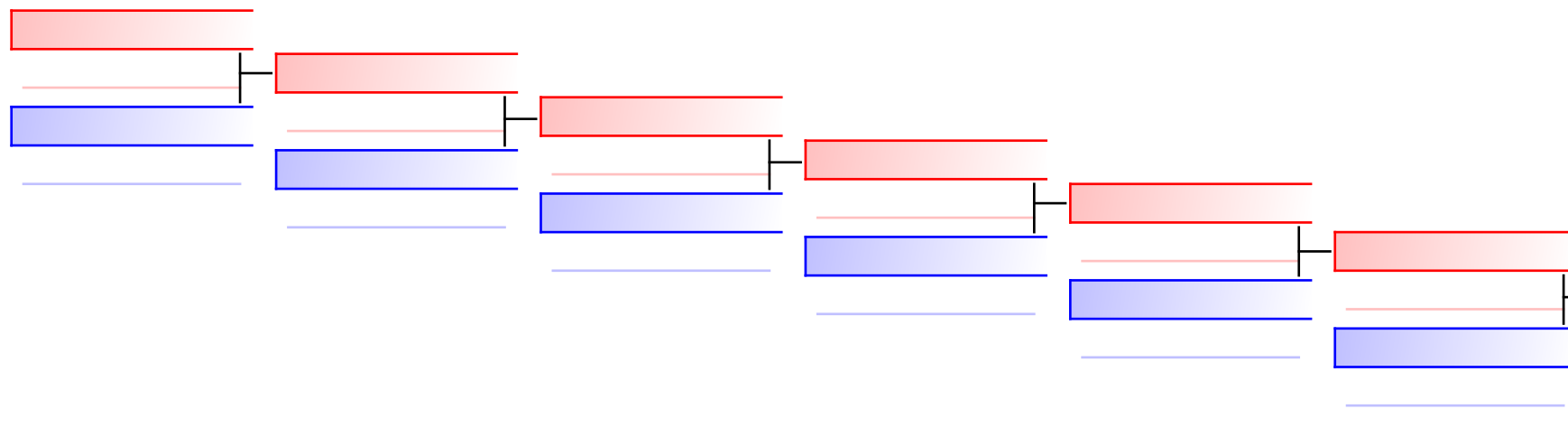

Pizzo Gabriele (Bushido Lucca)
 Dini Emanuele (Bodymind Kara)
 Dini Emanuele (Bodymind Karate)

Referees:							
-----------	--	--	--	--	--	--	--

Kumite M Es.A 45 Kg

Trofeo Toscana Primavera

(c)sportdata GmbH & Co KG 2000-2015(2015-04-27 10:12) -WKF Approved- v 8.4.0 build 1 License: FIJLKAM 2015 (expire 2015-12-31)

Tatami
3

Pool
1

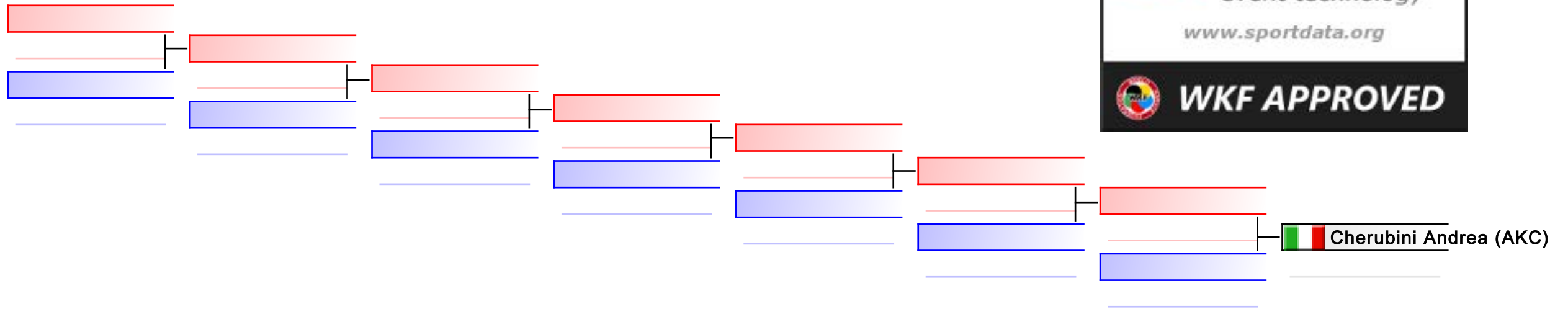

REPECHAGE: Kumite M Es.A 45 Kg(1)

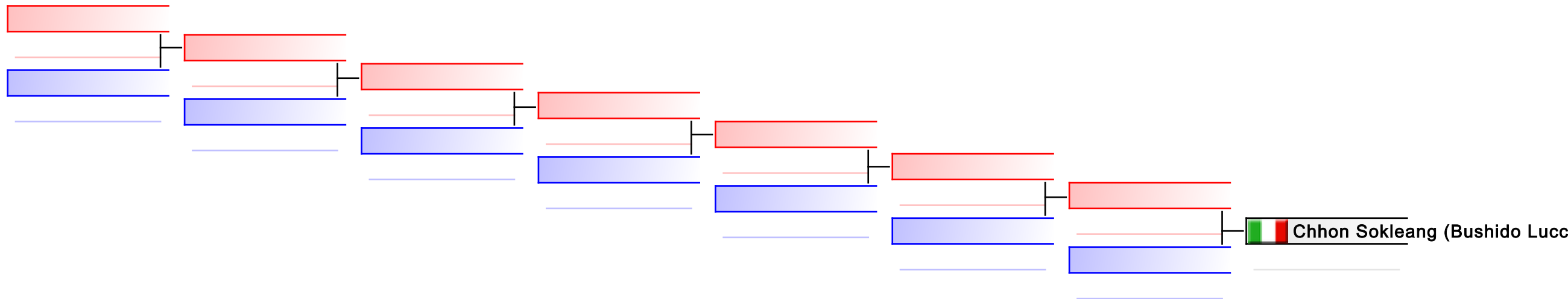

Referees:							
-----------	--	--	--	--	--	--	--

Kumite M Es.A 50 Kg

Trofeo Toscana Primavera

(c)sportdata GmbH & Co KG 2000-2015(2015-04-27 10:12) -WKF Approved- v 8.4.0 build 1 License: FIJLKAM 2015 (expire 2015-12-31)

Tatami
3

Pool
1

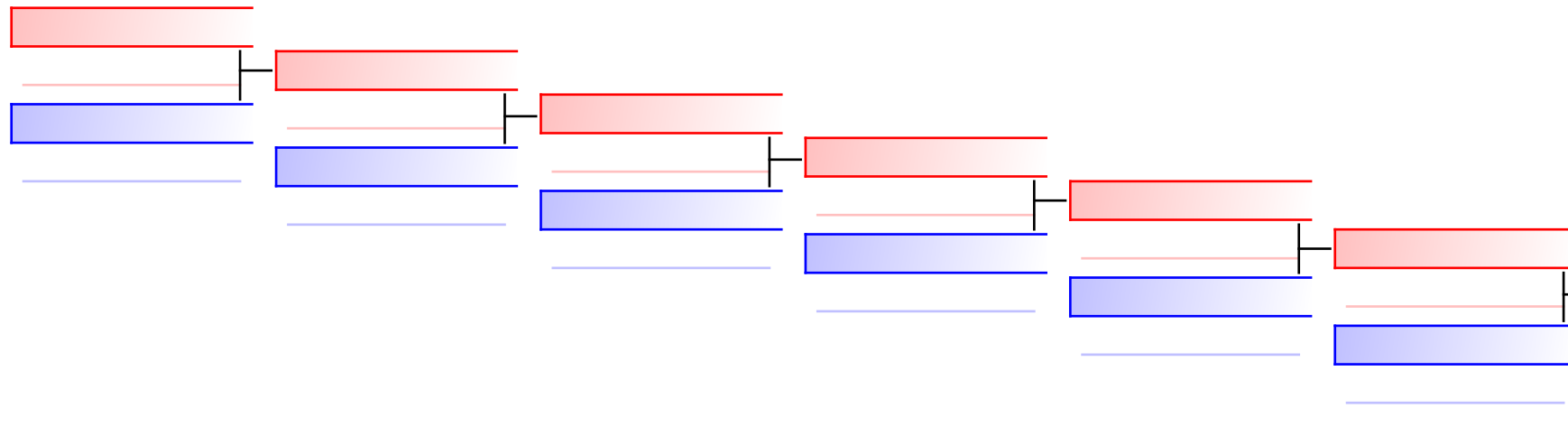

Ciuffardi Andrea (Bushido Lucca)
3
 Ciuffardi Andrea (Bushido Lucca)
 Del_Carlo Lorenzo (Bodymind Karate)
0

REPECHAGE: Kumite M Es.A 50 Kg(1)

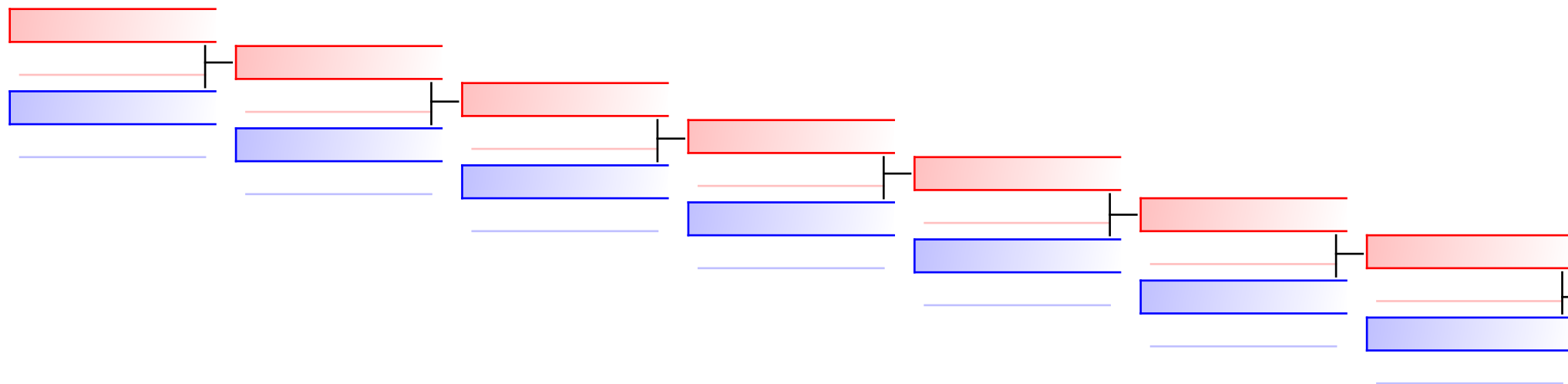

Moranti Riccardo (Bodymind Ka)

Referees:							
-----------	--	--	--	--	--	--	--

Kumite M Es.A 61 Kg

Trofeo Toscana Primavera

(c)sportdata GmbH & Co KG 2000-2015(2015-04-27 10:12) -WKF Approved- v 8.4.0 build 1 License: FIJLKAM 2015 (expire 2015-12-31)

Tatami
2

Pool
1

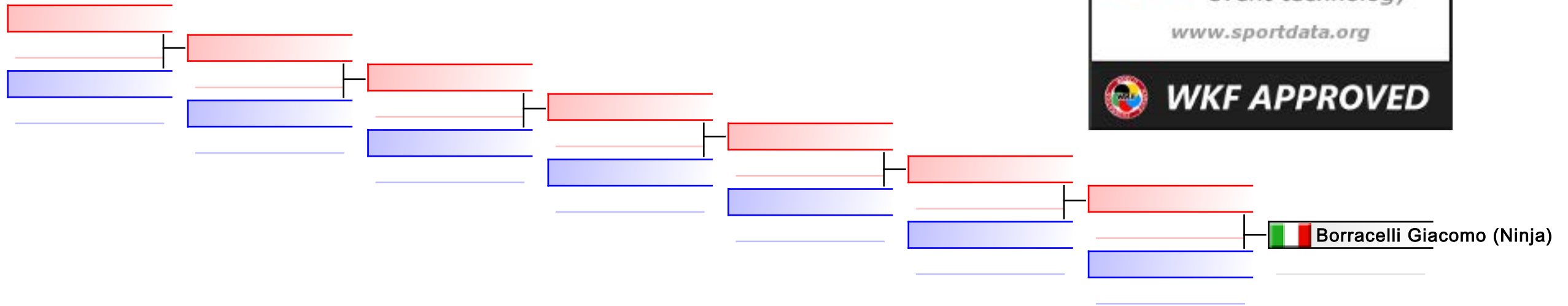

REPECHAGE: Kumite M Es.A 61 Kg(1)

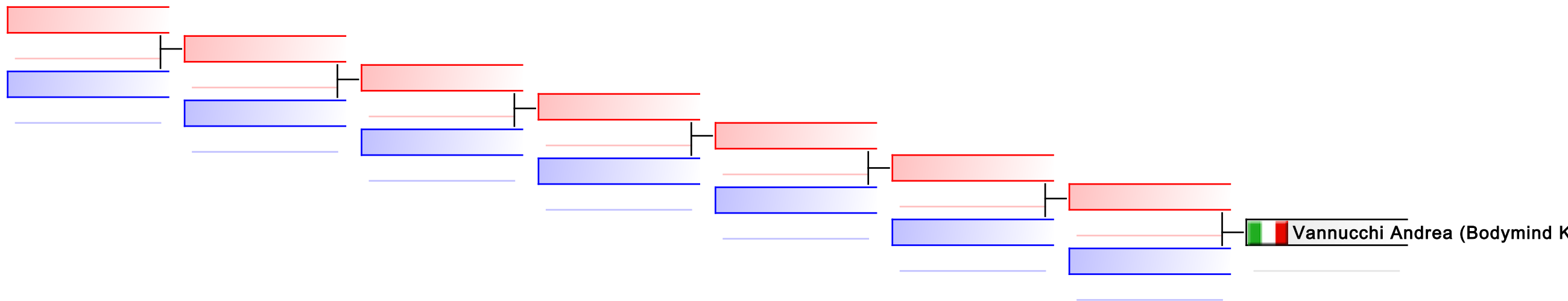

Referees:							
-----------	--	--	--	--	--	--	--

Kumite M Es.B 57 Kg

Trofeo Toscana Primavera

(c)sportdata GmbH & Co KG 2000-2015(2015-04-27 10:12) -WKF Approved- v 8.4.0 build 1 License: FIJLKAM 2015 (expire 2015-12-31)

Tatami
1

Pool
1

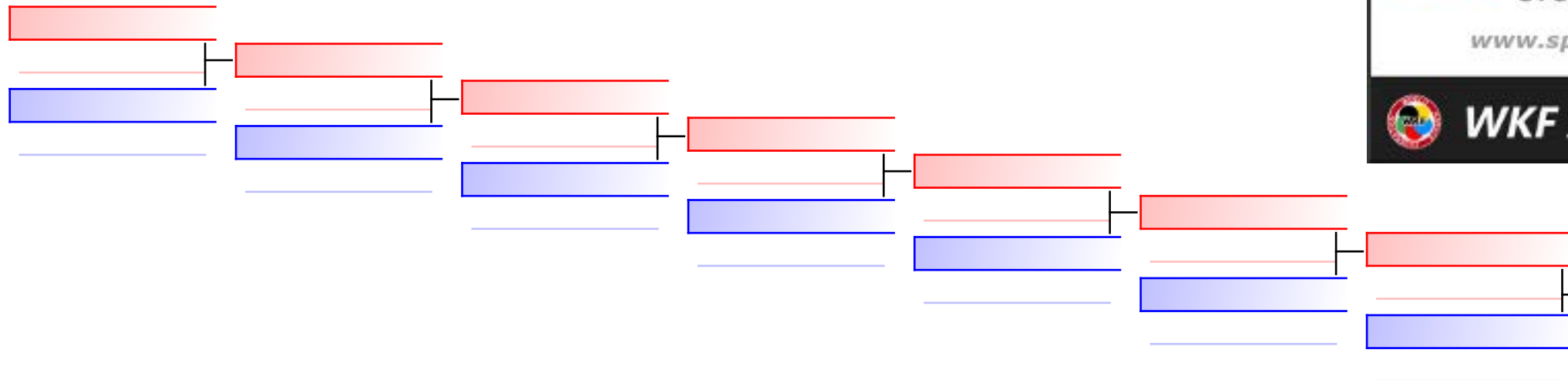

 Ciampalini Andrea (CKS Certale)

REPECHAGE: Kumite M Es.B 57 Kg(1)

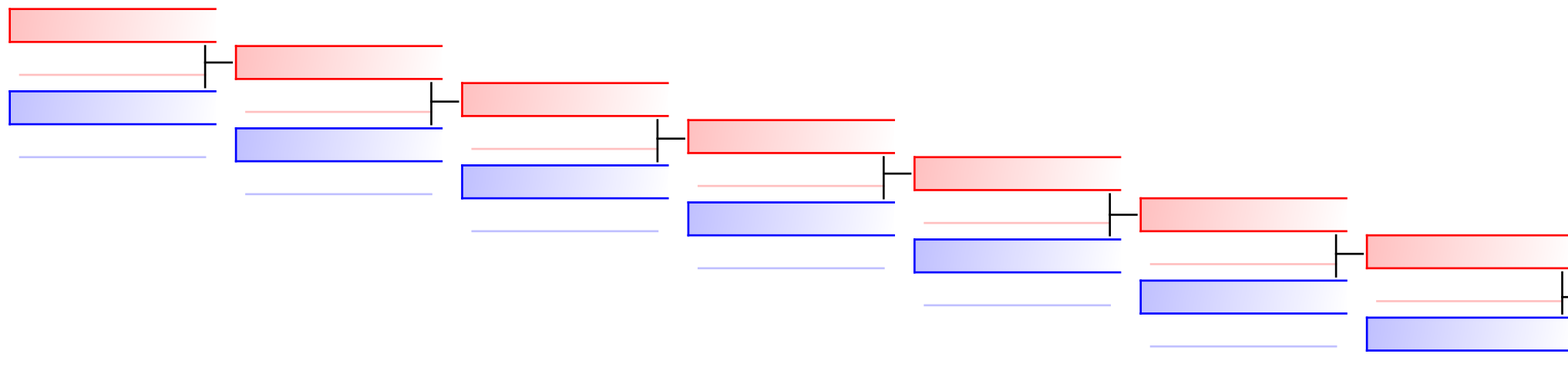

 Bazzani Francesco (CKS Certale)

Referees:							
-----------	--	--	--	--	--	--	--

Kumite M Es.B 70 Kg

Trofeo Toscana Primavera

(c)sportdata GmbH & Co KG 2000-2015(2015-04-27 10:12) -WKF Approved- v 8.4.0 build 1 License: FIJLKAM 2015 (expire 2015-12-31)

Tatami
2

Pool
1

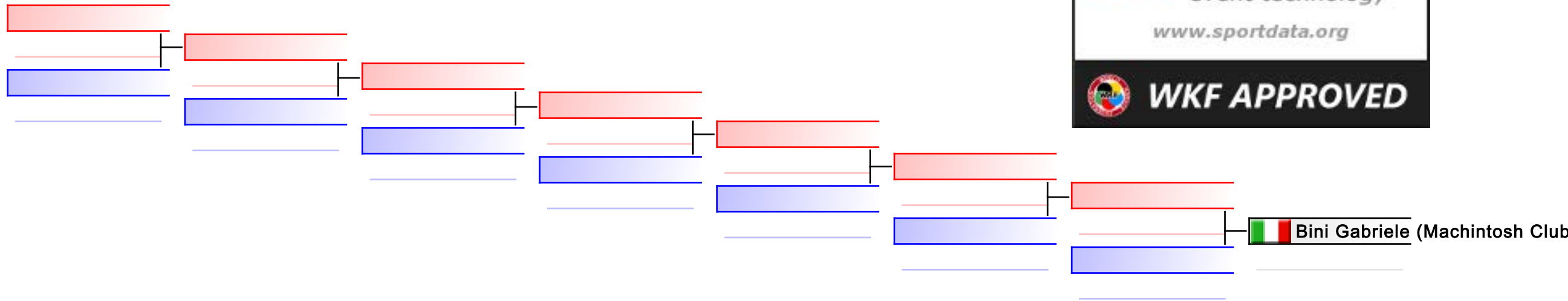

REPECHAGE: Kumite M Es.B 70 Kg(1)

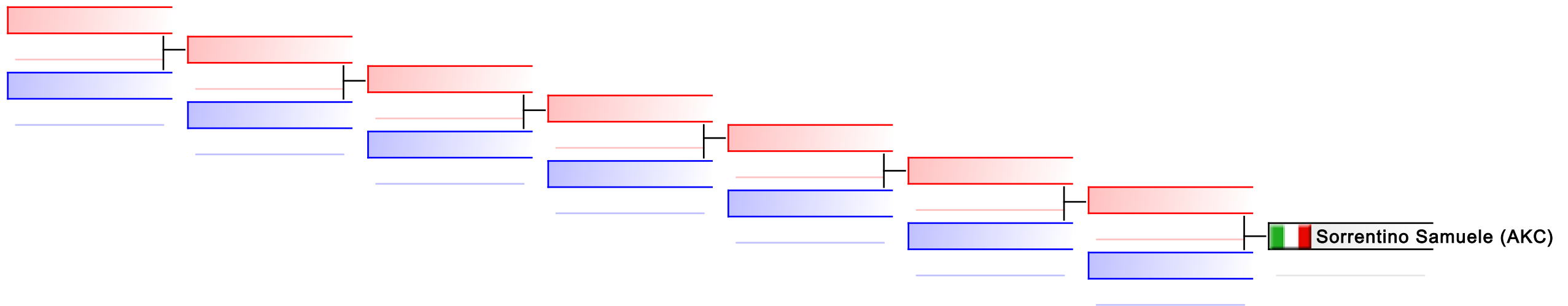

Referees:							
-----------	--	--	--	--	--	--	--

Kumite M JUN -60 Kg

Trofeo Toscana Primavera

(c)sportdata GmbH & Co KG 2000-2015(2015-04-27 10:12) -WKF Approved- v 8.4.0 build 1 License: FIJLKAM 2015 (expire 2015-12-31)

Tatami
2

Pool
1

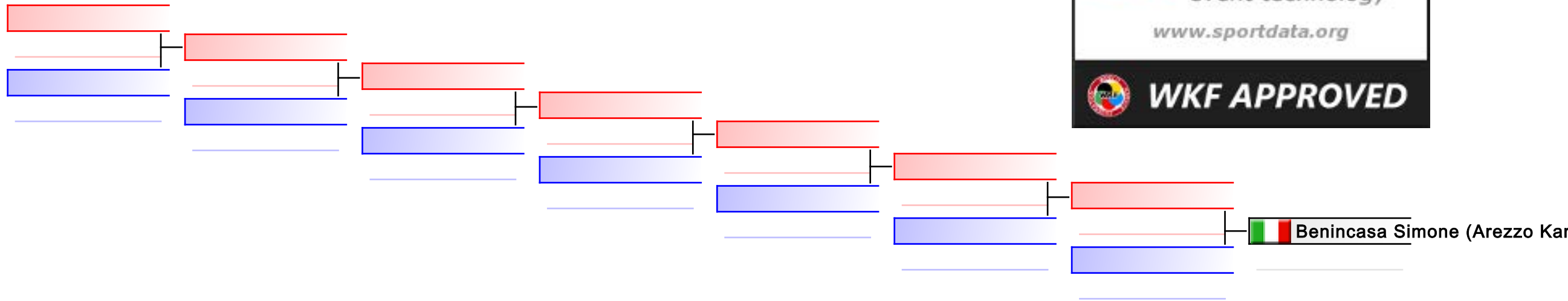

REPECHAGE: Kumite M JUN -60 Kg(1)

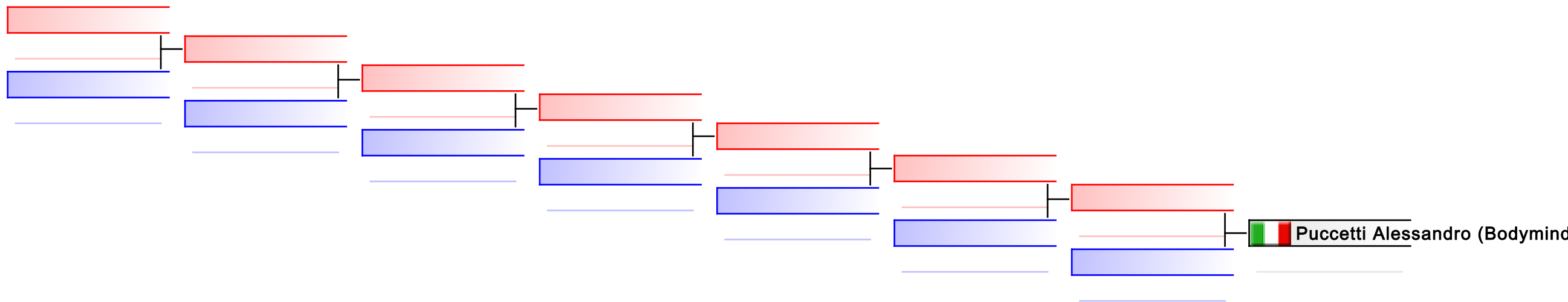

Referees:							
-----------	--	--	--	--	--	--	--

Kumite M MAS45 75Kg

Trofeo Toscana Primavera

(c)sportdata GmbH & Co KG 2000-2015(2015-04-27 10:12) -WKF Approved- v 8.4.0 build 1 License: FIJLKAM 2015 (expire 2015-12-31)

Tatami
3

Pool
1

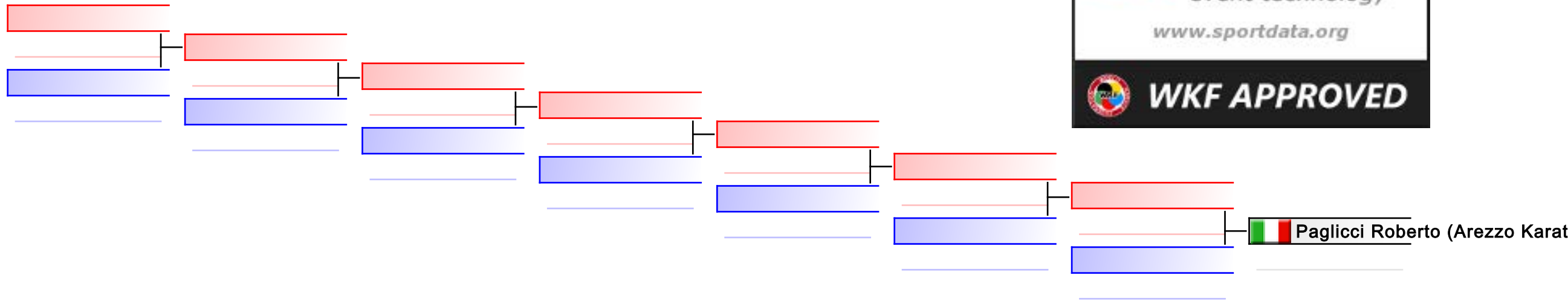

REPECHAGE: Kumite M MAS45 75Kg(1)

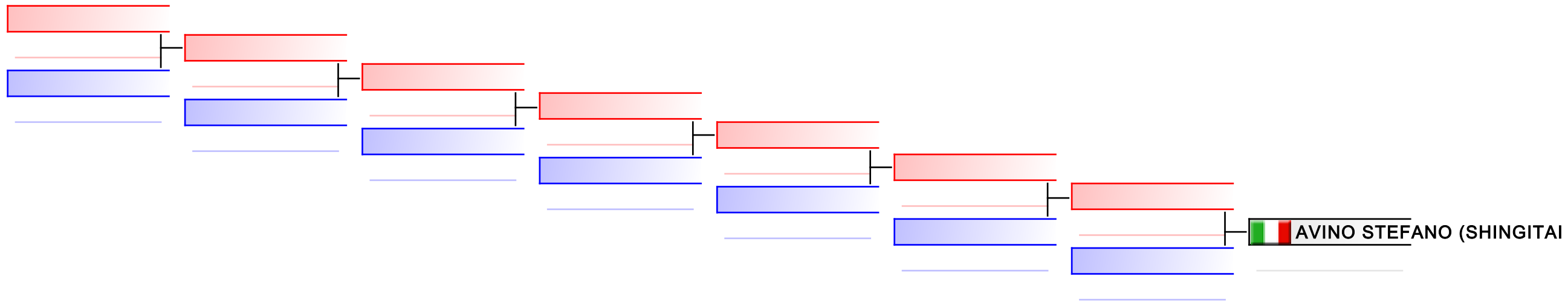

Referees:							
-----------	--	--	--	--	--	--	--

Kumite M SEN 55-60 Kg

Trofeo Toscana Primavera

(c)sportdata GmbH & Co KG 2000-2015(2015-04-27 10:12) -WKF Approved- v 8.4.0 build 1 License: FIJLKAM 2015 (expire 2015-12-31)

Tatami
4

Pool
1

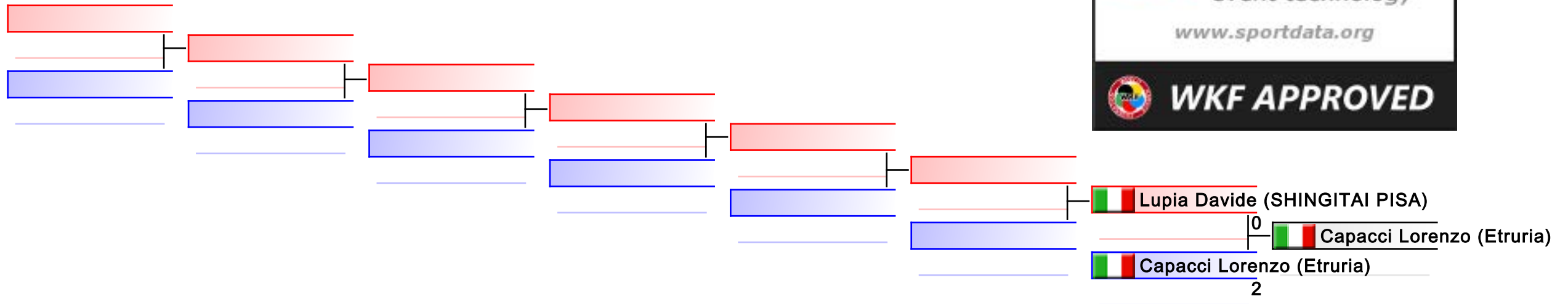

REPECHAGE: Kumite M SEN 55-60 Kg(1)

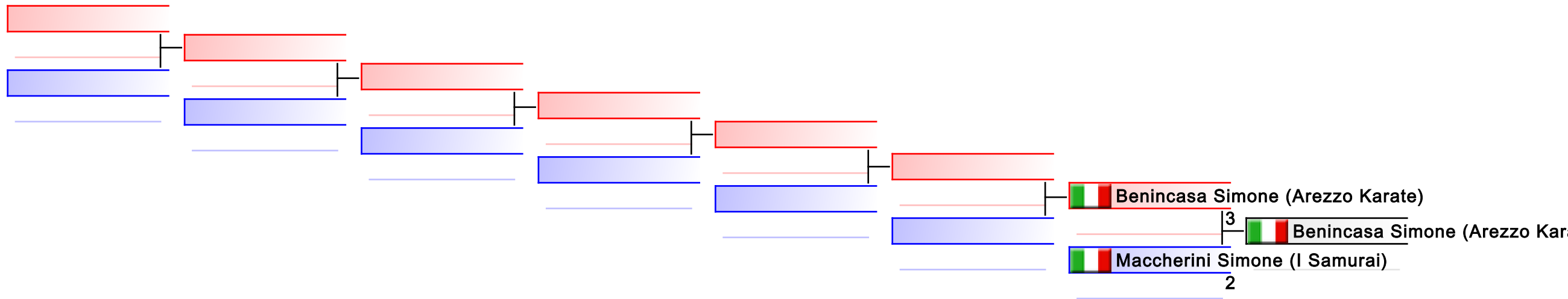

Referees:							
-----------	--	--	--	--	--	--	--